

# Living **large** in your GMC...

---

How to add enough battery power to make life in  
your coach a real joy no matter where you go

by Jerry Work  
GMC Western States/International  
Pueblo, CO 2009

**You can download a copy of this presentation from my website  
<http://jerrywork.com>**

Ample battery power makes for an enjoyable coach experience



It is great to have a fun place to hang out,  
watch a movie or listen to your favorite music



Make it as  
much like  
home as you  
can and you  
will use your  
coach more  
often and  
have more  
fun doing it.





It all started with this guy...



## Alessandro Volta

In 1800 he wrote a letter to the Royal Academy of Science in London describing for the first time how to generate electricity through a chemical process we now call a battery

# What he described

- Volta showed that if you select two dissimilar metals, one with an affinity for giving up positive electrons and the other with an affinity for giving up negative electrons.....
- and suspend them in a chemical that will promote the exchange (an “electrolyte”) then the electrons will naturally flow from one of the metals to the other producing electricity through this chemical process.

# Ok, but what actually is electricity, anyway?

- In the simplest terms electricity is the flow of electrons through a conductor interrupted by a device designed to use those electrons to do useful work for us.
- The pressure with which the electrons are pushed through the conductor is named after our friend Alessandro and is called “voltage”.
- The number of electrons that will fit in a cross section of the conductor is called “amperage”.

# Wattage

- The amount of work the electrons can do is a function of how many pass through the device in a given period of time and how efficient the device is at converting those electrons to do work for us.
- The total number of electrons available is volts times amps or what we call “watts”.
- You can get the same number of electrons to the device with low amperage and high voltage, or with high voltage and low amperage.



# There are many different kinds of batteries

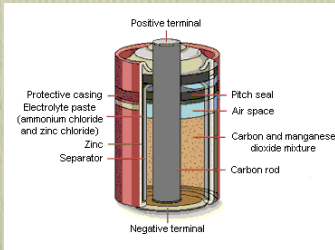

“flash light” battery

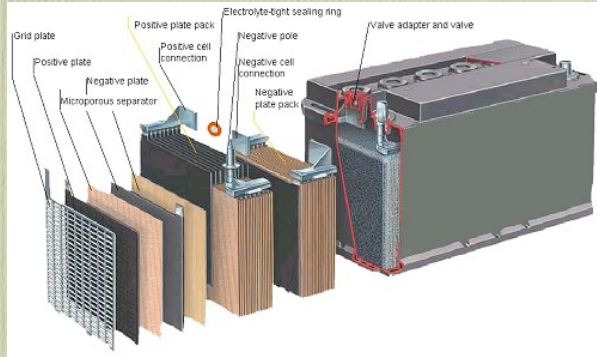

Common automobile battery

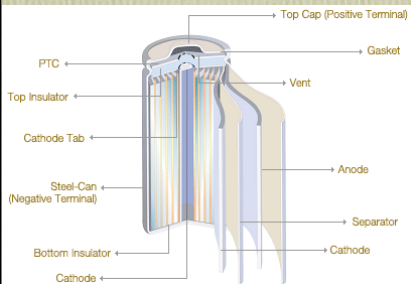

Spiral Wound Cylindrical Cell

# Different metals & electrolytes are use to make different kinds of batteries

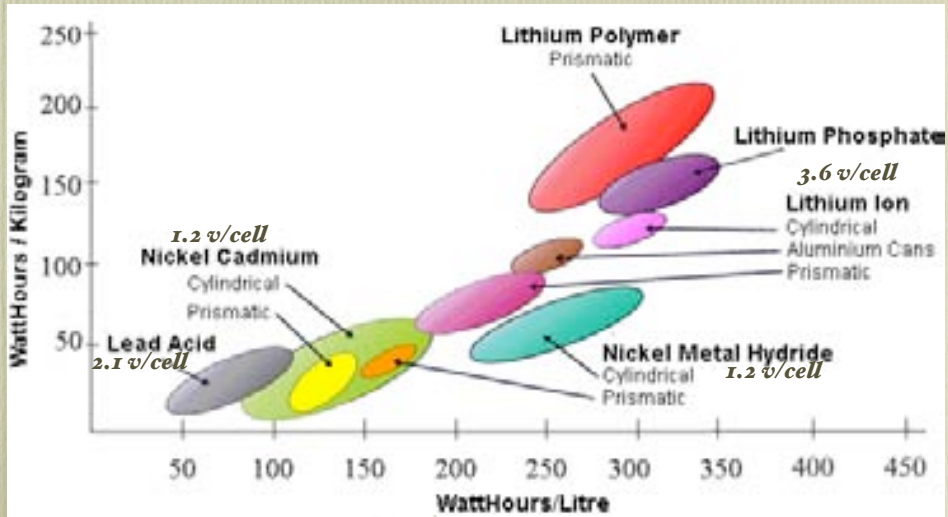

Relative Energy Density of Some Common Secondary Cell Chemistries

# In a lead acid battery the electrolyte is introduced in different ways

- In a typical auto or RV battery the electrolyte is liquid acid so it is called a “wet cell” battery
- Toss a gelling agent into it and it is called a “gel cell” battery
- Fully entrain the electrolyte in a fiberglass matt and it is called an “absorbed glass matt” battery

# Each has its advantages and disadvantages

- A wet cell battery is inexpensive, holds a lot of amp hours of capacity for a given size, but is heavy and makes a real mess if overturned
- Gel cells are less messy, about 50% more expensive and produce 10% or so fewer total amp hours of capacity at the same physical size
- Absorbed glass matt batteries are “spill proof”, very rugged, 2 to 3 times more expensive and produce about 25% fewer total amp hours of capacity at the same physical size.



# Typical auto or RV batteries...

- Produce 2.1 volts per cell. The number of amps is a function of the size and thickness of the metals used to make each cell
- To get higher voltages cells are joined end to end (in “series”) so a 6.3 volt battery is just three cells joined in series, a 12.6 volt is 6 cells. Join two 6.3 volt batteries together in series and you have one larger 12.6 volt battery.
- To get higher amperages, cells (or whole batteries) are joined side by side (in “parallel”). The amperage from each of the cells is added together to get the total amp hour capacity of the battery - or group of batteries - called a “bank”.

# Wiring batteries for more amp hour capacity

These four 12vdc batteries will have four times the ampacity of a single battery which is typically 80-100ah (320 to 400 ah total for these four)

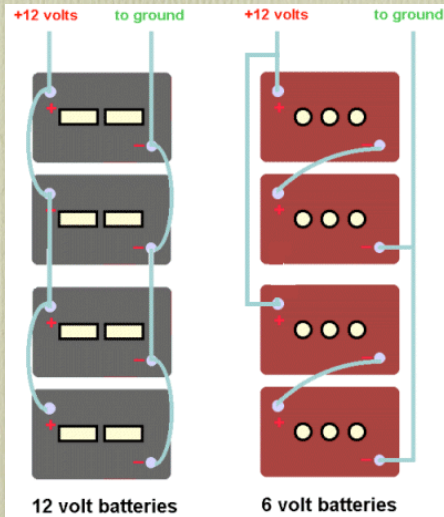

These four 6vdc batteries will have twice the ampacity of a single battery which is typically 210 to 250ah and will last longer (420 to 500ah total for these four)

# Here are pictograms of discharging and recharging

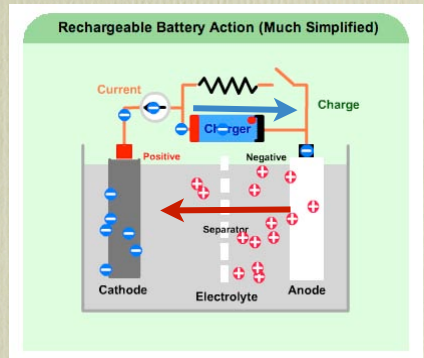
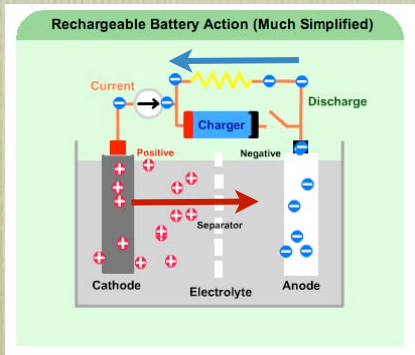

The positive electrons all start out on the cathode and the negative on the anode. During discharge the positive move through the electrolyte and gather on the anode while the negative move through an external conductor to gather on the cathode. Recharging just uses an external source to push them back where they started. ***So, how is that done?***

# We need to introduce another interesting character....



Nikola Tesla (1856–1943), circa 1896.

**Nikola Tesla** (10 July 1856 – 7 January 1943) was an [inventor](#) and a [mechanical](#) and [electrical engineer](#). He is frequently cited as one of the most important contributors to the birth of commercial [electricity](#) and is best known for his many revolutionary developments in the field of [electromagnetism](#) in the late 19th and early 20th centuries. [Tesla's patents](#) and theoretical work formed the basis of modern [alternating current](#) (AC) [electric power](#) systems, including the [polyphase system](#) of electrical distribution and the [AC motor](#), with which he helped usher in the [Second Industrial Revolution](#)



# What he showed....

- While he did not invent the generator, he made it practical.
- If you move a conductor inside a magnetic field, electrons will be “induced” to move along the conductor.
- Wrap wire around a shaft and rotate it inside a magnetic field and you can “generate” electricity continuously, for as long as the shaft turns.
- Hook that conductor to a battery and the induced flow of electrons will chase the positive & negative electrons back to where they started and the battery is “recharged”.
- That is what your alternator does, what your charger does when connected to “shore power” and what your Onan does.

# He also showed.....

- That you could reverse the concept of a generator and use the flow of electrons to turn a shaft - what we call an “electric motor”.
- That electric motor device caused a whole new industrial revolution as electric motors replaced water wheels and steam engines to power everything from machines in factories to the minute electric fans that keep our electronics cool to this day.

# Now we have all three of the things we need to live “large” in our coaches...

- Batteries to provide electricity when and where we need it.....
- Generators to recharge those batteries when they become depleted or discharged.....
- Electric motors, electric lights, AV systems, microwaves & other energy conversion devices, everything we need for a great life on the road.

Let's put the pieces together...

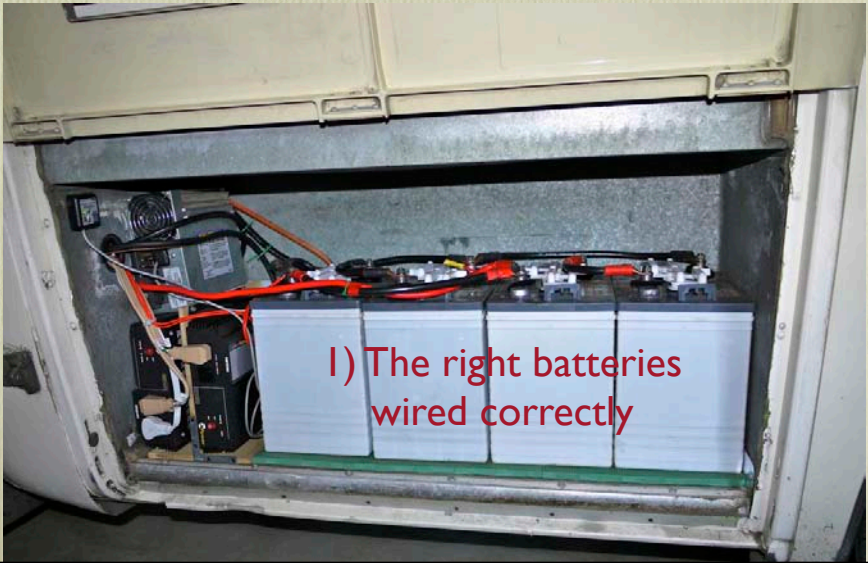

1) The right batteries  
wired correctly



# Let's put the pieces together...

2) a charger/converter to supply 12vdc from a 120vac source to recharge the batteries & power our 12vdc lights, etc.

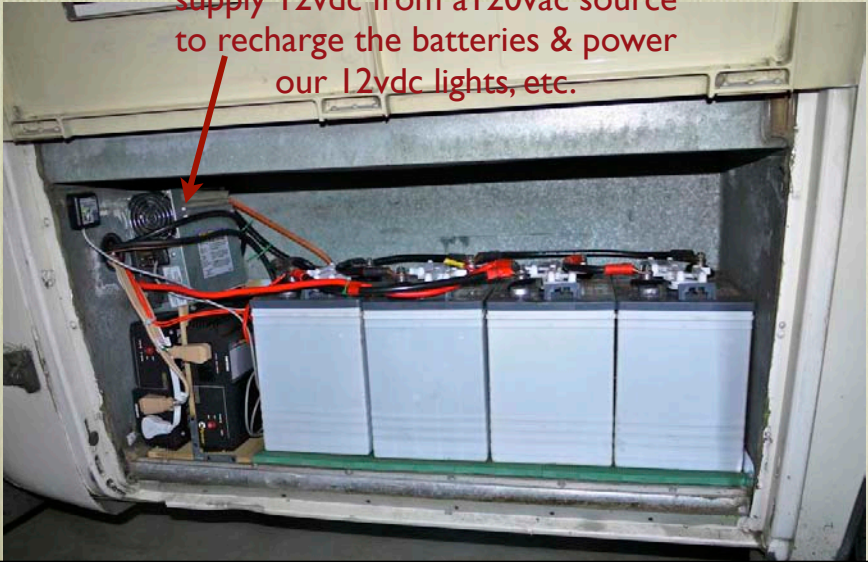

# Let's put the pieces together...

3) an inverter to generate  
120vac from 12vdc to power our  
120vac appliances when we are not  
plugged into shore power

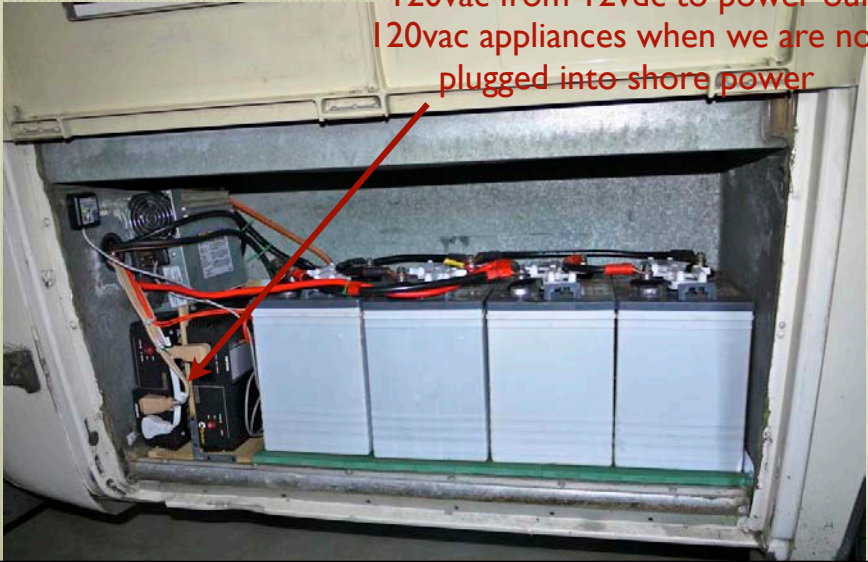

# Let's put the pieces together...



# Let's start with the right batteries wired correctly

- Wet cell 6.3v deep cycle “golf cart” batteries offer the best bang for the buck for use in our coaches.
- They provide 210 to 250 amp hours each
- You need two wired in series to provide 210 to 250 amp hours of capacity at 12.6 volts
- I recommend four. Wire two sets of two in series and then wire those two sets in parallel to provide 420 to 500 amp hours of capacity at 12.6 volts - all you will ever need!





# As we said before, there are other battery types you could also use

## Gel Cell



## AGM

But you pay quite a premium for the additional convenience

# Wire them correctly

- Use 2 gage wire to connect the batteries together. For each set of two, wire the positive terminal on one to the negative terminal on the other.
- Wire the two sets of batteries in parallel by connecting the positive terminals on each set together and the negative terminals together.
- 2 gage wire is available in custom lengths at most auto supply stores or welding supply stores.
- Make sure they solder on the correct connectors which match the posts on your batteries. Do not allow them to just crimp on the connectors as those will eventually fail.

I put all four in the rear, but you can put two forward and two aft if you prefer.

Use 2 gage wire to connect the two sets of batteries together in parallel. Do not use wire smaller than 2 gage.

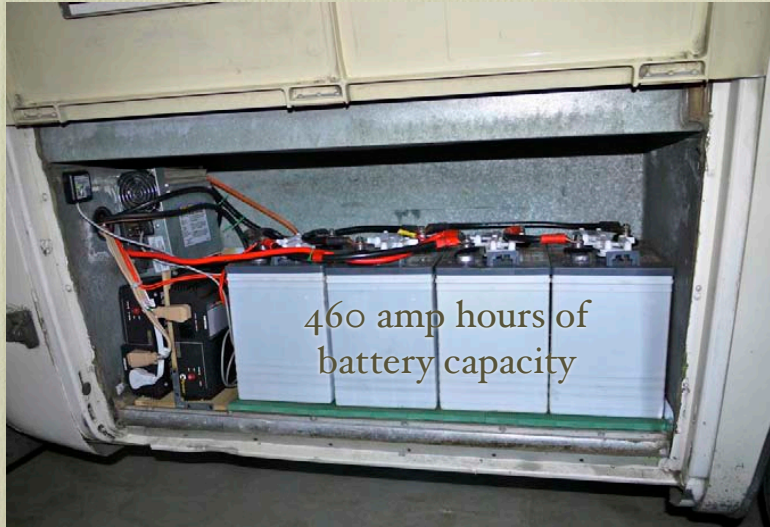

Now select a battery charger/  
converter - there are many good  
brands. Ditch your old “buzz box”



A 45 amp unit is a bit  
too small and costs  
about \$160



A 60 amp unit is  
just right and costs  
about \$200



An 80 amp unit is  
overkill and costs  
about \$250



Be sure to get a  
charge wizard to  
properly control the  
charging cycle



# Wire the converter/charger correctly

- Use 4 gage wire with bare ends to wire to the converter/charger + and - screw clamp posts. Use soldered connectors on the other ends to connect to the + and - posts on your battery bank.
- Also run 8 gage wire from the + and - posts on the converter/charger to your 12vdc coach electrical distribution panel, the coach “fuse” box, if it is within 10 feet. If over 10 feet away, use 6 gage wire.
- This will ensure that you have proper voltage to run all your 12vdc coach lights and appliances.

# Now add an “inverter” to supply 120vac power when you are not plugged into shore power or running your generator

- Select only a name brand as many of the import units are junk and will do more harm than good.
- Ignore the “peak” power rating and only pay attention to the “continuous watt output” rating. Down select by about 25%.
- Your appliances will love you if you purchase a “pure sine wave” unit instead of a “modified” or “square wave” unit.

# Many good brands, capacities & prices to choose from



AIMS 1500 Watt Pure Sine Power Inverter with Built in Transfer Switch & Charger  
Only \$ 599.00



Freedom 458 Inverter/Charger 2000 Watt  
Your Price: \$975.00



**PRO Series Inverters**  
Performance inverters designed for RVs and boats  
Designed for RV and marine electrical systems that already have a battery charger or generator installed, Xantrex PRO Inverters deliver modified sine wave power for small appliances, TVs, and other onboard electronics from a battery bank.



AIMS 1500 watt PURE sine power inverter.  
Clean power. Only \$449! Free wireless remote and shipping.



PROsine 2.0 Hardwire  
Your Price: \$1,475.00



RS2000 Sine Wave Inverter Charger  
Your Price: \$1,275.00



AIMS 300 Watt PURE sine power inverter.  
Includes load based fan and cables. Only \$134!

# Again, use the right wire size

- Wire your inverter with 1000 watts or less continuous capacity with 4 gage wire (will handle 80 amps) from the converter to the battery bank. Use 2 gage wire (will handle 100 amps) if the continuous capacity is up to 1500 watts, and larger wire if the continuous capacity is larger.
- Keep the DC runs as short as possible.
- Use 12 gage 3 wire extension cords to run the AC to your appliances. Those runs can be quite long.
- **Danger!** Do NOT wire the inverter into your 120VAC breaker box unless you really know what you are doing!!!!





I used 2 1000 Watt units (they fit better & provide redundancy) & ran 12 gage extension cords into the coach.

DC voltage drops the longer the run. AC voltage does not, so make all the longer runs on the AC side. Also, 120vac requires only 1/10th the amperage of 12vdc for the same number of watts so you can use much smaller

# Now it is time for the battery monitor - again, lots of good brands



**xantrex**  
Smart choice for power



**Trimetric TM2020**  
Battery Monitor  
System  
about \$150

# Voltage is a lousy measure of battery capacity

- Voltage is only a generally indicative measure, and then only if the battery has been at rest for several hours.
- A real battery monitor uses a very precise resistor called a “shunt” to accurately measure all the amps going out of and into your battery bank.
- With a good battery monitor you know exactly how much charge remains, how much amperage you are currently using , how long before you have to recharge, and much more

# I happened to select the Xantrex LinkPro



Cost is around \$250  
including the correct shunt

It fits well inside our  
GMC coaches

It takes only a simple  
hole to mount

It is very complete  
and easy to use



# The shunt is the key

- One side of the shunt is wired to the negative side of your battery bank with 4 gage wire.
- The other side is where you connect ALL your ground sources for ALL of your DC lights and appliances, your converter and your inverter(s).
- If you have run grounds to the chassis or the aluminum structure, then run from there to the load side of the shunt to make sure you measure all current used or replaced.
- From the shunt to the battery monitor you can use small wire, 16 gage or less.

I put mine just inside the door where it is easy to see



You can see I am currently drawing 10.6 amps per hour out of my battery pack



And I have 89.6% of my useable capacity left.



Current rate of draw



Total used since last recharge



Remaining capacity

Here is the essential info you need



Time to recharge at this rate of usage



Battery voltage - at high rates of draw the voltage will drop

# The only other thing you need is a way to charge all your batteries from any source

- Use a “combiner” (voltage controlled relay) to connect your house and starting batteries together.
- That is much better than the stock or a replacement diode “isolator” which will cause about a one volt drop preventing the batteries from ever becoming fully charged.



I ran a 4 gage wire from the rear house battery bank forward to one side of the solenoid where I could conveniently access the combiner and the chassis battery

Now all my batteries, house and chassis, will recharge from the engine alternator, the Onan generator or from shore power.

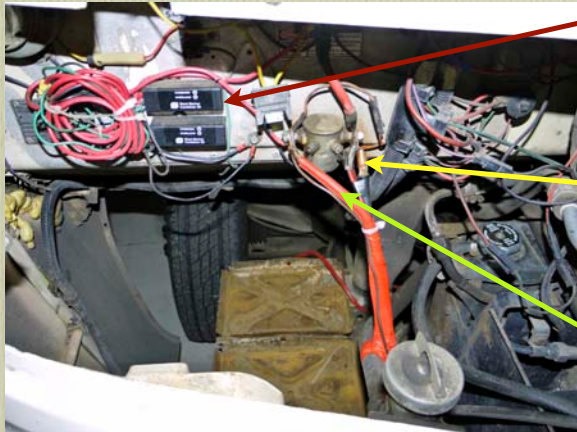

Combiners-one is redundant backup

From starting battery

From rear house batteries

The image shows the interior of a boat, featuring a large, plush, tan leather sofa with tufted cushions. The walls are finished with horizontal wood paneling. Above the sofa, there are two rectangular speakers and a central control panel with a blue illuminated display. The ceiling is also wood-paneled and has recessed lighting. The overall atmosphere is warm and luxurious.

Time now for questions

# Another thing to consider

Line show is for 6v golf cart battery, the curve for a 12v deep cycle battery would be lower and to the left

Battery life drops significantly as you discharge more before recharging

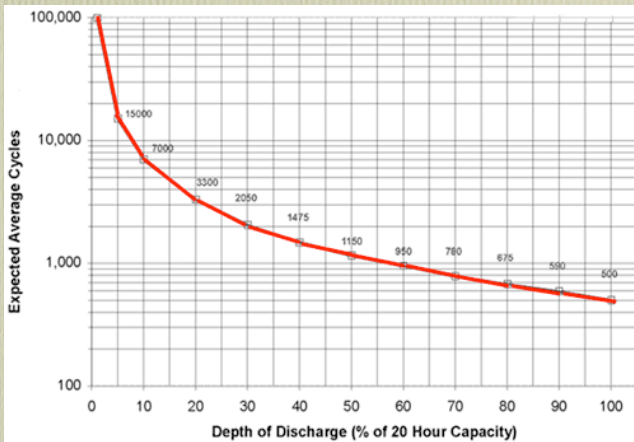

# What about the future?

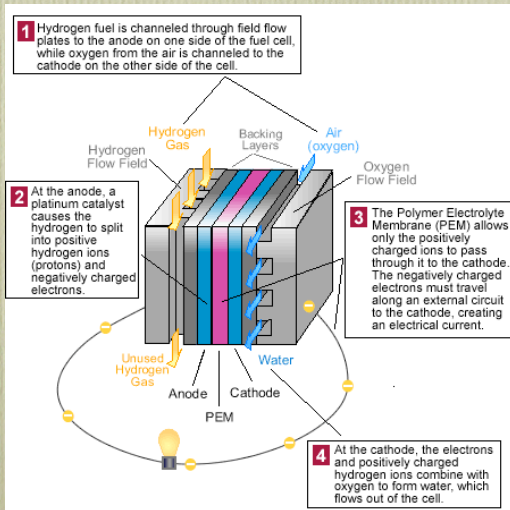

At some point fuel cells may become feasible, but that is quite a long way off as we do not now have a cost effective way to generate hydrogen in sufficient quantity and purity to feed a fuel cell and storing hydrogen gas is quite problematic



# What about the future?

We may sooner see more efficient battery technologies that will allow us to carry more ampacity in a smaller space, but that is far from a slam dunk

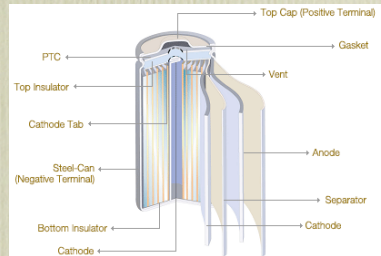
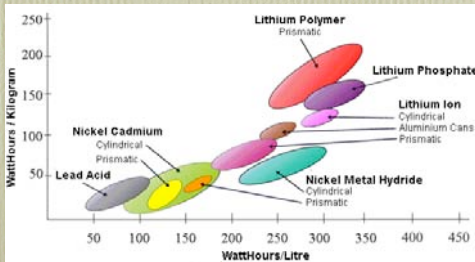

I gained useful space in the process of putting all 4 batteries in the rear compartment



The neat plastic box shown (a Festool "systainer") holds water hoses and tire pressure stuff & sits on top of my knee pad



My 120vac compressor fits neatly over the battery bank, is much faster than 12vdc compressors and runs well off the inverters

The space beside the generator that used to hold batteries now is home for two more Festool “systainers” that hold my jack hooks, gloves, rags, TV cable, power cords and adapters

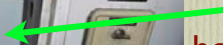

And the space under the rear lounge that used to hold the converter and inverters now houses the rest of my carry along items.

