

EMM

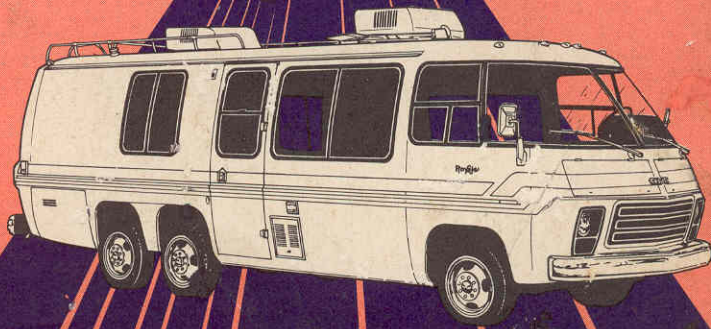

OWNERS MANUAL

FOREWORD

Welcome to Jimmy's ever-growing family of happy recreational vehicle owners, who have been enjoying their units for years. Hours of relaxation, adventure and enjoyment are possible for you in your new Jimmy unit.

This Owner's Manual has been prepared to ensure that you and your family enjoy your new Jimmy RV to its fullest, by providing basic instructions for the operation and maintenance of its appliances, accessories and RV systems. It is supplemented by the Chassis and Body Operating Manual and the appliance and accessory instruction booklets provided by various manufacturers. Read all of the publications carefully and follow the instructions.

Operating and maintenance instructions pertaining to appliances in this Owner's Manual were obtained from and are used with the permission of the various manufacturers. We reserve the right to present edited portions of their material.

Return to your GMC Motor Home Dealer for Guardian Maintenance Service and any other assistance. He is interested in your complete satisfaction and is best qualified to maintain and repair your unit's chassis and body components.

GMC Truck and Coach maintains a number of Zone Offices throughout the country. Should you have a problem that cannot be handled through normal channels, follow the procedure outlined in the Chassis and Body Operating Manual.

Jimmy Motor Homes works year 'round to improve its products. Accordingly, all specifications, equipment, and prices set forth in Jimmy literature are subject to change without notice or obligation.

Jimmy offers a choice of models, floorplans and standard and optional equipment; therefore, certain descriptions in this manual may not apply to your unit. Ask your GMC dealer, or see the current brochure, for information concerning available standard or optional equipment.

ROYALE

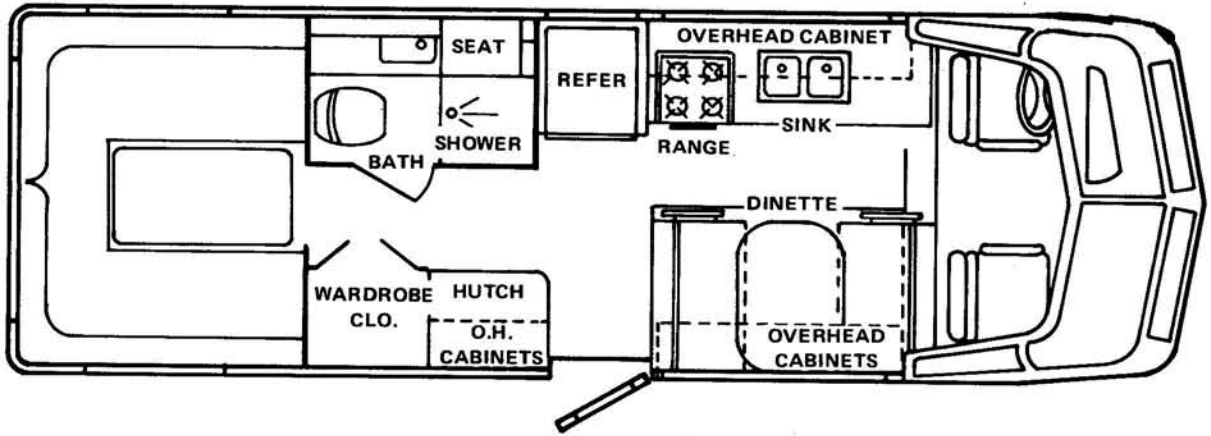

26' SIDE BATH ROYALE w/REAR U-DINETTE

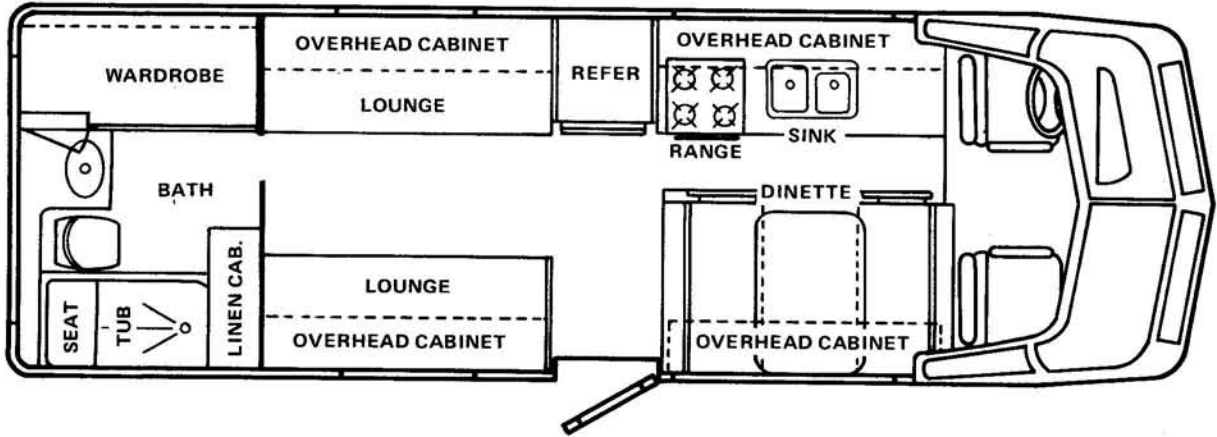

26' REAR BATH ROYALE w/TUB

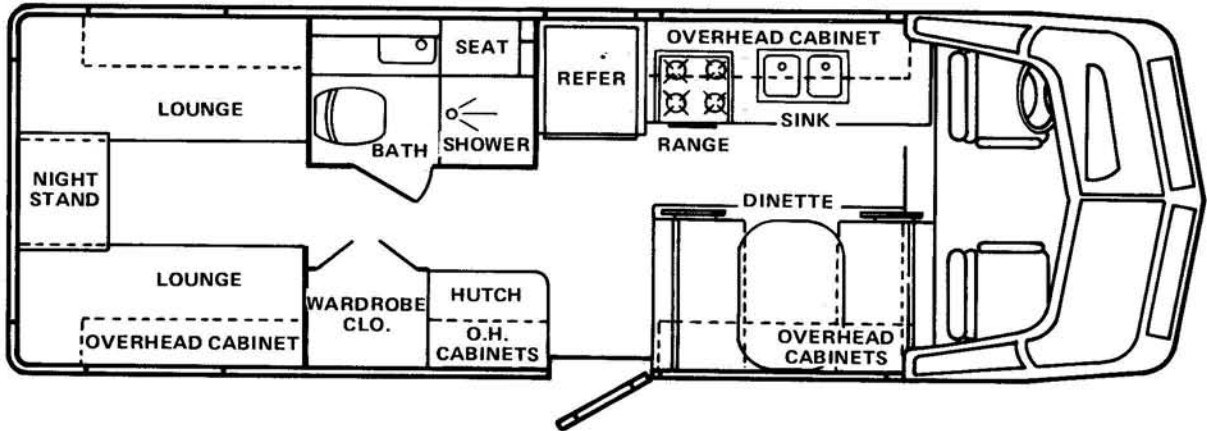

26' SIDE BATH ROYALE w/SHOWER

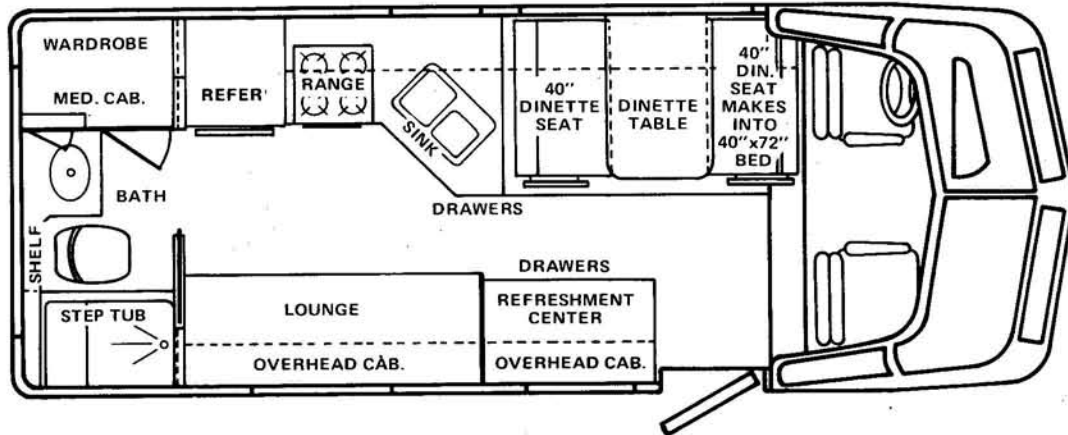

23' REAR BATH BIRCHAVEN w/TUB

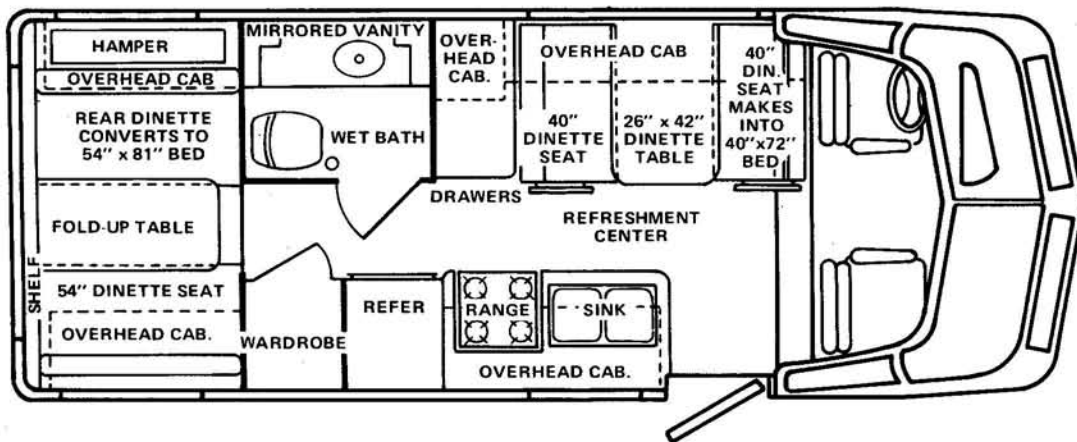

23' SIDE BATH BIRCHAVEN w/SHOWER

TABLE OF CONTENTS

FOREWORD	INSIDE COVER	
FLOOR PLANS	FRONT INSERT	
INTRODUCTION		2
GENERAL		2
LICENSES		2
INSURANCE		2
TRAVEL PREPARATIONS		2-3
GENERAL		2
CLOTHING		2
CAMP HYGIENE		2
PERSONAL HYGIENE		2
SAFETY		2
FOOD AND WATER		2
MEAL PREPARATION		2
TOOL CHEST		3
ADDITIONAL TOOLS		3
EQUIPMENT		3
SLEEPING GEAR		3
ENTERTAINMENT		3
IMPORTANT DOCUMENTS		3
TOURIST INFORMATION		3
GOLDEN AGE PASSPORT		3
GOLDEN EAGLE PASSPORT		3
HOME SECURITY		3
PRE-TRAVEL CHECK		3-4
GENERAL		3-4
LIGHTS		3
REARVIEW MIRRORS		3
WINDSHIELD		3
POWER CORD		3
WATER FILL		3
SEWAGE TERMINATION VALVES		3
WINDOWS AND VENTS		3
TV ANTENNA		3
LP GAS		4
EXTERIOR ACCESS DOORS		4
INTERIOR DOORS AND DRAWERS		4
REFRIGERATOR DOOR		4
AUTOMOTIVE SYSTEM		4
TIRES		4
WHEEL LUGS		4
LOADING		4-5
GENERAL		4
WEIGHT DETERMINATIONS		4
FEDERAL STICKER		4
DEFINITIONS		4-5
GAWR		4
GVWR		4
GVW AND GAW		4-5
WEIGHING		5
DRIVING		5-7
GENERAL		5
PULLING INTO TRAFFIC		5
TURNING		5
PASSING		5
DOWNSHIFTING		5
BRAKING		5-6
GRADES		6
PARKING ON A GRADE		6
FREEDING A STUCK VEHICLE		6
TOWING		6
TILT STEERING WHEEL		6
CRUISE CONTROL		6-7
TIRE CHANGE		7
CAMPING		7
CAMPSITE SELECTION		7
COURTESY		7
LIVING AREA		7-10
SETUP		7-8
TABLES		8-9
WALL MOUNT TYPE		8
PEDESTAL TYPE		8
EXTENSION TYPE		8
THREE-WAY DINETTE SEAT		9
BEDS		9-10
THREE-WAY DINETTE SEAT/BED		9
LOUNGE BEDS		9
SWING-UP BUNK		9
U-SHAPE BED		9
PULL-DOWN BED		10
DIVIDER DRAPES		10
CARE OF CUSHION FABRICS		10
CARE OF DRAPES, CURTAINS		10
CARE OF SHADES		10
CARE OF CARPET		10
CARE OF WOODWORK		10
BASIC SYSTEMS		10
GENERAL		10
ELECTRICAL SYSTEM		10-13
GENERAL		10-11
120-VOLT SYSTEM		11
GROUND FAULT INTERRUPTER		11
SHORELINE CONNECTION		11
12-VOLT SYSTEM		11-12
BATTERY		12
CONVERTER		12
GENERATOR		12-13
FRESH WATER SYSTEM		13-14
GENERAL		13
WATER TANK		13
WATER PUMP		13
SANITIZING WATER TANK		13
CITY WATER		13
WATER PURIFIER		13
CARE OF SINKS, LAVATORY & TUB/SHOWER		13-14
LEAKS		14
DRAINAGE/SEWER SYSTEM		14-15
GENERAL		14
DRAIN CARE		14
TOILET		14
CARE OF TOILET		14
HOLDING TANKS		14-15
EMPTYING HOLDING TANKS		14-15
LP GAS SYSTEM		15-16
GENERAL		15
CLIMATE DIFFERENCES		15
FILLING THE LP GAS TANK		15-16
LP GAS LINE CHECK		16
REGULATOR PRESSURE		16
LP GAS TANK CARE		16
APPLIANCES AND ACCESSORIES		16-21
RANGE, RANGE HOOD, OVEN		16-17
GENERAL		16
LIGHTING THE RANGE		16
LIGHTING THE OVEN		16
BROILER		17
RANGE HOOD		17
CARE OF RANGE AND OVEN		17
CARE OF RANGE HOOD		17
MICROWAVE OVEN		17
CARE OF MICROWAVE OVEN		17
WATER HEATER		17-18
GENERAL		17-18
BURNER ADJUSTMENT		18
DRAINING		18
REFRIGERATOR		18-19
GENERAL		18
LP GAS OPERATION		18
ELECTRIC OPERATION		18
CARE OF REFRIGERATOR		18-19
FURNACE		19
FURNACE IGNITION		19
CARE OF FURNACE		19
VACUUM SWEEPER		19
FOOD CENTER BLENDER		19
ROOF AIR CONDITIONER		20
GENERAL		20
CONTROLS		20
CARE OF AIR CONDITIONER		20
AM/FM/MPX STEREO RADIO & 8-TRACK TAPE PLAYER		20
TV ANTENNA		20
DIGITAL CLOCK		20
MAINTENANCE		21
GENERAL		21
EXTERIOR		21
UNDERBODY		21
AUTOMOTIVE SYSTEM		21
STORAGE		21-22
GENERAL		21
LP GAS SYSTEM		21
WATER TANK		21
WATER PUMP		21
FURNACE		21
ELECTRICAL SYSTEM		22
EXTERIOR		22
INTERIOR		22
WINTERIZATION		22
GENERAL		22
FRESH WATER SYSTEM		22
AQUA MAGIC TOILET		22
FIRE SAFETY		22
EMERGENCY EXITS		22
EGRESS WINDOW		22
SLIDING WINDOW		22
VISITING CANADA OR MEXICO		22-23
GENERAL		22-23
VEHICLES		23
CB RADIO		23
HUNTING AND FISHING		23
DOGS AND CATS		23
EMERGENCY CONTACTS		24
SPECIFICATIONS		25
MAINTENANCE RECORD		26
TRAVEL RECORD		27-28
APPLIANCE IDENTIFICATION FORM		29
EXTERIOR COMPONENTS		30-31

INTRODUCTION

GENERAL

Your selection of a Jimmy motor home indicates that you are a discriminating consumer who appreciates quality and performance, combined with styling; a person who normally does not indulge in impulse buying. However, now that you've purchased your new Jimmy, it's our experience that you may become impulsive about starting on your first trip. We urge that you do not make a hasty departure.

It is true that your Jimmy motor home is ready. The body and chassis were designed and constructed by GMC; the interior was designed by Jimmy Motor Homes and upfitted with the finest materials and components, and the systems have been thoroughly checked by Jimmy and again by your GMC dealer prior to delivery to you. But for complete enjoyment and trouble-free traveling, it is important that you get to know your motor home, its appliances and accessories, how they work and how to take care of them. Make careful plans about what to take and how much. Later, when you are familiar with your motor home and your own travel needs and preferences, those "spur of the moment" trips can be fun.

To help you get started, we have included more than operating and maintenance instructions in this manual; you'll also find tips and suggestions especially aimed at first-time RV'ers. There also are dozens of illustrations for easy identification of the various components.

NOTE: Illustrations identified by a Figure Number will be found in the convenient foldout at the back of the manual.

Our first suggestion is that after you've read this manual, the Chassis and Body Operating Manual, and the appliance and accessory instruction booklets, store them in your motor home for handy reference.

An overnight or weekend "shakedown" trip can help RV'ing novices become familiar with their unit and its systems and appliances. The experience gained and the hints other RV'ers are usually eager to share will help make future trips more enjoyable.

Although you selected certain standard and/or optional equipment, you may wish to add other accessories later. Experience is invaluable in determining which, if any, additional items to choose. Remember, your GMC motor home dealer will assist you in every way possible.

LICENSES

The vehicle licensing laws vary from state-to-state. Check with your license bureau or nearest branch office for the requirements in your state. Be sure to renew your driver's license if it has or will expire during your trip.

INSURANCE

Personal liability, property damage, collision and theft of contents may be features of your auto-

mobile policy which apply to your Jimmy unit. Contact your insurance agent about details of your coverage. Always carry your policy card.

TRAVEL PREPARATIONS

GENERAL

Determine the various items of equipment, clothing, food and other supplies required for the length and destination of your journey. In a subsequent section, the importance of proper loading is explained, but at this stage you're more concerned with a quick getaway. One way to reduce loading time is to purchase dinnerware and silverware, pots, pans, towels and bedding, which can remain in your unit at all times. After a trip, clean and launder the articles and replace them in your motor home, ready for your next trip. The following is a guide to help in your travel preparation.

CLOTHING

Compile a clothing list for each person. Consider the season and areas through which you intend to travel. Basic articles: Underwear, socks, footwear, shirts, blouses, trousers, slacks, dresses, shorts, sweaters, jackets or coats, rainwear and swim suits.

CAMP HYGIENE

Dishsoap, dishcloths and dishtowels, garbage and trash bags, mop, broom and dustpan.

PERSONAL HYGIENE

Toilet paper, soap, washcloths, towels, toothpaste, toothbrush, deodorant, and shaving kit.

SAFETY

Flares and reflectors; flashlight; first aid kit; tow rope and/or chain.

FOOD AND WATER

Don't try to take a food supply for an extended trip. Take enough for two or three days and replenish supplies along the way. Take a basic supply of seasonings: Sugar, salt, pepper and spices. Plan meals so that fresh or refrigerated items are used before they spoil. Fill your fresh water tank before leaving (when traveling in winter, it is recommended that the water tank not be filled until the interior of your unit is thoroughly warmed or until you reach your destination).

MEAL PREPARATION

Bottle cap and can opener; matches, lighter or igniter device; pots, pans, plates, glasses, and cups (paper or plastic are lighter and less likely to break while the vehicle is in motion); silverware and carving knife.

TOOL CHEST

Include an assortment of wrenches and screwdrivers, pliers, hammer, shovel, tire pressure gauge, small level, electrical and masking tape (for changing rear tires, you'll need a Phillips screwdriver and a 9/16" wrench to remove the fender skirt).

ADDITIONAL TOOLS

You also may want to take a hatchet, saw, and 12-volt portable tire pump.

EQUIPMENT

Fresh water hose (garden) and bucket; "Y" type water hose fitting; 20-foot, 3-prong power cord; 3-prong adapter with grounding wire; fuses; wheel chocks, leveling ramp or blocks.

SLEEPING GEAR

Sleeping bags are ideal for cold climates, but sheets and blankets are better suited for warm weather. Take along an extra blanket or two for sudden drops in temperatures, such as can be expected in mountain areas even during summer. Be sure to take pillows, pajamas and mattress pads, if normally used.

ENTERTAINMENT

Take along games, toys, books, magazines, or other items of entertainment to occupy passengers while traveling or in case you encounter inclement weather.

IMPORTANT DOCUMENTS

Carry your vehicle registration and insurance policy card(s). If you are borrowing a vehicle, you should have a notarized letter of authorization from the owner with you.

TOURIST INFORMATION

Current road maps and tourist information for states through which you intend to travel are available through state tourist agencies. You also may want to purchase a tourist guide book.

If you will be visiting federally-operated national parks, monuments and recreation facilities, you may wish to look into the Golden Age Passport and the Golden Eagle Passport. They can help families cut spending at those areas where fees are involved.

GOLDEN AGE PASSPORT — The Golden Age Passport is free for persons 62 and over and covers all admission fees and a 50 percent discount on use fees (except fees charged by private concessionaires) and is good for lifetime. It may be obtained only at park service offices and at parks where entrance fees are charged. It cannot be obtained by mail or at post offices. To obtain the Golden Age Passport you will need proof of age, such as a driver's license, or be prepared to sign an affidavit swearing that you are 62 or over. Note: Medicare cards are

not accepted since in some cases they are issued to younger persons.

GOLDEN EAGLE PASSPORT — The Golden Eagle Passport costs \$10 and is designed for persons who plan to visit several parks or federally-operated facilities in a single year. It covers all admission charges but does not cover use fees and is good only during the calendar year in which it is issued. It may be purchased in person or by mail at the National Park Service headquarters, Department of the Interior, Washington, D.C. 20240; at regional offices and at facilities where entrance fees are charged.

Both the Golden Age and Golden Eagle Passports cover admission fees for the permit holder and any persons accompanying him or her in a private vehicle. Where entry is not by vehicle, the passport covers the permit holder and members of his or her immediate family.

HOME SECURITY

Make arrangements for someone to check your house periodically. Stop mail and newspaper delivery. If you intend to be away for more than 2 weeks, request police surveillance. Carry an extra set of vehicle and house keys on a separate key ring.

PRE-TRAVEL CHECK

GENERAL

Whether departing from your home, rest area, or campsite, you should perform these pre-travel checks:

LIGHTS should be tested, including brake lights, warning flashers, clearance lights, taillights, turn signals and headlights. Clean all lens covers.

REARVIEW MIRRORS should be adjusted so the driver can see both sides of the unit.

WINDSHIELD should be clean, wiper blades inspected, and windshield washer reservoir filled.

POWER CORD (120-Volt Shoreline) must be unplugged from the external source, pushed into its compartment and the cord hatch secured.

WATER FILL hoses must be disconnected and the caps secured.

SEWAGE TERMINATION VALVES must be closed and locked. The sewer hose must be removed from the termination valve outlet and stored. The termination cap(s) must be securely fastened to the termination outlet(s).

WINDOWS AND VENTS should be closed and secured (the two rear windows should remain closed while driving to avoid drawing exhaust fumes into the vehicle).

TV ANTENNA must be cranked down to its travel position.

LP GAS tank and gas line connections should be checked.

NOTE: Some states prohibit vehicles equipped with LP gas tanks from using tunnels. A few other states prohibit traveling with the Service valve open and the pilots lit. Check the regulations of the states through which you intend to travel.

EXTERIOR ACCESS DOORS for storage and equipment should be closed and locked.

INTERIOR DOORS AND DRAWERS should be locked and secured. Loose items should be lashed down or stored away.

REFRIGERATOR DOOR should be secured with the travel latch.

AUTOMOTIVE SYSTEM should have the pre-travel check outlined in the Chassis and Body Operating Manual.

TIRES should be inspected before each trip. Replace a tire when it is worn to 1/16" depth in two or more adjacent grooves, or to the level of tread indicators molded into the bottom of the tread grooves, when the indicators appear in two or more adjacent grooves at three locations around the tire. Check tire for uneven wear, road damage, foreign objects, or excessive peeling or bulging.

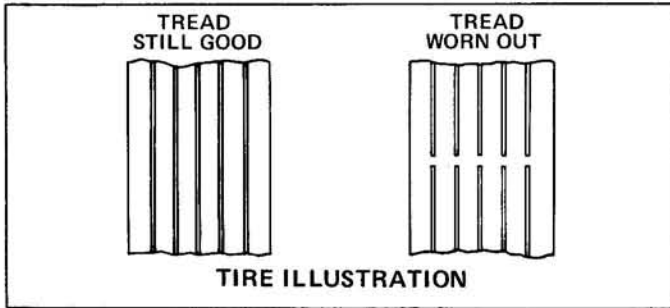

When purchasing a new tire, be certain it is the same size and has the same ply rating and load range as the old tire. DO NOT mix radial ply with bias-belted tires.

Each morning inspect tire condition and pressure on your unit. Heat generated by surface friction will increase the tire's air pressure approximately 6 to 9 psi; therefore, do not bleed air out of a hot tire. Inflate tire to recommended pressure as indicated on tire or in tire manufacturer's instruction booklet.

NOTE: Proper tire inflation is extremely important.

WHEEL LUGS must be tightened to the specifications in the Chassis and Body Operating Manual.

LOADING

GENERAL

A properly-loaded vehicle will perform better

and handle more safely. Distribute your cargo evenly from side-to-side and front-to-back. Store heavier items on or close to the floor and as centrally as possible. Lighter items may be stored in cabinets, closets and drawers. Luggage or similar cargo transported inside your motor home should be secured to prevent them from causing damage in case of a sudden stop or accident. Remember to leave space and weight allowance for souvenirs or other items you may purchase during your travels.

WEIGHT DETERMINATIONS

It is extremely important that you weigh your vehicle prior to leaving on a trip to determine whether your cargo is within the allowable limits for the various suspension components. Check the Federal Sticker, the Chassis and Body Operating Manual, or the Vehicle Identification Number (VIN) Plate for the maximum weight ratings of each axle and the proper tire inflation for the intended load.

FEDERAL STICKER

Found on the panel at left of driver area, the Federal Sticker lists the Jimmy Serial Number, the front and rear Gross Axle Weight Rating (GAWR) and the Gross Vehicle Weight Rating (GVWR). The VIN Plate is under the hood of the curb-side firewall. It also lists the GAWR, GVWR and the Chassis Serial Number.

MFD BY **Coachmen Industries, Inc.** DATE _____
INC. VEH. MFD BY DATE _____
GVWR _____
GAWR _____
FRONT TIRE _____ RIMS @ _____ PSI
INTER-MEDIATE WITH _____ RIMS @ _____ PSI
REAR WITH _____ RIMS @ _____ PSI Cold Single
PSI @ _____ PSI Cold Dual

THIS VEHICLE CONFORMS TO ALL APPLICABLE FEDERAL MOTOR VEHICLE SAFETY STANDARDS IN EFFECT IN:

VEHICLE I.D. NO. _____
VEHICLE TYPE MULTIPURPOSE PASSENGER VEHICLE MODEL _____

FEDERAL STICKER

DEFINITIONS

GAWR — The allowable weight, including cargo and passengers, which can safely be supported by the axles.

GVWR — The maximum permissible weight of your vehicle, including cargo, all options and passengers.

GVW AND GAW — Are found by weighing the vehicle fully-loaded. GVW is the actual weight of the motor home and all standard and optional equipment, cargo and passengers. GAW is the portion of the fully-loaded vehicle which is transferred to the axle(s).

You can weigh your vehicle at a grain elevator, sand and gravel dealer or government weighing

station (they are listed in the yellow pages of your telephone directory). The small fee involved may save you considerable trouble and expense later. Be certain to weigh the motor home with all passengers, cargo, LP gas and water aboard.

WEIGHING

STEP 1 — Drive only the front axle of the motor home onto the scale. Compare the weight to the front GAWR listed on the Federal Sticker.

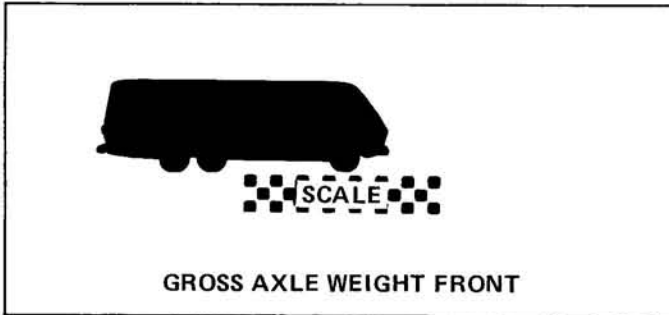

STEP 2 — Pull forward so that the front and rear axles are on the scale. Compare the weight to the GVWR listed on the Federal Sticker.

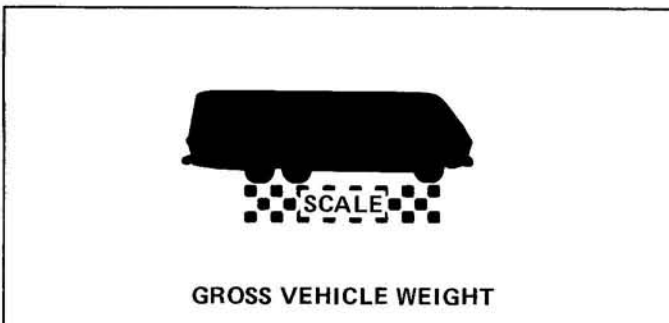

STEP 3 — Pull forward so that only the rear axles are on the scale. Compare the weight to the rear GAWR listed on the Federal Sticker.

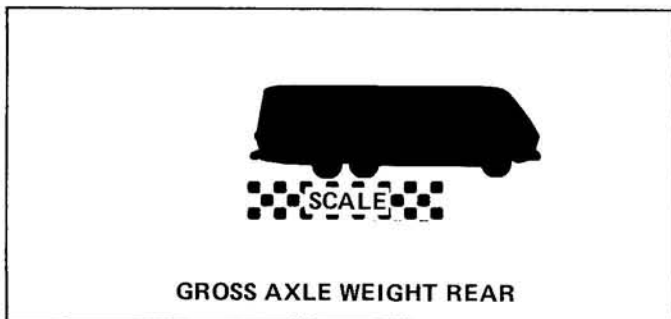

NOTE: If any of the weight ratings are exceeded, shift or remove a portion of the cargo and re-weigh the vehicle.

The independent suspension on your motor home could be adversely affected by an unbalanced load on either side of the vehicle. The allowable front lateral weight variation is 250 pounds. The allowable rear lateral weight variation is 600 pounds. Lateral

weight variations in excess of those figures may result in abnormal vehicle handling.

DRIVING

GENERAL

Power steering and power brakes help make driving your Jimmy motor home as effortless as possible. But you must remember that the motor home is longer, higher and wider than a family automobile. Be especially watchful for low bridges, overpasses, awnings or similar obstructions, which might damage your roof or accessories mounted on the roof. Watch for overhanging tree branches which also can do considerable damage to the windshield or roof of your motor home (refer to the brochure for clearance measurements). Before leaving on a trip, you may want to practice turning, braking, backing and accelerating.

PULLING INTO TRAFFIC

Check for oncoming traffic in all directions. Signal before entering the traffic flow. Accelerate slowly and smoothly and remember to compensate for less acceleration than that of a vehicle with a higher power-to-weight ratio.

TURNING

Because of the length of your Jimmy motor home, always pull farther ahead before turning either left or right to allow sufficient clearance for the rear of your vehicle.

PASSING

Avoid sudden maneuvers when passing another vehicle. Remember that additional time and distance are required to pass safely. Wait until the road is clear of oncoming traffic for at least 1/2 mile. Check the rearview mirrors and signal lane change before passing. When you are safely ahead of the other vehicle, signal lane change and return to your original lane.

DOWNSHIFTING

When additional acceleration is desired to pass moving vehicles or to climb steep grades between 35 and 65 mph, the transmission can be downshifted by depressing the accelerator pedal completely to the floor. You also can downshift in Drive (D) range at speeds under 35 mph by depressing the accelerator pedal part way down.

BRAKING

Allow a safe distance in which to stop your motor home. Never follow another vehicle closer than one vehicle length for each 10 mph. Pump the brake pedal lightly to stop on wet or icy roads. If you start to slide, turn the steering wheel in the direction of the slide. DO NOT tromp the brake pedal — a panic stop will increase the slide. DO

NOT rest your foot on the brake pedal when you are not intending to stop. "Riding" the brakes will waste gasoline and can cause excessive brake temperatures, lining wear and possible brake failure.

GRADES

Before descending steep or long grades, reduce speed and shift into a lower gear. The selector lever may be moved to Low (L) at any speed, but the transmission will only shift automatically into Low range when the vehicle speed is under 40 mph. The transmission will not upshift from Low range as long as the selector lever is in the (L) position. Super range (S) can be used when increased acceleration is needed in traffic, hill climbing or "engine braking" on down-hill grades. The selector lever may be moved from (D) to (S) and vice versa under most operating conditions. Super range should not be used at speeds above 75 mph.

Reducing speed and shifting to a lower gear before climbing or descending steep grades can prevent engine overheating. If your vehicle's engine should overheat, pull well off the road, shift to Neutral (N), and run the engine with your foot resting lightly on the accelerator pedal. If the engine does not cool within 5 minutes, turn it off and locate the problem before continuing on your trip.

PARKING ON A GRADE

Always apply the foot brakes then set the parking brake, when parking on a grade, before moving the shift lever to Park (P). When preparing to move the vehicle, move shift lever out of Park (P) before releasing parking brake. If this sequence is not followed, you may not be able to move the shift lever out of Park (P). If this torque lock does occur, you may have to have another vehicle push yours a short distance until you can move the shift lever.

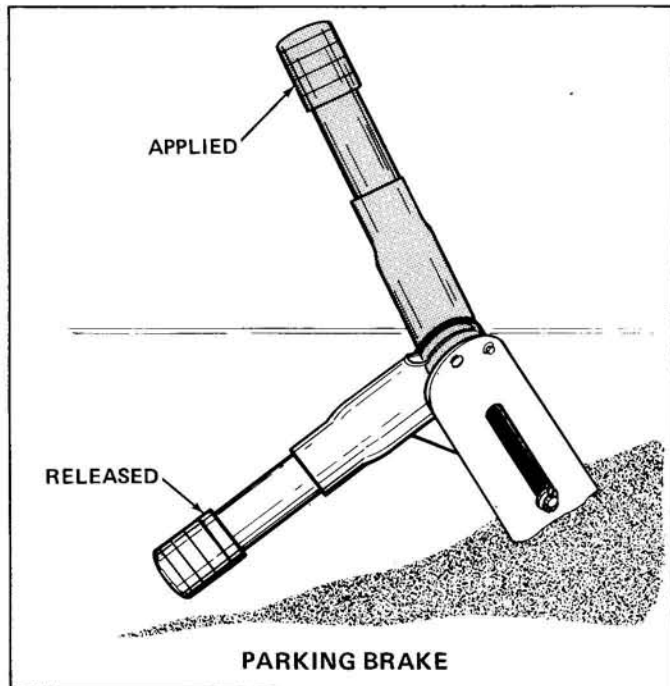

FREEING A STUCK VEHICLE

To pull your vehicle out of snow, sand or mud, apply slight pressure to the accelerator pedal and move the gear selector lever rhythmically between Low (L) and Reverse (R). If possible, keep the front wheels pointed straight ahead. Avoid sharp turns. Once the vehicle starts to move, do not stop until it is on firm ground.

CAUTION: DO NOT race the engine or spin the wheels; prolonged efforts to free a stuck vehicle may result in overheating and transmission and axle failure.

TOWING

Towing a trailer will affect handling, durability and economy. Maximum safety and satisfaction depends upon proper use of correct equipment and avoiding overloads and other abusive operation. For more information on towing, see the Chassis and Body Operating Manual – Trailer Hauling.

TILT STEERING WHEEL

The tilt steering wheel can be moved above the normal position to allow additional room for entrance and exit, as well as selected driving positions above and below normal height. Operate the tilt mechanism by lifting the small control lever, on the left side of the steering column just below the directional signal lever, then moving the steering wheel to the selected position and releasing the lever.

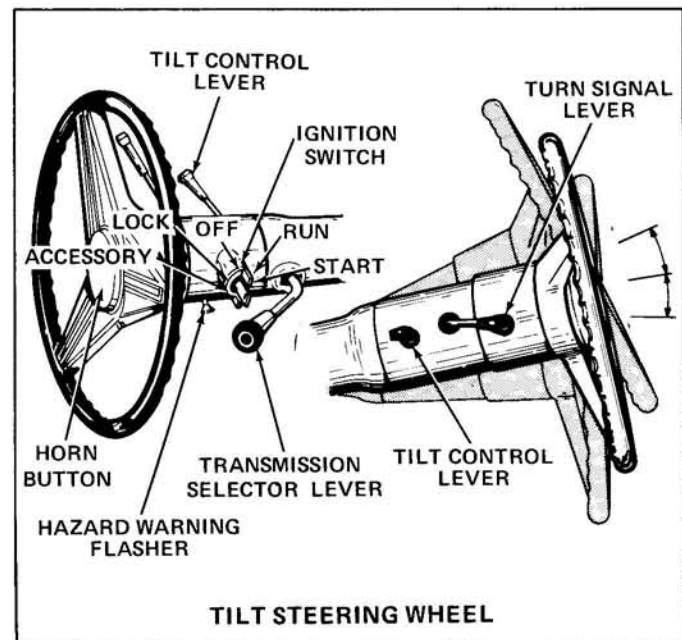

CRUISE CONTROL

The Cruise Control, located in the end of the turn signal lever, is designed to allow the vehicle to hold a selected speed at 30 mph or higher. To activate, accelerate to the desired speed and push in the engagement button momentarily; take your foot off the accelerator and the speed will be maintained. To reset at higher speed, accelerate to the desired speed, push in the engagement button

fully and release slowly. To reset at slower speed, depress the engagement button fully and hold. Allow vehicle to decelerate until desired speed is reached, then release engagement button slowly. You can increase your speed, such as for passing, by depressing the accelerator pedal. When you let up on the accelerator, the vehicle will return to the pre-set speed. Lightly apply the brake pedal to disengage the system.

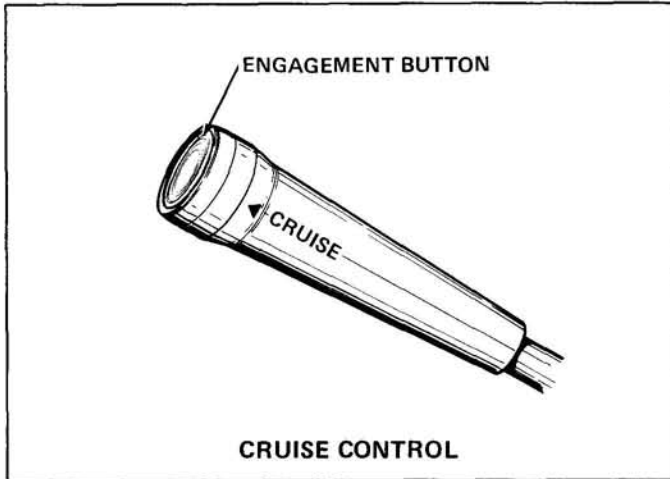

CAUTION: Do not use the Cruise Control when conditions are not suitable for maintaining a constant speed, such as in heavy or varying traffic or in strong winds or on slippery roads.

TIRE CHANGE

Change a tire on as level and firm a surface as possible. If you are on the road side, activate the vehicle's hazard warning flashers. Apply parking brake and move transmission selector to Park (P). Set up flares and/or warning lights and block both front and rear of the wheel diagonally opposite the jack position. Loosen, but do not remove, the lug nuts.

Remove jack from its storage area (either under the rear facing dinette seat or davo seat, located behind the front passenger seat).

To change a front tire, place hydraulic jack on a wood block near the front bumper bracket. Place hook at flange front crossmember. Pass chain under bumper (place a pad over bumper to prevent marring it) and adjust chain length to snug fit on fork at top of jack. For a rear tire, remove fender skirt using a Phillips screwdriver and a 9/16" wrench or socket. Place jack on wood block close to the rear suspension bracket. The hook is placed in the drainage slot under the bracket. Adjust chain length so link will fit in fork at top of jack.

To raise jack, close valve at base, insert jack handle and pump with slow, smooth motion. Raise vehicle until tire just clears surface. Remove lug nuts, slide tire off and replace with spare. Slightly tighten lug nuts. To lower jack, open valve at the base of the jack, then fully tighten the lug nuts.

Have lug nut torque checked at earliest opportunity. Proper lug nut torque is 250 foot-pounds.

CAUTION: Use the jack only for changing tires. Never get beneath the vehicle when using the jack; never start or run the engine while vehicle is on the jack. Always securely stow the spare tire on the spare tire carrier and return all jacking equipment to its proper storage area.

CAMPING

CAMPSITE SELECTION

Because of the rapidly growing number of recreational vehicles, some campgrounds do not accept reservations, but make one whenever you can. If possible, arrive early so you may inspect and choose a site during daylight hours. Try to avoid sites near a swamp, stream or other bodies of water which may harbor mosquitoes or other insects. Avoid parking under dead trees or loose limbs which might fall and cause injury or damage. Stay away from areas which show signs of flash flooding. DO NOT park on private property without first obtaining permission.

In winter, park behind a grove of trees, bushes or similar type of windbreak. Close the gap between the ground and the bottom of your vehicle's outside walls with plastic, canvas or similar material. This will cut down cold drafts which can affect interior temperatures.

COURTESY

Common courtesy will help make your stay more pleasant. Campsites are often close together and RV walls are not as thick as those in your home, so loud noises may disturb your neighbors. Follow the posted rules of the campsite. Open fires may not be permitted. If you can build a campfire, clear the area of flammable materials; never leave a campfire untended and always make certain the embers are completely extinguished.

LIVING AREA

SETUP

You'll want your motor home to be level for your own comfort (you don't want items sliding off counters and tables or out of cabinets). But more important, the unit must be level in order for your refrigerator and drainage system, both of which function by gravity, to operate properly. Place a level on the bottom of the refrigerator freezer compartment or in a normally level location inside the vehicle to determine proper levelness. Bubble levels are furnished with some refrigerators and are available from your GMC dealer.

The Electro-Level system can level your vehicle from side-to-side and front-to-back by raising or lowering either side of the rear of the vehicle approxi-

mately 4 inches from normal ride height. The Electro-Level control panel is located to the left of the driver below the window.



ELECTRO-LEVEL CONTROL PANEL

The two RAISE-LOWER switches may be used as necessary to raise or lower the vehicle. The engine need not be running, but the ignition switch must be in the ON or ACCESSORY position. To raise the vehicle, place appropriate rocker switch in the RAISE position until desired height is reached, then return rocker switch to OFF. To lower the vehicle, place appropriate rocker switch in the LOWER position until desired height is reached, then return rocker switch to OFF. (It is possible that the air compressor may operate for a short period when a rocker switch is in LOWER position.) When both sides of the vehicle have been leveled, be sure the TRAVEL switch is moved to HOLD and turn ignition switch to OFF.

When you resume traveling, if leveling system was used, place center rocker switch in AUTO position for approximately 5 minutes, then move the switch to HOLD after ride height has been achieved. The HOLD position is to be used for normal highway driving. If the leveling system has not been used, it is not necessary to place TRAVEL switch in AUTO when you resume traveling.

When traveling off the road, both RAISE-LOWER switches should be in RAISE position to allow maximum ground clearance. It is recommended that you not exceed 15 mph in this position since the air suspension has maximum pressure.

A "Set Level to Travel Auto" reminder light in the dash panel will come on any time the engine is running and the transmission selector lever is moved to Drive (D) range (see the Chassis and Body Operating Manual for emergency operation and maintenance instructions for the suspension and leveling systems).

NOTE: When the unit has been leveled side-to-side and front-to-back, you may wish to permanently attach levels inside near the driver, on the sidewall and dash panel. This will allow you to tell at a glance if you've stopped on a level site and will help speed up the leveling process.

TABLES

WALL MOUNT TYPE — To install the wall mount type table, raise the front edge about one

foot above the wall mount rail. Hook table rail onto the wall rail (both ends of the table rail are crimped to prevent the table from sliding off). Release table leg by depressing latch, pull the leg down until it catches in upright position. Travel leaves may be folded up when traveling to provide recessed coasters for holding cups or glasses. To increase table surface, extend the supports (two per leaf) and unfold leaf.

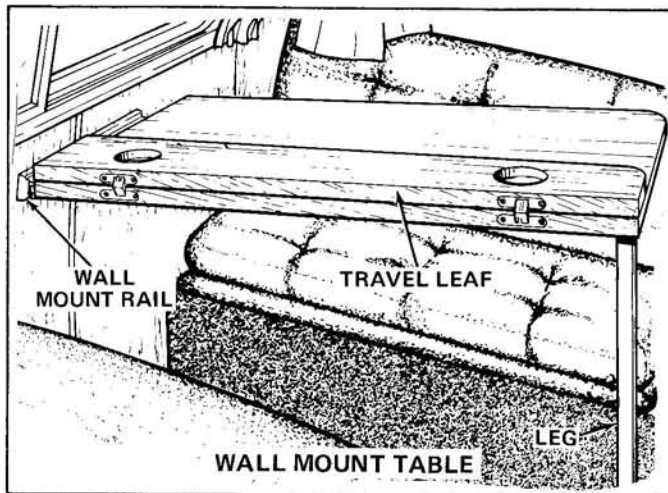

WALL MOUNT TABLE

PEDESTAL TYPE — Remove plug from floor base and insert table leg. Lower table support bracket onto the leg. The pedestal table also has foldout leaves with recessed coasters for cups or glasses. When the table leg is not being used, store it and replace floor base plug.

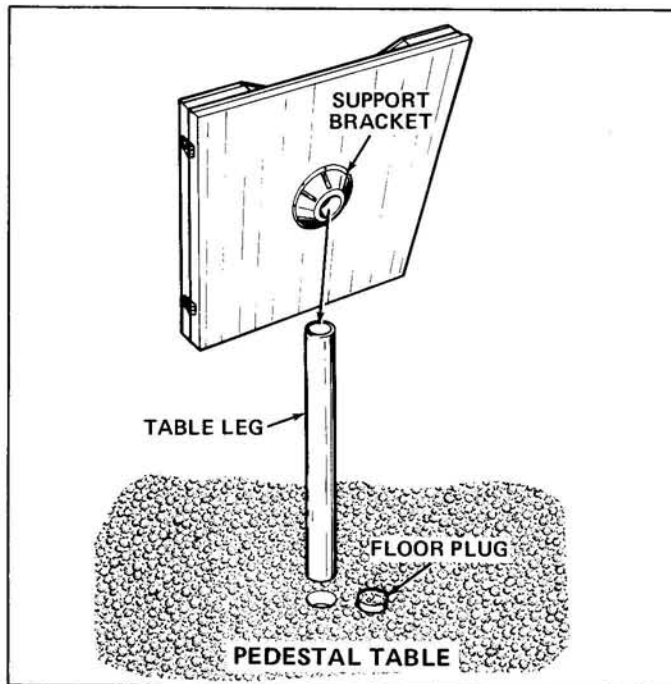

PEDESTAL TABLE

EXTENSION TYPE — Unfasten travel latch. Swing table up and release table leg by depressing lever; swing leg down to the locked position. Release the latch located under the table. Pull out the sliding portion of the table. Insert leaf(s) and push table together.

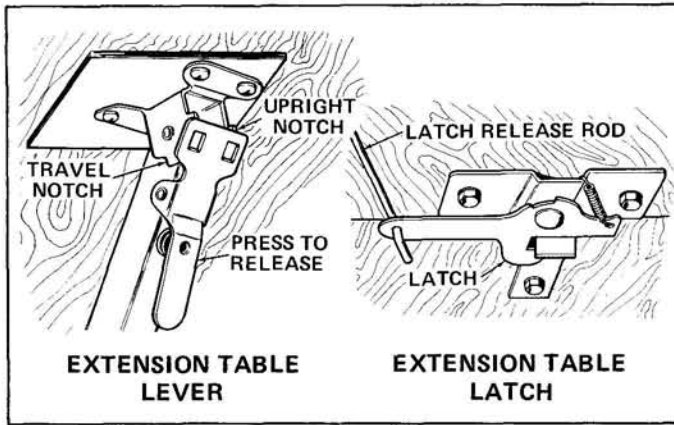

THREE-WAY DINETTE SEAT — To change seat direction, pull out the handle; lift and rotate backrest to face in other direction. Press down on seat and push in on the handle. Test the seat to make sure it is locked in place. The front dinette seat is not designed to be occupied while traveling.

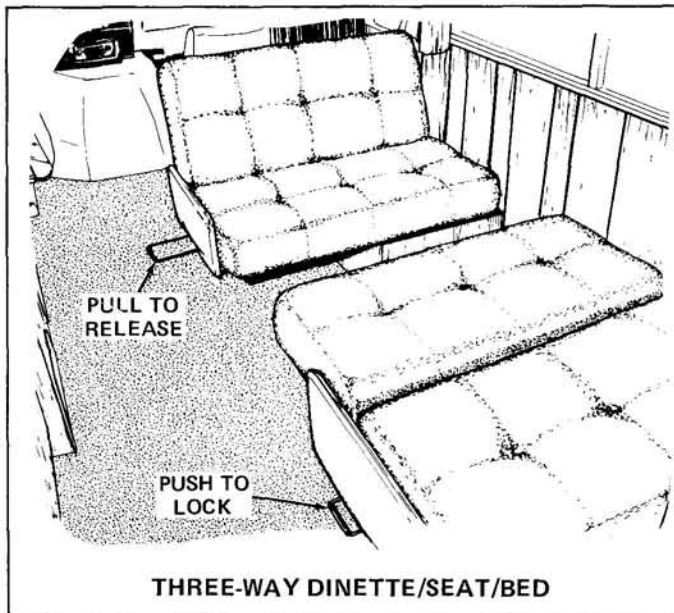

BEDS

THREE-WAY DINETTE SEAT/BED — To make the three-way dinette into a bed, remove the dinette table. Be certain the seats are in the table set-up position. Pull out the handle and push down on the backrest. Push the handle back into the locked position. Repeat this procedure on the opposite seat to assemble the other half of the bed.

LOUNGE BEDS — The seat portion of the lounge in 26' SB and 26' RB models are twin beds, ready for use. After unfastening the snap button, the front edge of the lounge in the 23' RB model can be lifted and the legs beneath pulled down and locked into place to make a wider bed. The facing lounges in the 23' SB operate the same way and when extended, join to make one large bed (the extension table first must be lowered and latched in its travel position).

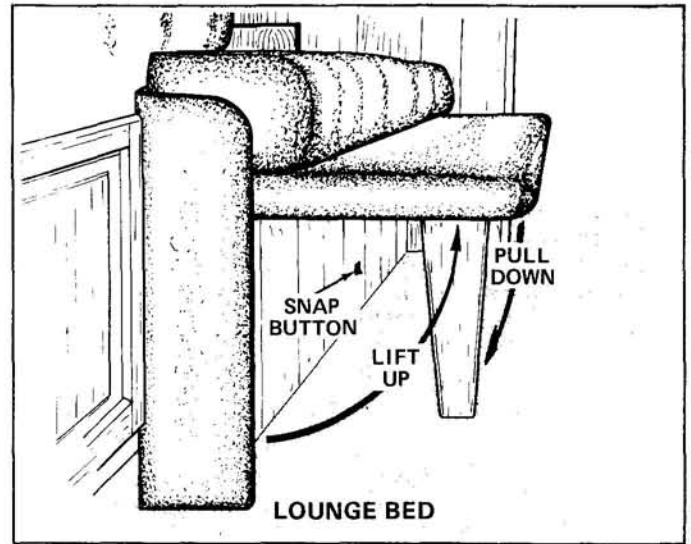

SWING-UP BUNK — The back of the lounges in 23' RB and 26' RB models, lift up and fold out to form an upper bunk. Insert the support straps into the recessed holding brackets in the ceiling.

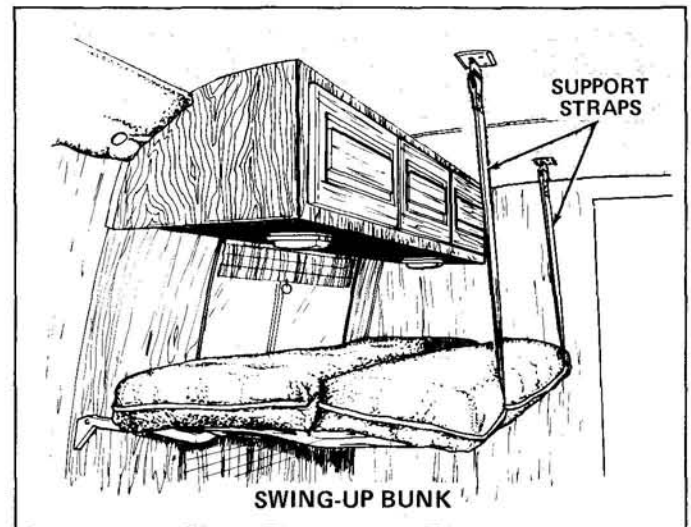

U-SHAPE BED — The U-shape dinette converts into a large bed. Remove the pedestal table, place it on the seat supports and arrange cushions on top.

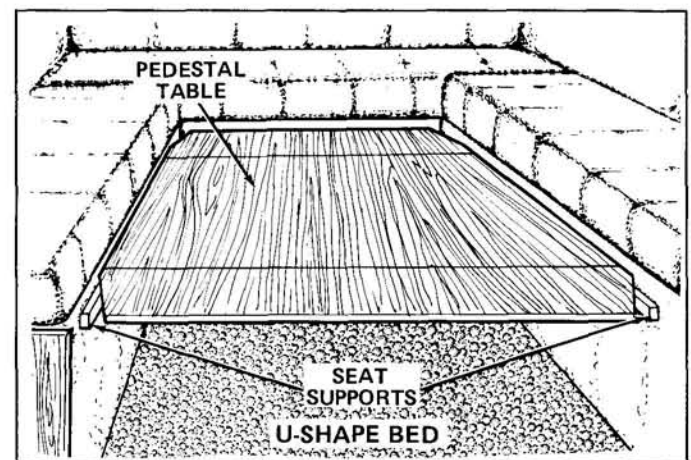

PULL-DOWN BED — To use the pull-down bed (optional in 23' SB model), unfasten the latch and pull down and push until the bed is locked into place.

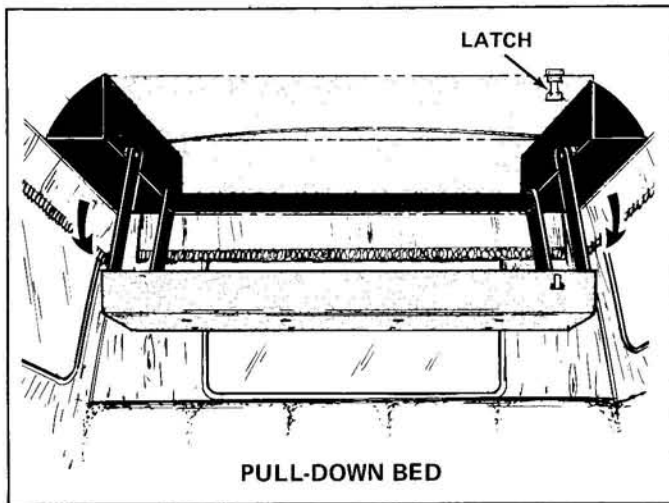

NOTE: Optional sofas, available on all models to replace the 3-way dinette, also can be converted into beds.

DIVIDER DRAPES — Divider drapes to separate the driving and living areas are standard in all models. The drapes slide on ceiling tracks and can be pulled together to close off the driver area. When open, the drapes can be attached at either side of the unit with tiebacks. A center privacy drape is an available option on 26' RB models.

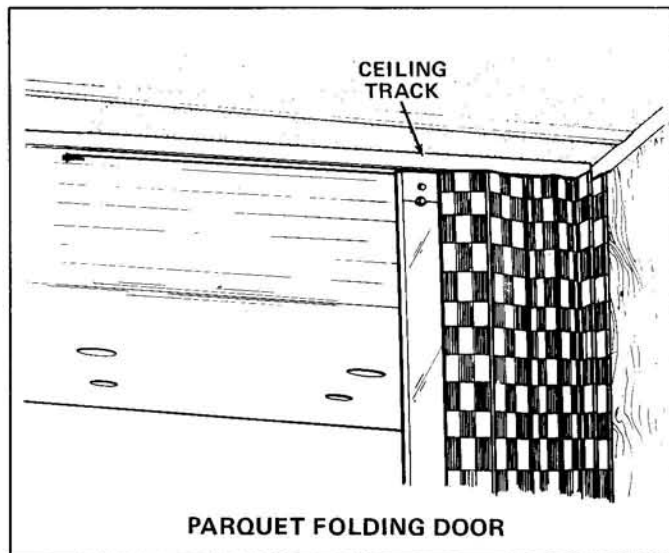

CARE OF CUSHION FABRICS — Use a mild soap and water solution to clean cushion covers.

CARE OF DRAPES, CURTAINS — The drapes in your motor home should be dry cleaned only.

CARE OF SHADES — Use a mild soap and water solution to clean the shades. The wood-woven shades in some models should be vacuumed only.

CARE OF CARPET — Vacuum the carpet as needed and use any household type carpet cleaner.

CARE OF WOODWORK — Clean the woodwork with regular household furniture polish. **DO NOT** use water to clean wooden surfaces. Scuffs may be covered with furniture wax and stain mixture. Scratches may be covered with Almond Stick.

BASIC SYSTEMS

GENERAL

The basic utility systems in your Jimmy motor home can be classified under four titles — Electrical, LP Gas, Fresh Water and Drainage/Sewer. This section outlines these systems, describing their operation, function and simple maintenance. It is not intended as a service guide. Your motor home has been engineered and built to provide trouble-free operation, but should a problem arise, we recommend that you contact your authorized GMC dealer.

A monitoring panel allows you to check the condition of most systems conveniently from the interior of your motor home. It has indicators to show the volume of fresh water, LP gas, waste and gray water in your holding tanks, and the condition of your RV battery. The monitoring panel also contains the water pump switch; the generator remote START/STOP switch, and the generator hours-of-operation meter.

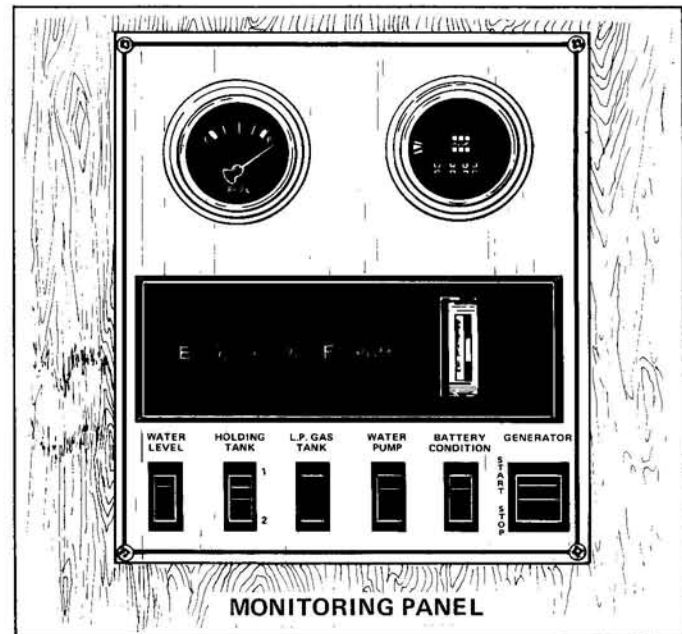

ELECTRICAL

GENERAL

Your motor home has two separate electrical systems, providing you with power while you are camped or traveling. There is a 12-volt direct current system, such as those in automobiles, and a 120-volt alternating current system, which requires an external source of 120-volt electricity, provided by a connection to a campsite or household receptacle or by an optional generator. The 120-volt system should be

used whenever a 120-volt hookup is available to reduce the load on your 12-volt battery. The 12-volt system is supplied by batteries and is used when you are on the road or in campsites which do not provide 120-volt hookups. Because most components in your motor home, such as the water pump, range hood light and fan, interior lights and interior 12-volt receptacles, operate only on a 12-volt source, your vehicle is equipped with a power converter which changes 120-volt AC to 12-volt DC power.

120-VOLT SYSTEM

The 120-volt system supplies electricity for optional roof air conditioners, the refrigerator, power converter for the 12-volt system, the exterior 120-volt receptacles (Figure 1), and the 120-volt receptacles located throughout your motor home, which are used to operate regular household appliances. Whether you use the external 120-volt Shoreline connection or an auxiliary generator, the power source is connected directly into the main electrical service panel and is distributed through circuit breakers.

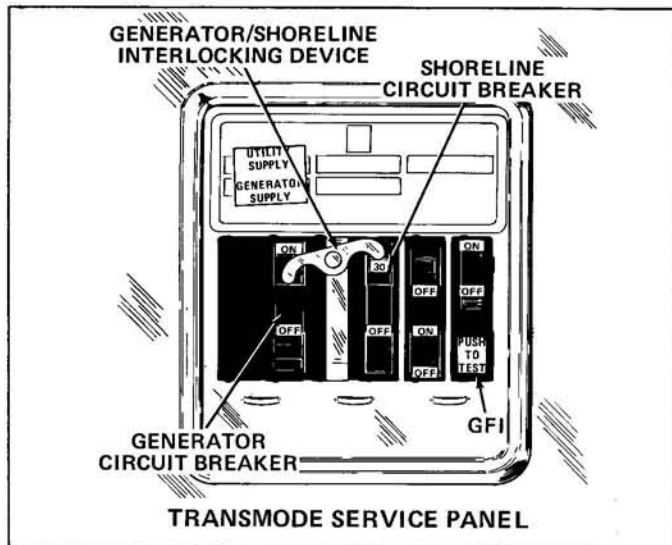

GROUND FAULT INTERRUPTER — The bath and exterior receptacles are connected to a Ground Fault Interrupter (GFI). This highly-sensitive circuit breaker will help protect against severe electrical shock if a ground fault develops. If this occurs, the GFI will break the circuit by turning the power off to those receptacles. Should this happen, unplug all appliances on that circuit and reset the breaker.

CAUTION: *The GFI does not completely eliminate electrical shock. Small children and persons with heart conditions or other disabilities that make them especially sensitive to electrical shock may still be injured by a ground fault on the bath or exterior receptacles.*

Test the GFI system at least once a month, preferably before each trip. Depress the PUSH TO TEST button. The button will pop out if the circuit breaker is operating properly. Power will be off at bath and exterior receptacles. Plug a test light

into these outlets to verify power is off. To restore power, push in the button.

NOTE: *If the button does not pop out or the test light indicates a live circuit, DO NOT use the outlets. Call your GMC dealer.*

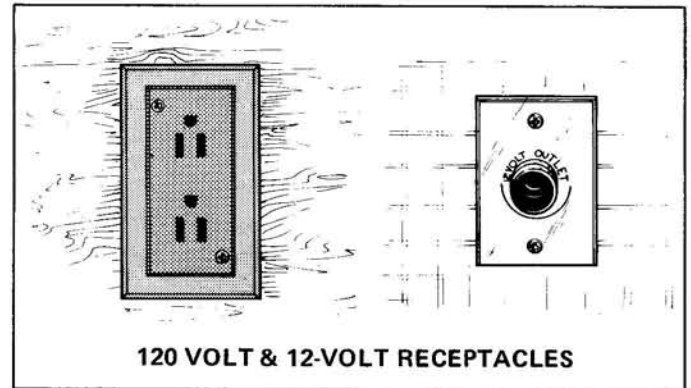

SHORELINE CONNECTION — The Shoreline (Figure 2) is a 25', 30-amp power cord with a 3-prong grounding plug on one end, permanently attached at the other end to the service panel. It can be pulled from its storage compartment through a hatch in the sidewall of your vehicle and connected to an external 120-volt receptacle. Some campsites and trailer parks still have two-slot receptacles. If it is necessary to use a three-to-two adapter, be certain its grounding wire is fastened securely to the outlet grounding screw. If in doubt, you may attach a No. 6-AWG copper wire to the frame of the vehicle and fasten it to an 8-inch copper or brass stake driven into the ground.

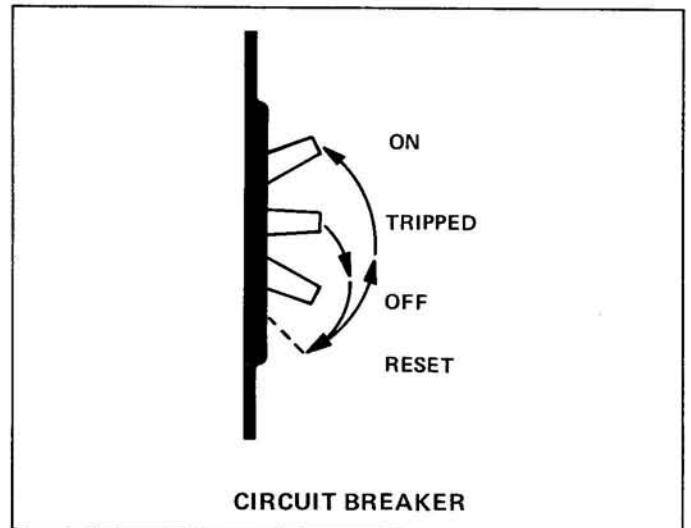

The 120-volt system is protected by the circuit breakers. If a circuit breaker opens, unplug the appliances on that circuit, allow a short period for the breaker to cool, then reset the breaker. If the breaker continues to open, contact your GMC dealer.

12-VOLT SYSTEM

The 12-volt system, which includes the automotive and RV batteries (Figures 3 and 4), plus the 12-

could draw fumes into your unit. **DO NOT** operate the generator where an object, such as a tree, bush or building, may deflect exhaust fumes inside your unit. **DO NOT** operate the generator inside a building unless the exhaust is vented safely outside. **DO NOT** operate the generator where exhaust gas could accumulate and seep back inside an occupied vehicle, tent or building.

FRESH WATER SYSTEM

GENERAL

Fresh water for your unit is supplied either by the vehicle's fresh water tank or an external pressurized source. Both supply water to the kitchen sink, tub/shower, lavatory, toilet and water heater.

WATER TANK

Unlock the door to expose the gravity water fill (Figure 6). Use a hose or vessel to fill the water tank. Water will flow out the fill opening when the tank is full.

WATER PUMP

Your water pump is a 12-volt DC appliance, activated by a switch on the Monitoring Panel. You may leave the switch ON while camping. This arrangement is known as a demand system. When you want water, simply open a faucet; the pump will run only as long as needed. If the pump fails to start when the switch is ON, check the fuse located in the fuse panel. If the pump continues to operate, whether the faucets are opened or closed, check the water tank, it is probably empty.

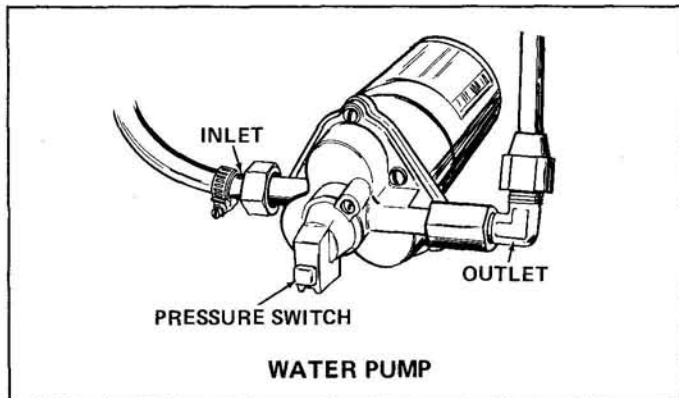

SANITIZING WATER TANK

Sanitize your unit's water tank before initial use, after a period of nonuse, and whenever the tank is suspected of being contaminated. Open the water tank drain valve. When the tank is empty, close the valve. Mix 3 gallons of water with 3/4 cup liquid household bleach. Pour the solution into the tank through the gravity fill. Wait 3 hours, drain and flush with fresh, potable water. If chlorine taste lingers, pour 1 quart of vinegar and 5 gallons of water into the tank. Wait several days before draining water. Flush tank with fresh, potable water.

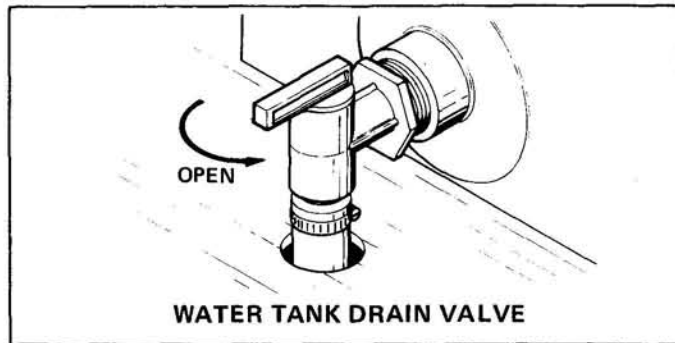

CITY WATER

Connect a hose to a "city" pressurized water faucet and to the vehicle's water inlet (Figure 7). When using the city water hookup, the water tank and pump are bypassed. You cannot fill the water tank through the city water inlet.

Although a common garden hose can be used to fill water tanks and to connect to city water, longtime RV'ers recommend a hose specifically manufactured for this purpose.

CAUTION: In areas where city water pressure exceeds 60 psi, you should use a pressure regulator. Excessive water pressure may damage lines and connections. See your GMC dealer for further details.

WATER PURIFIER

The optional water purifier is designed to provide clear, good-tasting, bacteria-free drinking water. It is connected to the cold water line below the sink and attached to a special faucet on the sink ledge. Push down on the lever for a restricted flow of water or lift the lever for an unrestricted, continuous flow. See the manufacturer's instruction booklet for backflushing the purifier element and maintenance.

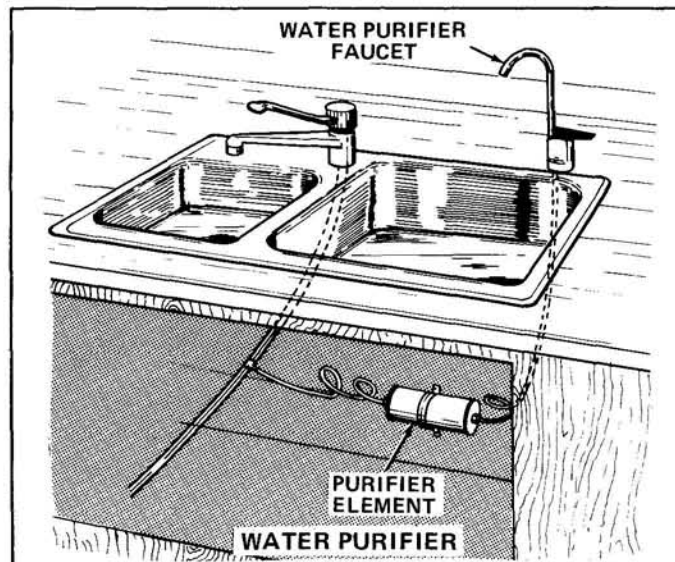

CARE OF SINKS, LAVATORY & TUB/SHOWER

Clean the kitchen sink, lavatory, tub and shower-

pan with non-abrasive cleaner. Stainless steel cleaner may be purchased at most grocery stores. ABS cleaner, such as Aqua K-7, may be purchased from your GMC dealer.

LEAKS

Traveling over bumpy or rough roads can cause pipe fittings to loosen; check pipe fittings regularly for signs of leakage.

DRAINAGE/SEWER SYSTEM

GENERAL

Your motor home will have a Drainage/Sewer system which functions much the same as the one in your home. It includes drain lines from the kitchen sinks, lavatory, and tub/shower to the gray water holding tank and a marine-type toilet which empties directly into a separate waste holding tank. The drainage system also includes vents which carry odors (caused by drain water and waste) out through the roof, while equalizing air pressure. The latter is necessary to maintain a water barrier against odors in the "P" traps and to ensure smooth flow and escape for your drainage system.

DRAIN CARE

Use clear water to clean exterior pipe surfaces. DO NOT use harsh drain cleaner chemicals or solvents in drains. Drain cleanouts are installed at intervals to facilitate drain line cleaning or unclogging. Use a wrench to remove and replace drain cleanout plug.

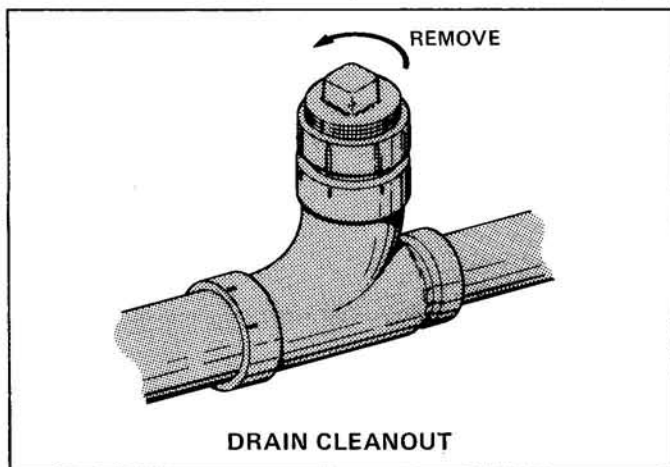

TOILET

Jimmy installs either a Galaxy or Starlite model Aqua Magic marine toilet. Each model has two pedals near the front base for flushing and adding water. To operate the toilet, step on the small pedal to add water to the bowl. When the desired amount has entered, release the pedal slowly. To flush, step on the large pedal until water swirls, then release pedal slowly. Before initial use and after emptying the holding tank, flush the toilet. When the bowl is filled, pour in 8 ounces of Aqua-Kem concentrate,

then flush the toilet again. This will help to control odors.

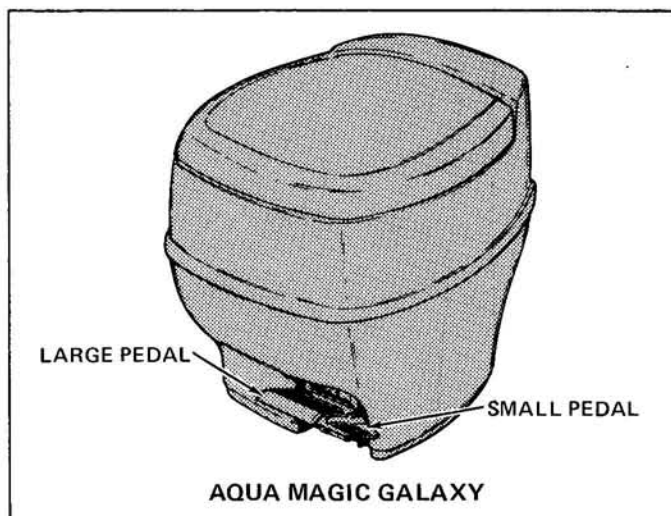

CARE OF TOILET — Use Aqua Bowl Cleaner as directed. DO NOT use highly-concentrated or high-acid household cleaners (NO SCOURING POWDER) to clean the bowl. If the slide valve does not move freely, apply silicone spray.

HOLDING TANKS

A gray water holding tank is for kitchen sink, tub/shower and lavatory water; a waste holding tank is for the marine toilet. Each should be emptied frequently, always in a specified dumping station. Most campgrounds are equipped with dumping stations, often at each campsite; many service stations also have waste dumping stations. Avoid having to empty tanks too often by using restroom facilities when available. You can prevent unnecessary accumulation of solids in the waste holding tank by not putting facial tissues or similar items into the toilet.

EMPTYING HOLDING TANKS — Be certain your vehicle is level since emptying of holding tanks depends on gravity. Remove the sewage drain hose from its storage container (Figure 8). Remove the cap from the termination outlet (Figure 9) and connect the sewage drain hose. If you leave the drain hose connected to the termination outlet when you are camped, DO NOT open the termination valve until you want to empty the holding tank. The system is not like your plumbing at home where waste is flushed directly into the sewer system. Instead, if the valve is left open only liquid waste may drain out, causing solids to collect and harden in the bottom of the holding tank.

To drain either holding tank, pull out the dump valve slide handle (Figure 9). You can empty the left-hand holding tank by opening only the dump valve handle on the left. To empty the right-hand holding tank, both dump valve handles must be open. Flush or pour about two gallons of water through the toilet when emptying the waste holding tank and drain again. This flushes the tank and helps clean the drain hose. Repeat as necessary.

Follow the same procedure for a gray water holding tank, although a repeat flushing may not be necessary. When the tanks are empty, push in the dump valve handles until they seat. Remove the hose, wash it and return it to the storage container. Replace termination outlet cap.

LP GAS SYSTEM

GENERAL

The Liquefied Petroleum (LP) Gas System in your unit furnishes fuel for hot water, heat, cooking, and refrigeration. LP gas, a by-product of the petroleum refining process, provides a portable, efficient and inexpensive source of energy. It is stored in a tank (Figure 10) in a compartment of your unit. Under pressure in the tank, the LP gas turns to vapor; it is the vapor which burns. Each tank has a 20% liquid level gauge which allows space in the bottle for vapor expansion. The high pressure of the vapor in the bottle is reduced in two stages through a regulator. The tank pressure will vary with temperature and altitude, but may be 100 to 250 pounds per square inch or more. It is reduced to about 12 psi in the first stage, then to about 6-1/4 ounces in the second stage (the 6-1/4 ounces per square inch also is expressed as 11 inches of water column). The LP gas is propane or a blend of propane and butane, depending upon your locale.

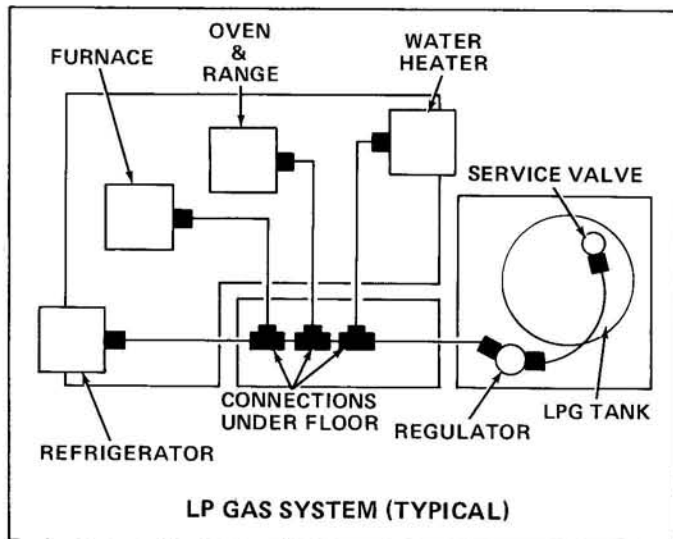

The LP gas system is designed and built to rigid standards and tested before leaving the factory. Your GMC dealer also tests the system prior to delivery to you. Except for simple maintenance and occasionally tightening a connection, you should take your unit to an authorized GMC dealer for LP gas problems. The LP tank should always be filled by an authorized LP supplier.

NOTE: Jimmy Motor Homes is not responsible for personal injury or property damage resulting from improperly maintained LP gas appliances and systems.

LP gas burns readily and with intense heat. *With*

proper care and maintenance, it is safe and efficient. However, there are certain characteristics of LP gas of which you should be aware. In its natural state, LP gas is odorless, but an additive gives it a distinctive odor so that leaks may be readily detected.

WARNING: For your safety, if you smell gas:

1. Open all windows
2. DO NOT touch electrical switches
3. Extinguish any open flame
4. Close Service valve
5. Immediately call your gas supplier

LP gas is heavier than air and tends to collect in low pockets. As LP gas settles into any closed area, it displaces air and thus could cause suffocation if not detected. It could also create a fire or explosion hazard.

Before using any LP gas appliance, read the respective manufacturer's instruction manual.

CLIMATE DIFFERENCES

The appliances will not function if the LP gas does not vaporize. Butane will not vaporize below 32 degrees F. (the freezing point of water), but propane will continue to vaporize down to 44 degrees below zero. Propane has become the main type of LP gas used in RV's in recent years. Your LP supplier will have the correct type or blend for your locale. If your travels will take you into an area where climate differs, ask your LP dealer for his recommendations. The names of LP suppliers can be found in the yellow pages of your telephone directory under "Gas-Liquefied Petroleum - Bottled & Bulk". Many campgrounds now have LP gas fill facilities, as do some service stations.

To operate any LP gas appliance, the LP gas tank's Service valve (Figure 10) must be OPEN. When first used, or after a refill, there may be some air in the gas lines which will escape when you first open a range burner or similar LP gas valve. The air may extinguish your match or igniter the first time or two, before you get ignition. Remember, too, that when you close the tank's Service valve some of the gas will remain in the lines. To completely bleed the lines of gas, CLOSE the tank's Service valve and light a range burner to use up the excess. When the flame burns out, turn the range burner OFF.

FILLING THE LP GAS TANK

Before having an LP gas tank filled, be certain all burners and pilot lights are off.

Drive your motor home to an authorized LP supplier for filling (never remove the tank). He will connect the fill nozzle to the LP gas tank fill valve. The Service valve and the 20% liquid level gauge must be open. When liquid appears at the liquid level gauge, the tank is filled to its LP capacity. Close the Service valve and the 20% liquid level gauge. Do not use a wrench to tighten the Service valve or the 20% gauge; they are designed to be closed

leak-tight by hand. If you cannot hand-tighten properly, the valve probably needs repair or replacement.

Because there may be some leakage of LP gas when the tank is being filled, we recommend that you drive at least a mile away from the LP gas dealer's before you relight any pilot lights or appliances. DO NOT relight pilots or appliances if the scent of LP gas is present. Open the windows and doors and wait 30 minutes. If the odor is still present, follow the instructions in the LP GAS LINE CHECK section.

CAUTION: Avoid overfilling by insisting that the LP gas bottle never be filled beyond the 20% liquid level. If the bottle is overfilled, have the LP gas dealer bleed out the excess. Overfilling does not allow sufficient space for the liquid to expand. This can produce excessive pressure which can cause LP gas leaks, creating a potential fire or explosion hazard. DO NOT smoke, strike a match or ignite a lighter when the LP gas bottle is being filled. A spark or flame could ignite fumes. Be certain all burner and pilot flames are out and the Service valve is closed when filling your motor home's gasoline tanks.

LP GAS LINE CHECK

Check the gas line connection at least after each third re-fill and inspect other connections regularly, at least every 30 days or 5,000 miles of travel. To check, turn off all burners and pilot lights. Open all doors and windows. Open the LP gas bottle Service valve and use soapy water, a bubble solution or approved leak detector to test all line connections. Do not use products that contain ammonia or chlorine. Bubbles indicate a leak. Tighten the connections with two open end wrenches until bubbles stop. If leak persists, contact your GMC dealer.

REGULATOR PRESSURE

Check the LP gas regulator at the beginning of each season, or whenever a problem is indicated. Correct line pressure is 11 inches of water column. Your GMC dealer or LP gas supplier can perform this check.

LP GAS TANK CARE

After each trip, inspect the LP gas tank. Sand off traces of rust and apply a rust preventative paint. Always use a light color paint, which reflects heat. When the LP gas system is not in use, the Service valve should be closed.

APPLIANCES AND ACCESSORIES

RANGE, RANGE HOOD, OVEN

GENERAL — Your Jimmy motor home will have a four-burner range and oven and a recessed power range hood. The range burners and oven are

LP gas appliances. You should read the manufacturer's manual for complete details on the operation and care of the range, range hood and oven.

LIGHTING THE RANGE — Be certain the LP gas Service valve is OPEN. Light a match and hold it close to the range burner, then turn the burner's control knob to full ON. Air in the line may cause a blowing noise and may extinguish the match. When the line is free of air, the burner will light readily. Adjust the burner flame with the control knob.

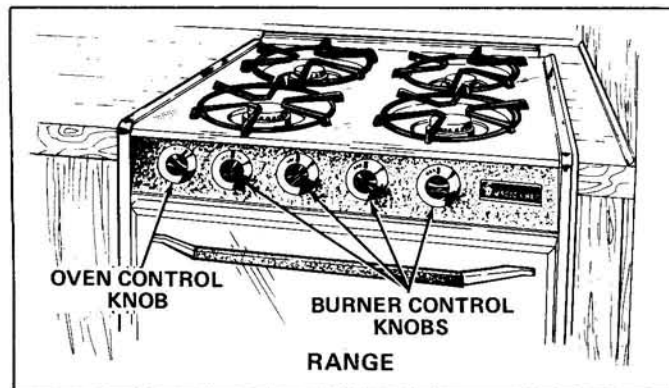

LIGHTING THE OVEN — Be certain the LP gas Service valve is OPEN. Depress and turn the oven control knob counterclockwise from PILOTS OFF to OFF. Open the oven door and hold a lighted match next to the constant pilot area. It is near the rear of the oven compartment, just below the main oven burner. Relight the pilot if the air in the line extinguishes the flame. When the pilot remains lit, adjust the oven control knob to the desired temperature setting.

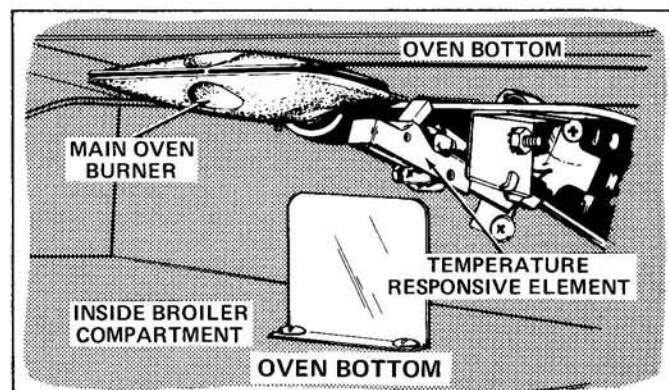

CAUTION: When using the range burners or oven, open a window or vent. DO NOT use range and/or oven to heat the interior of your unit. Failure to heed these cautions could result in asphyxiation.

BROILER — Your oven is equipped with a broiler. To use it, light the oven and set the control knob to "B". Place the broiler pan in the area below the oven burner. Do not place meat too close to the flame, because the fat may ignite. Use foil only as recommended: Never cover the holes in the broiler pan or the air openings in the oven bottom with foil. Always remove the broiler pan as soon as you have finished broiling. If the pan is not removed and the oven is used, the grease may bake onto the surfaces or it may ignite.

RANGE HOOD — Your unit will have a 12-volt power range hood. The power range hood has a fan and a light, each controlled by a switch on the bottom of the hood. Turn fan ON to draw smoke and cooking fumes out of the unit.

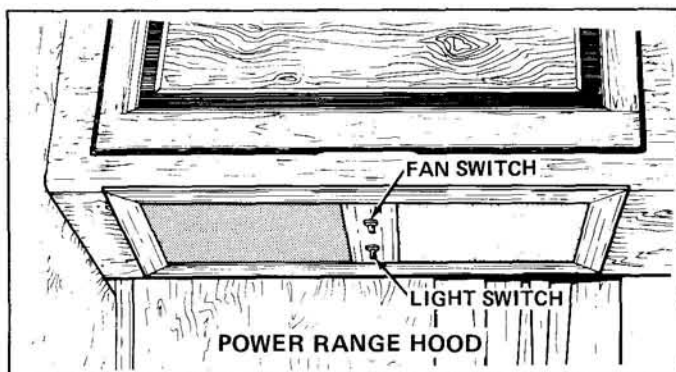

CARE OF RANGE AND OVEN — Allow the range top to cool, then clean it with hot, soapy water. Use a damp cloth to clean chrome surfaces. Grease splatters, which may bake onto the surfaces, should be wiped off before they have time to harden. Use chrome polish to remove stubborn stains. Use a toothpick to clean clogged burner orifices. DO NOT use metal objects, such as an ice pick or wire to unclog burners. They may distort the opening and adversely affect burner operation.

Clean the oven with commercial cleaner after each trip, or as necessary. DO NOT apply cleaner to aluminum gas tubing, thermostat sensing bulb or electrical components.

CARE OF RANGE HOOD — For metal surfaces, use the same procedure as for the range top. Clean the plastic light cover by removing and washing it. To clean the filter, push slot located in center front of screen and pull down. If not greasy, simply tap the filter to shake out the dirt. If the filter is greasy, run hot, soapy water over it until grease dissolves. Allow the filter to drain and dry then replace by positioning the flanges and push into place. Clean fan and motor surfaces frequently to remove grease.

MICROWAVE OVEN — The optional microwave oven is a 120-volt appliance used to cook, defrost

or simmer foods in less time than other cooking methods. The control panel has a timing device, a defrost switch and a menu guide. When the door is opened, the interior light will automatically switch on.

To cook, the defrost/5 switch must be OFF unless otherwise recommended. Turn the timer to the recommended time (if you are cooking for less than one minute, turn the timer past one and then back down). Close the door to begin cooking. The blower will start and warm air will be exhausted through the top of the oven. If you open the door while cooking, the blower and timer will shut off. When you close the door, both will resume. When the cooking time is reached, the oven blower and light will turn off.

To defrost, push the defrost/5 switch ON. Set the timer according to recommendations. Put the frozen food inside and close the door.

To simmer, the defrost/5 switch must be ON. Follow the instructions listed in your cookbook.

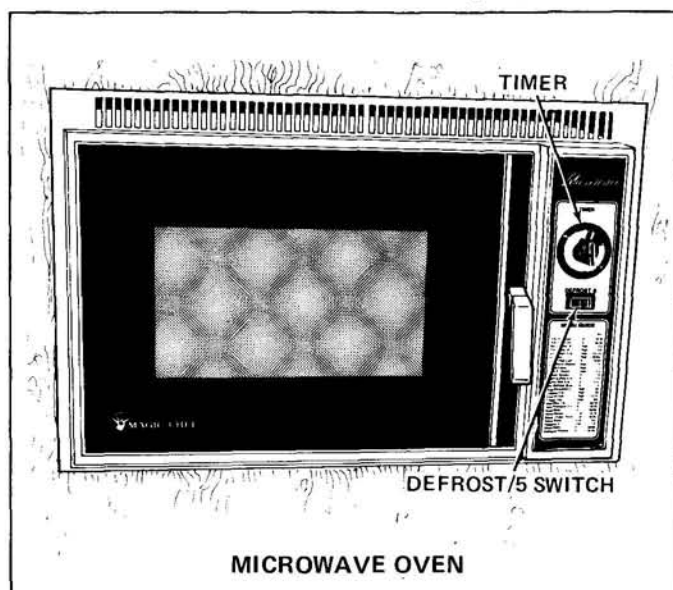

CAUTION: Popping corn is not recommended as a use of the oven. Any excessive overcooking of food may cause the food to ignite. Be sure the timer is set at zero when the oven is not in use.

CARE OF MICROWAVE OVEN — Clean the outside and inside with a soft cloth, mild detergent and warm water. Thoroughly wipe the top, sides, shelf and back walls of the inside. Rinse well. Wipe spills off the inside every time you use the oven. To replace oven bulb, unplug the oven. Loosen the screw on the rear access panel and open. Use a 25-watt "bayonet base" bulb. Fasten the rear panel and plug the oven in.

WATER HEATER

GENERAL — The water heater (Figure 11) is an LP gas appliance capable of heating 6 gallons of water to a pre-set temperature. It will fill automa-

tically either from the fresh water tank or when the system is connected to a "city" water faucet. When filling the fresh water tank, open a hot water faucet briefly — with the pump switch ON — to allow the water heater to fill.

The ignition switch for the water heater is under the sink on the inside of the cabinet frame. To light, press the lower portion of the switch. A light will come on if there has been no ignition. Press the upper portion of the switch and wait 30 seconds, then press the lower portion again.

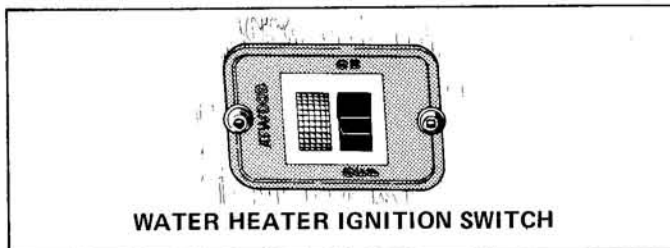

WATER HEATER IGNITION SWITCH

NOTE: If after attempting to ignite the water heater 5 times, the non-ignition light continues to come on, contact your GMC dealer.

BURNER ADJUSTMENT — Loosen the set screw which holds the air shutter in place. Slide the main burner air shutter to the right until the flame has a yellow tip. Slowly slide the shutter to the left until the yellow tip disappears. Tighten set screw.

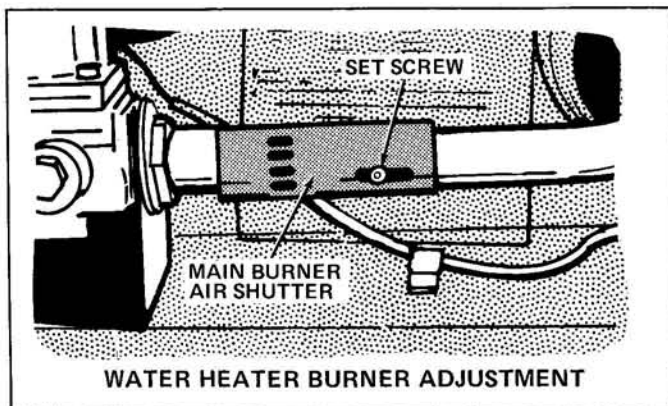

WATER HEATER BURNER ADJUSTMENT

DRAINING — Open the drain cock. When the water heater tank is empty, close the drain cock.

REFRIGERATOR

GENERAL — When you park your vehicle, even for a relatively short period, the refrigerator must be level since it functions on the gravity flow of chemicals. (If you must stop on an uneven site, turn the refrigerator control to zero.) Use a level on the freezer compartment floor to check levelness. Whenever possible, park the vehicle so the refrigerator side will be opposite the sun. Your refrigerator is powered by LP gas, 120-volt or 12-volt electricity. The control panel is located inside the refrigerator door. Before starting on a trip, use the Shoreline connection to cool the refrigerator the night before.

Keep items to be stored in your RV refrigerator in your home refrigerator or freezer until you are ready to leave. This will reduce the cooling load on your RV refrigerator and help keep perishable foods fresh longer. Always store food in sealable containers or suitable wrapping. When traveling, switch to 12-volt electrical operation. Use door latch during travel.

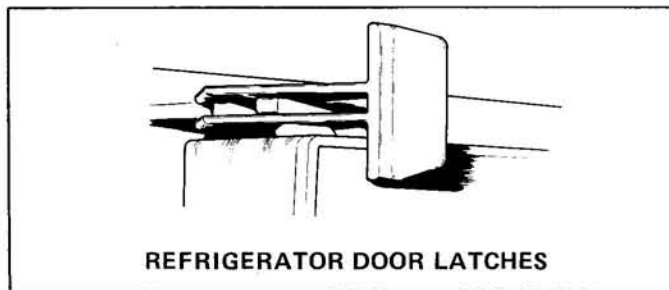

REFRIGERATOR DOOR LATCHES

LP GAS OPERATION — Pull the OFF/12V/ELEC/GAS selector outward and turn it counter-clockwise to GAS. Pull the valve button out while pushing lighter button in. Repeat this until ignition is observed through the reflector. Turn the gas thermostat to the highest number on the dial. Later adjust temperature to meet your cooling requirements.

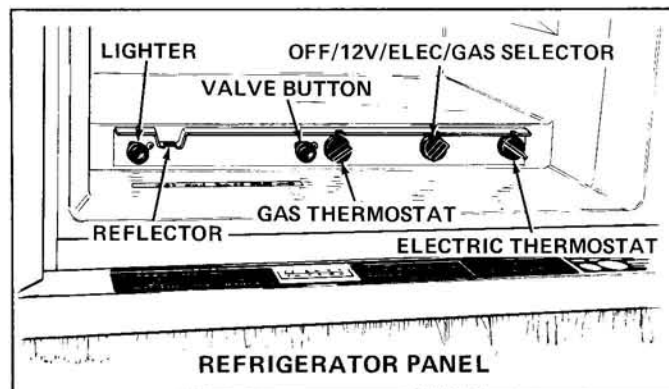

REFRIGERATOR PANEL

ELECTRIC OPERATION — The refrigerator operates on 12-volt or 120-volt electricity. The refrigerator is the only 12-volt appliance which does not draw power from the converter. Even with the Shoreline connected the refrigerator's only source of 12-volt power is the auxiliary battery. When parked at a campsite, switch to LP gas or to 120-volt electricity to conserve your battery. Make certain the refrigerator power cord, reached through the exterior access door, is plugged into the 120-volt receptacle, located in the outside compartment. Be sure the breaker is ON.

Rotate the OFF/12V/ELEC/GAS selector to the source of power you want, either 12V or ELEC (120-volt). Turn the electric thermostat to the highest number on the dial. Later adjust temperature to meet your cooling requirements.

CARE OF REFRIGERATOR — Remove food and ice after each trip. Clean interior with warm water and liquid dishsoap. Wipe dry with soft, dry cloth. DO NOT use abrasive cleaning material; it

will scratch interior surfaces. Prop the door open during periods of nonuse.

To defrost refrigerator freezer, remove frozen food and ice. Turn off the thermostat. Place a pan of hot water inside the compartment to speed up the defrosting process. Dry the interior with a clean cloth.

FURNACE

Your motor home is heated through a duct system by an LP gas furnace. The furnace is controlled by a thermostat.



NOTE: It is important to remember that although the furnace's heat source is LP gas, the blower operates on 12-volt electricity. DO NOT operate the furnace for prolonged periods without a 12-volt power source. You could run down your RV battery.

FURNACE IGNITION — When lighting the furnace, you must be certain the LP gas tank's Service valve is OPEN and the furnace LP gas valve is completely open.

Set your wall thermostat to the desired temperature. If the furnace does not light within 15 seconds, return the thermostat to OFF and wait 2 minutes. The furnace should light after repeating the procedure two or three times.

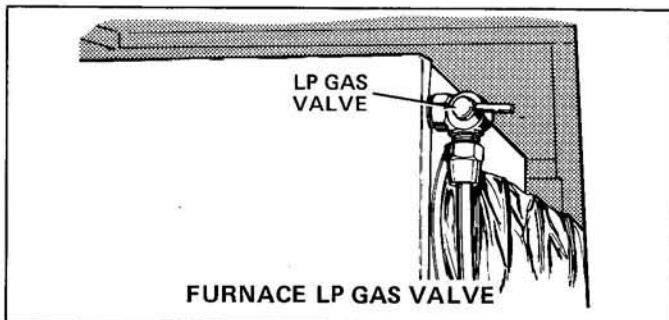

NOTE: If the furnace does not light after the third attempt, turn the thermostat OFF or close the furnace LP gas valve and contact your GMC dealer. DO NOT attempt to repair or adjust the furnace yourself.

CARE OF FURNACE — The furnace requires only routine cleaning. Soot, which may form on

the inside of the combustion chamber, may be removed with a vacuum sweeper. Check the furnace Inlet/Exhaust Cover (Figure 12) on the outside of the unit periodically to be certain it is free of objects which might block the openings.

NOTE: Portable fuel-burning heating appliances should not be used for comfort heating in the living area of your Jimmy unit.

VACUUM SWEEPER

The vacuum sweeper is a 120-volt appliance. To use, lift the inlet lid and connect the hose. The system automatically activates when the lid is lifted, and turns off when the lid is closed.

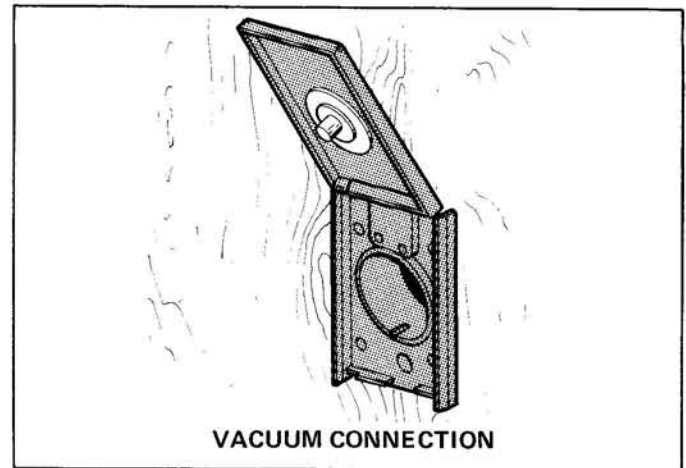

FOOD CENTER BLENDER

The optional food center blender operates on 120-volt electricity. It consists of a power unit, six-speed control and blender.

Place the blender into the blender receptacle. Turn clockwise to lock into place. Place food into the blender. NEVER operate the blender unless the lid is firmly in place. Turn the control dial to the desired speed.

Your food center can also mix, shred, grind or slice food with additional attachments which are available from a Nutone food center dealer.

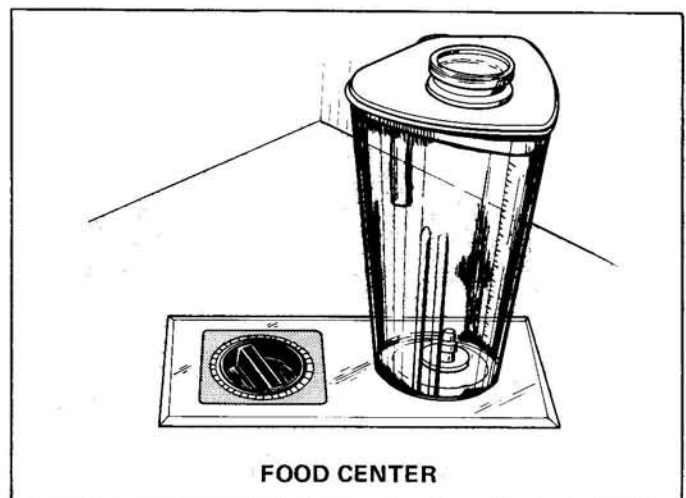

ROOF AIR CONDITIONER

GENERAL — If you did not order the optional roof air conditioner at the time of purchase, your unit is wired so that one can be added. Just order it from your GMC dealer. The roof air conditioner will operate **ONLY** on 120-volt electricity.

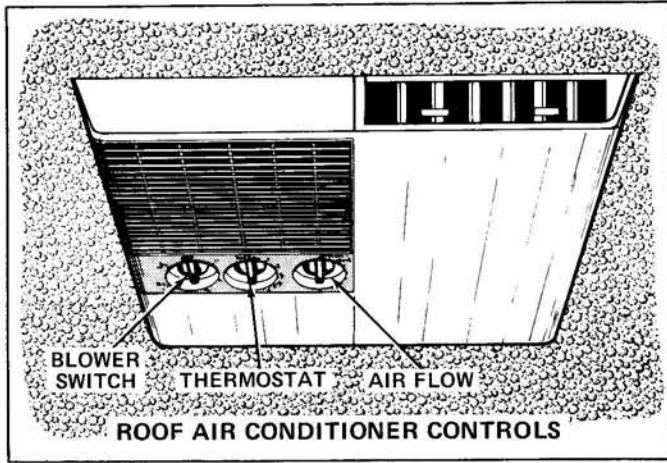

CONTROLS — The roof air conditioner is controlled by a panel on the portion of the appliance which is attached to the ceiling inside your unit. The panel consists of controls for cooling air recirculation, air flow and distribution.

To cool, set the blower switch to the desired fan speed and turn the temperature control dial to the desired temperature.

To recirculate the air, set the blower switch to the desired speed.

The air flow may be adjusted by moving the air flow control to **FRONT** or **REAR**. Adjust the louvers on each side of the air conditioner to obtain the desired amount of air circulation.

CARE OF AIR CONDITIONER — Remove and clean the filter at least once every two weeks if it is used extensively. Wash filter in soap and warm water. Let filter dry before installing. **DO NOT** operate the air conditioner for extended periods without a filter.

AM/FM/MPX STEREO RADIO AND 8-TRACK TAPE PLAYER

The tape player is equipped with an automatic head cleaner. Occasionally you will have to clean oxide off the tape playback gear, capstan shaft and the automatic track selector. To activate the capstan, depress the switch (located next to the capstan) with the eraser end of a pencil. Use a cotton swab, moistened with isopropyl alcohol to clean the playback head, capstan shaft and the automatic track selector.

CAUTION: *DO NOT* use carbon tetrachloride to clean components of the tape player.

TV ANTENNA

If you plan to use a television set in your Jimmy

unit, an optional antenna will improve your reception. A coaxial connection for the antenna cable from your TV set, and a switch which turns on the amplifying system, are mounted on a wall plate. A light indicates when the power outlet switch is on. The plate also has a 12-volt receptacle for TV sets especially designed for that type of energy.

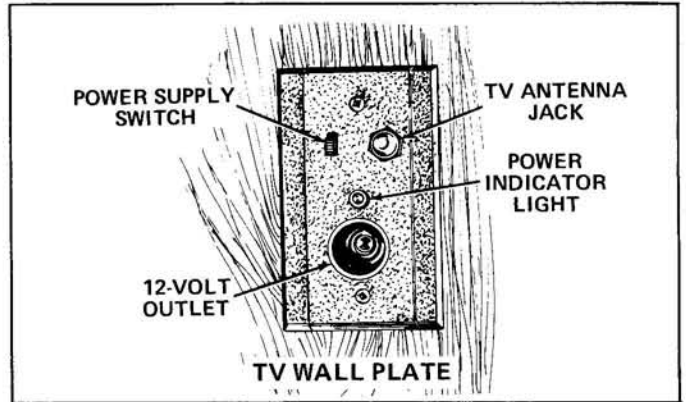

Simply turn the antenna crank handle in the **UP** direction until some resistance is felt. Pull down the rotating knob to disengage it from the ceiling plate and turn it until you find the best sound and signal.

Always lower the antenna before moving your unit. Turn the rotating knob so that its pointer lines up with the ceiling plate pointer. Turn crank handle in **DOWN** direction until some resistance is felt. Turn off the power switch.

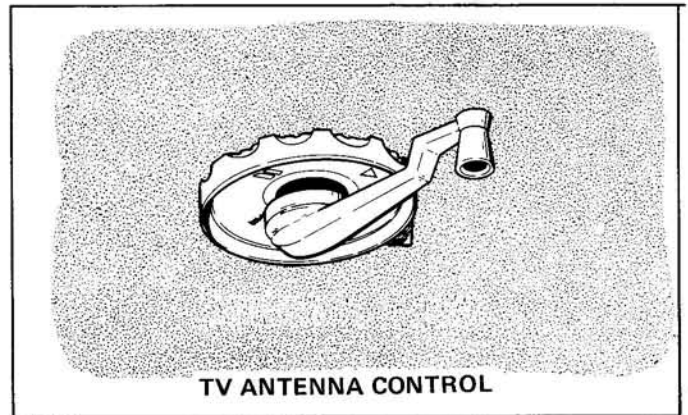

DIGITAL CLOCK

A dashboard-mounted digital clock is optional on all models. To set the clock, obtain the correct time from an accurate source, such as a telephone time service, and use a watch with a sweep second hand to record the exact time of the tone. Insert a ballpoint pen or similar object into the left hole on the front of the clock to adjust the hour indicator. Remove the pen when the correct hour appears. Insert the pen into the right hole to adjust the minute indicator, removing the pen when the preceding minute appears. Set the correct time by re-inserting the pen into the right hole as the second hand of the watch reaches the exact time of the tone.

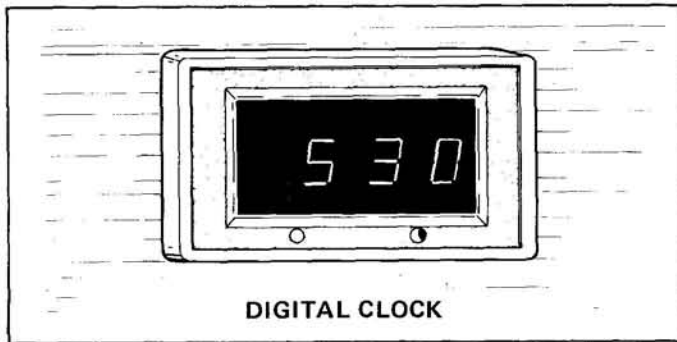

DIGITAL CLOCK

MAINTENANCE

GENERAL

Recreational vehicle owners are noted for the pride they take in the appearance of their units. Proper maintenance will do more than keep your Jimmy motor home looking nice, however. It can help ensure trouble-free operation and maximum efficiency of the various appliances and components. Failure to properly maintain the vehicle or its components also may constitute a breach in your warranty obligations. See the various manufacturer's manuals for specific maintenance instructions.

EXTERIOR

The acrylic finish on your motor home should be washed frequently with lukewarm or cold water. DO NOT use hot water or wash in the direct rays of the sun. DO NOT use strong soap or chemical detergents. All cleaning agents should be promptly flushed from the surface and not allowed to dry on the finish. Use a cleaner which has been approved for acrylic finishes to remove oil, road tar, tree sap, bird droppings, or other foreign materials from your motor home.

Your GMC dealer can furnish several polishes and cleaners which you can use to help maintain the original finish appearance and durability.

Bright metal parts usually need only washing with water to maintain luster. However, chrome polish may be used on chrome or stainless steel. Never use auto or chrome polish on aluminum trim. A coating of wax is recommended for all bright metal parts.

UNDERBODY

Corrosive materials used for ice and snow removal and dust control should not be allowed to accumulate under the body. These materials can result in rusting and deterioration of underbody components. At least once each year, preferably after a winter's exposure, these corrosive materials should be removed by flushing the underbody with plain water.

AUTOMOTIVE SYSTEM

See the Chassis and Body Operating Manual for details on service and maintenance of the motor home's automotive system. The engine cover can

be removed by pulling back the carpet near the cover's base, lifting the bolt rings and removing the two bolts. To replace the cover, insert front edge into the retaining lip. Place board on frame and fasten both retaining bolts.

CAUTION: The interior engine access cover must be properly sealed to prevent engine exhaust from entering the vehicle. Make certain that carpeting or other materials do not interfere with the installation of the access cover.

STORAGE

GENERAL

You should perform the following procedures if you will not be using your unit for an extended period.

LP GAS SYSTEM

Close the LP gas Service valve. Extinguish all pilots and close all LP gas valves. Light a range burner to consume any gas remaining in the lines. When the flame burns out, turn the range burner OFF.

WATER TANK

Turn ON water pump. Open all water faucets. Open the water tank drain valve and the hot and cold water line drain valves. Water line drain valves are inside, near the water tank. Drain the water heater. When the tank is empty, close all faucets and drain valves.

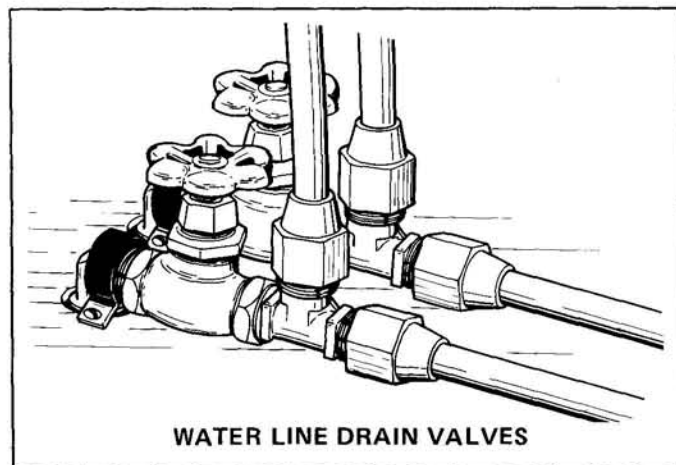

WATER LINE DRAIN VALVES

WATER PUMP

When the water tank is empty, run the water pump with the intake and the outlet hoses disconnected for about 1 minute or until all water is expelled. If possible, connect an air hose to one of the hose connections and blow air through the pipes to clear them of water. Re-connect hoses.

FURNACE

To shutdown the furnace for storage, turn OFF the LP gas valve and the thermostat.

ELECTRICAL SYSTEM

Turn off all circuit breakers at the service box.

EXTERIOR

Store your unit in a garage or other shelter, if possible, or cover with a tarpaulin or plastic.

INTERIOR

Close and secure all doors and windows. Open a roof vent or window slightly to allow circulation, but be certain interior damage does not occur during inclement weather.

WINTERIZATION

GENERAL

You should winterize the fresh water system, drains and toilet before storing your unit.

FRESH WATER SYSTEM

Pour 6 gallons of non-toxic, plastic pipe anti-freeze into the gravity water fill. Close all sink and bathtub drains with plugs.

Briefly open all faucets and water heater drain cock and turn pump on.

Allow anti-freeze solution to circulate until it comes out of the faucets and water heater drain cock. Close all faucets and drain cock. The water pump will stop pumping automatically but you must turn the pump switch off.

Be sure to flush toilet until anti-freeze is present in bowl.

After circulating the anti-freeze through the fresh water system, remove drain plugs to allow solution to circulate through the drain system. Dump an additional 2 cups of anti-freeze into each drain.

CAUTION: DO NOT use automotive-type anti-freeze in the fresh water system; it is poisonous.

AQUA MAGIC TOILET

Turn the flush knob or step on the large pedal and insert a round object, such as a soft drink bottle, into the bowl outlet of the toilet. Slowly release the knob or pedal until the blade holds the object in place. This will prevent any water residue from being trapped inside the bowl where it could freeze. Leave the object in place all winter.

FIRE SAFETY

Prevention is the best form of fire safety. Follow the instructions previously listed for the care, maintenance and operation of the various appliances in your motor home. Make certain everyone in your party is familiar with emergency features of the unit, the locations of exits and the location and

operation of fire extinguishers. A chemical fire extinguisher has been furnished with your unit.

Follow the same rules of prevention that you would at home. DO NOT smoke in bed. DO NOT overload the electrical wiring. DO NOT use matches, candles or lighters to look into dark closets or drawers. DO NOT leave food cooking untended. DO NOT permit children to play with the controls of LP gas or electrical appliances. DO NOT store flammable liquids inside your unit.

If a fire does start, get all members of your party outside. If it is a small fire, use the fire extinguisher. If the fire cannot be extinguished quickly, GET OUT. Close the LP gas Service valve and move a safe distance from the unit. Call the fire department. DO NOT use water on the fire and DO NOT re-enter the unit until officials declare it safe to do so.

EMERGENCY EXITS

EGRESS WINDOW — An Emergency Egress window at the rear has been provided to aid in evacuating the motor home. To open, jerk the ring at the top of the window. This will pull the rubber retainer from the window, allowing the window to fall outward.

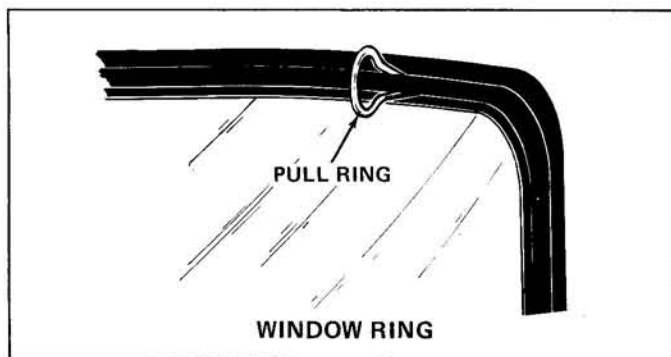

SLIDING WINDOW — Sliding windows, which can be easily opened, also may be used as an emergency exit. Press upward on the bottom of the window latch, then slide window open.

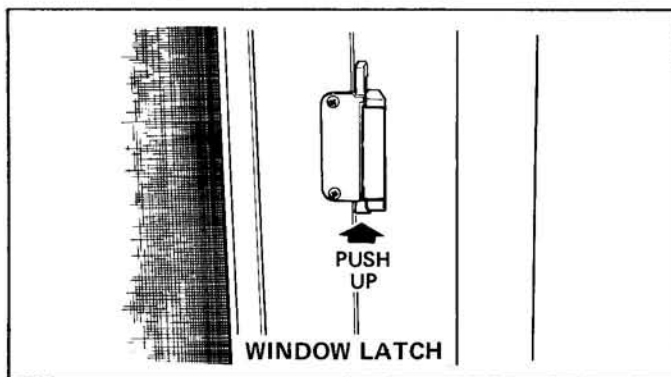

VISITING CANADA OR MEXICO

GENERAL

Passports or visas are not required for entry

into CANADA or MEXICO. However, tourist cards are necessary for MEXICO if you will be staying more than 72 hours or travel farther than 40 miles from the border. Cards can be obtained at the port of entry or from a Mexican consulate. You should carry your birth certificate, voter's registration card, baptismal certificate or similar proof of identity when entering either country. Naturalized U.S. citizens should carry their naturalization papers or other proof of citizenship. Persons under 18 years of age should carry a notarized letter from their parents or guardians giving them permission to travel in CANADA or MEXICO.

The information in this section is general in nature and subject to change by the Canadian or Mexican government. For specific information, including rules for re-entering the U.S., as well as points of interest and campsites, contact the consulate nearest the point at which you plan to enter the country.

VEHICLES

No special driver's license or permit is necessary in either country, but renew your license if it has or will expire during the trip. Proof of vehicle ownership is required at the border. If you are using someone else's unit, you should have a notarized letter authorizing its use. MEXICO requires a vehicle permit for every self-propelled vehicle. The permit can only be obtained from Mexican customs (Aduana) offices upon presentation of tourist card, vehicle registration, and title or notarized statement from owner.

CANADA requires a Canadian Non-Residential Interprovincial Motor Vehicle Liability Insurance card, which is only available from U.S. agents. All provinces in CANADA require evidence of financial responsibility if visitors are involved in an accident. Limits vary from province to province. Contact your insurance agent for details. Your insurance policy is NOT valid in MEXICO. Temporary insurance must be purchased from Mexican companies whose offices are located near the border.

CB RADIO

CB radio operation in CANADA requires a temporary license which can be obtained by writing Regional Director, Telecommunications Regulation Branch, Department of Communications, 20th Floor, 2085 Union Ave., Montreal, Quebec H3A 2C3, Canada. MEXICO currently prohibits the use of CB radios.

HUNTING AND FISHING

Each province has its own laws and license requirements. You must provide a written description and the serial number of each gun at the border. Revolvers, pistols and fully-automatic firearms are prohibited in CANADA. A license must be obtained from the province in which you intend to hunt or fish. Further information can be obtained by writing the Department of Lands and Forests,

Wildlife Branch, in the province you intend to visit. Hunting and fishing laws in MEXICO are extremely complicated. Request further information from Secretaria de Comunicaciones, Estados Unidos Mexicanos, Mexico DF.

DOGS AND CATS

CANADA requires a certificate, signed by a licensed veterinarian in the U.S. or CANADA, attesting that a dog has been vaccinated for rabies in the past 12 months. The certificate must contain a description of the dog and date of vaccination. Puppies under 3 months old need no certificate. There is no restriction on the entry of healthy cats.

A certificate, signed by a licensed veterinarian, describing the pet and attesting that it has had a rabies shot in the past 6 months, is required in MEXICO. A fee is charged for the required verification of the certificate by a Mexican consulate.

EMERGENCY CONTACTS

DOCTOR	NAME	_____	NAME	_____
	ADDRESS	_____	ADDRESS	_____
	PHONE	(AC) _____	PHONE	(AC) _____
RELATIVE	NAME	_____	NAME	_____
	ADDRESS	_____	ADDRESS	_____
	PHONE	(AC) _____	PHONE	(AC) _____
NEIGHBOR	NAME	_____	NAME	_____
	ADDRESS	_____	ADDRESS	_____
	PHONE	(AC) _____	PHONE	(AC) _____
FRIEND	NAME	_____	NAME	_____
	ADDRESS	_____	ADDRESS	_____
	PHONE	(AC) _____	PHONE	(AC) _____
POLICE	PHONE	(AC) _____	PHONE	(AC) _____
FIRE	PHONE	(AC) _____	PHONE	(AC) _____
INSURANCE AGENT	NAME	_____	NAME	_____
	ADDRESS	_____	ADDRESS	_____
	PHONE	(AC) _____	PHONE	(AC) _____

SPECIFICATIONS

CAPACITIES

ITEM		23' SB	23' RB	26' SB	26' RB
LPG TANK	(LBS.)	62	62	62	62
WATER TANK	(GAL.)	40	40	40	40
WATER HEATER	(GAL.)	6	6	6	6
HOLDING TANKS					
GRAY WATER	(GAL.)	12	12	16	12
WASTE	(GAL.)	23	23	23	23

12 VDC LIGHT BULBS

Porch	LW3-105
Interior	1141
Interior Step & Convenience	8142
Range Hood	25-Watt

FUSES

Water Pump	15-amp. Slo Blo
12 VDC Circuits	15-amp. Slo Blo

ADDITIONAL ALLOWANCE FOR EXTERIOR HEIGHT

If your Motor Home is equipped with optional roof mounted air conditioner(s), add 1'-1" to the height dimension given in the Chassis and Body Operating Manual – "Specifications" section.

NOTE: See the Chassis and Body Operating Manual – "Specifications" section for further information.

APPLIANCE IDENTIFICATION FORM

Should your unit or one of the appliances require warranty service, you will have to identify the manufacturer, model designator and serial number. Fill in this form as soon as possible. It will help you meet our identification requirement. Depending on your unit, certain items listed below may not be offered as either optional or standard. Most of this information can be found on the Recreational Vehicle Data Card attached to the inside of one of the kitchen cabinet doors.

EQUIPMENT	MANUFACTURER	MODEL DESIGNATOR	SERIAL NUMBER
Motor Home Chassis	GMC	_____	_____
Body and Interior	Jimmy Motor Homes Division of Coachmen Industries, Inc.	_____	_____
Furnace	_____	_____	_____
Range and Oven	_____	_____	_____
Converter	_____	_____	_____
Refrigerator	_____	_____	_____
Water Pump	_____	_____	_____
Water Heater	_____	_____	_____
Roof Air Conditioner(s)	_____	_____	_____
Generator	_____	_____	_____
Antenna	_____	_____	_____
Toilet	_____	_____	_____
Ignition Key	_____	_____	_____
Door Key	_____	_____	_____
Exterior Storage Compartment Keys	_____	_____	_____
Micro Wave	_____	_____	_____

MISCELLANEOUS — See the advertising brochure for the exterior dimensions and weight ratings which pertain to your unit.

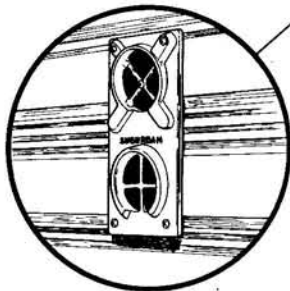
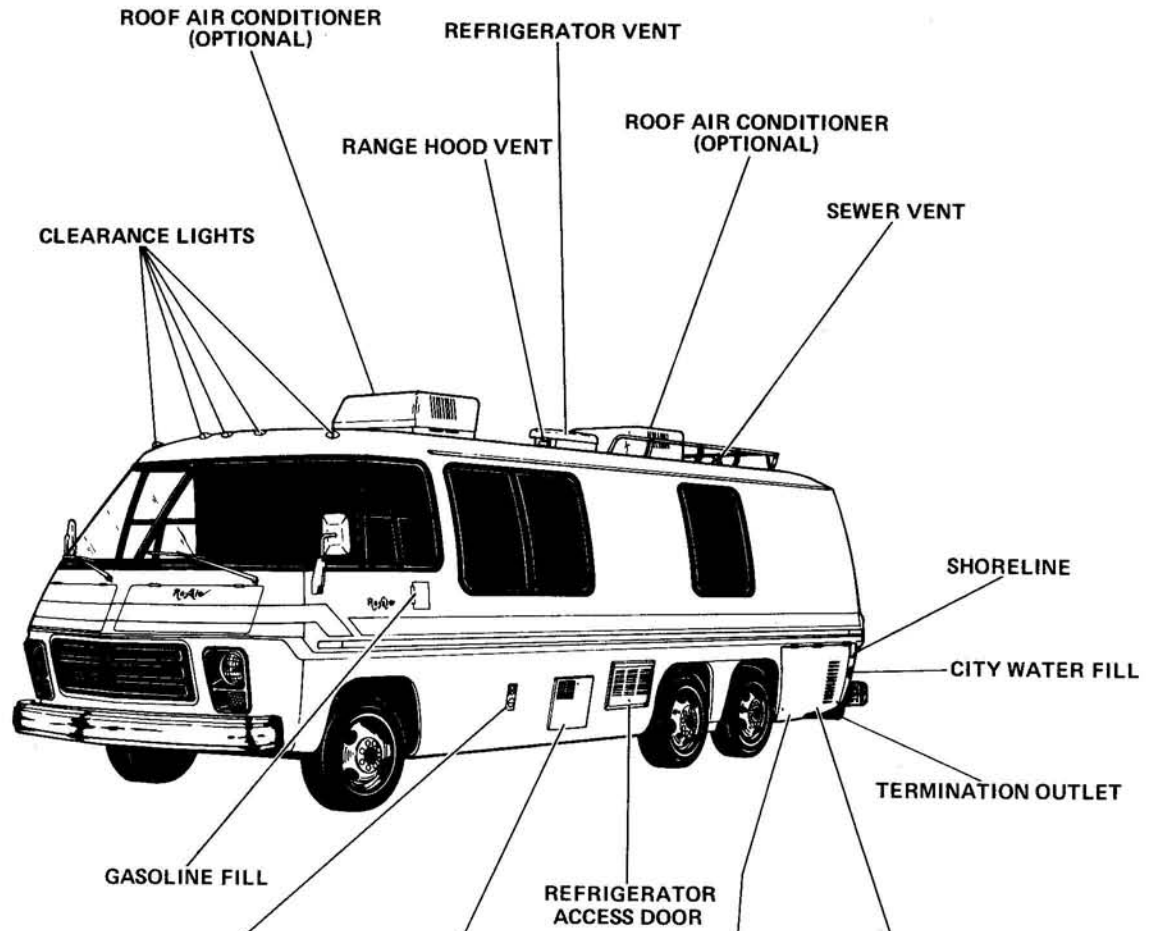

FURNACE INLET/EXHAUST
FIGURE 12

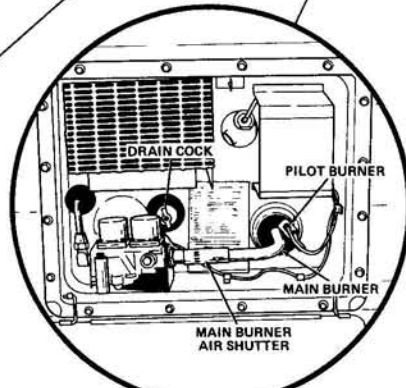

WATER HEATER
FIGURE 11

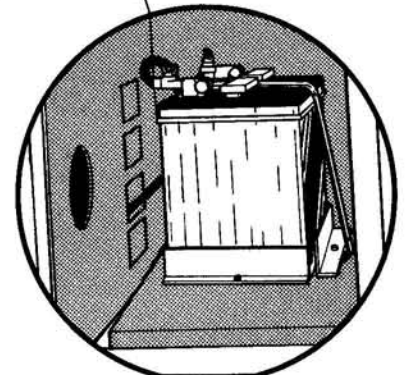

RV BATTERY
FIGURE 4

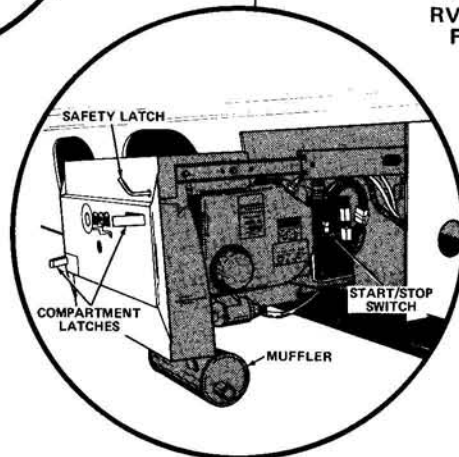

GENERATOR
FIGURE 5

JIMMY MOTOR HOME

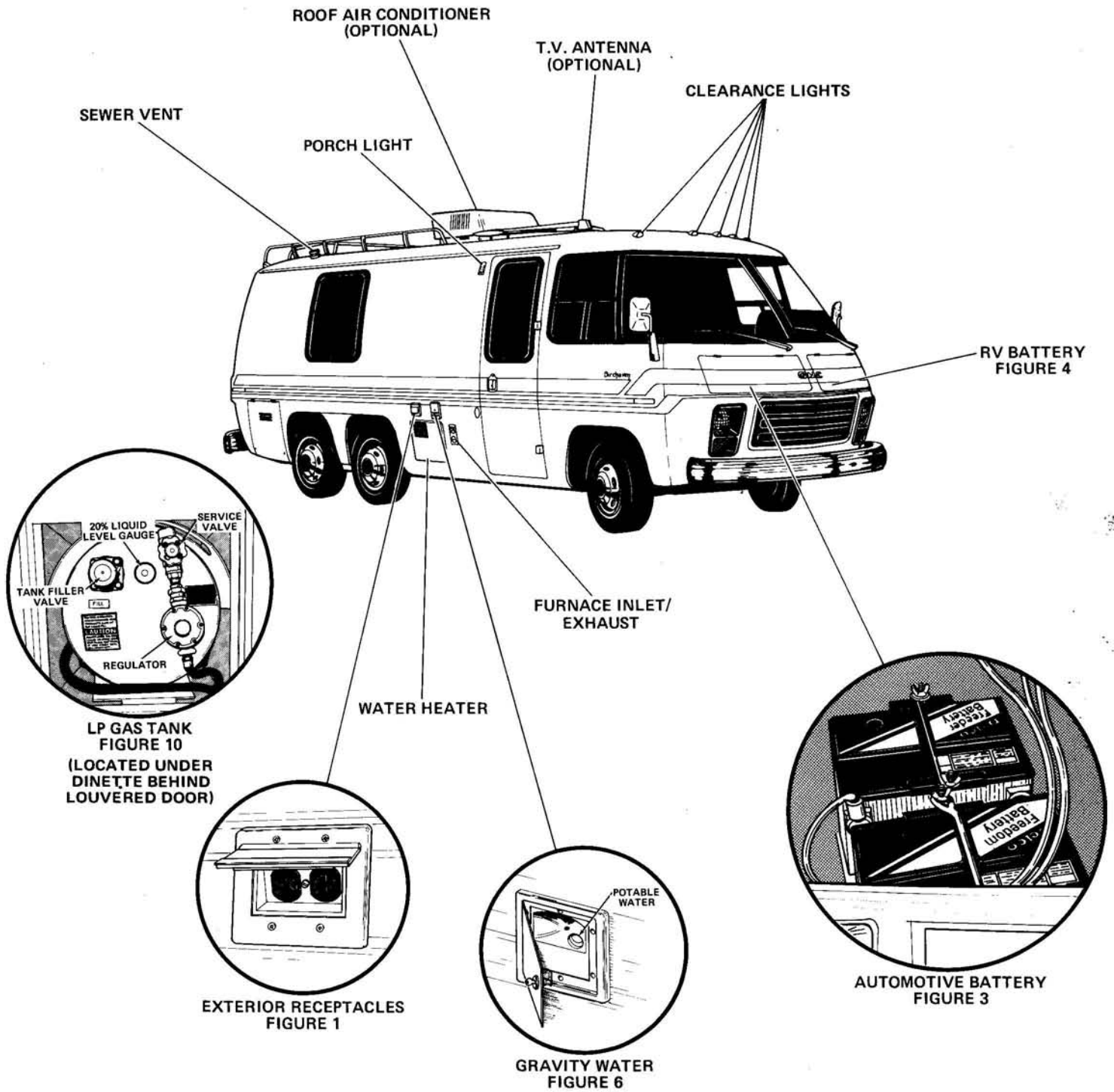

VEHICLES SHOWN ARE FOR ILLUSTRATION PURPOSES ONLY; SOME ITEMS SHOWN ARE OPTIONAL OR MAY NOT BE AVAILABLE ON CERTAIN MODELS.

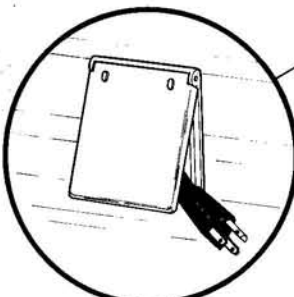
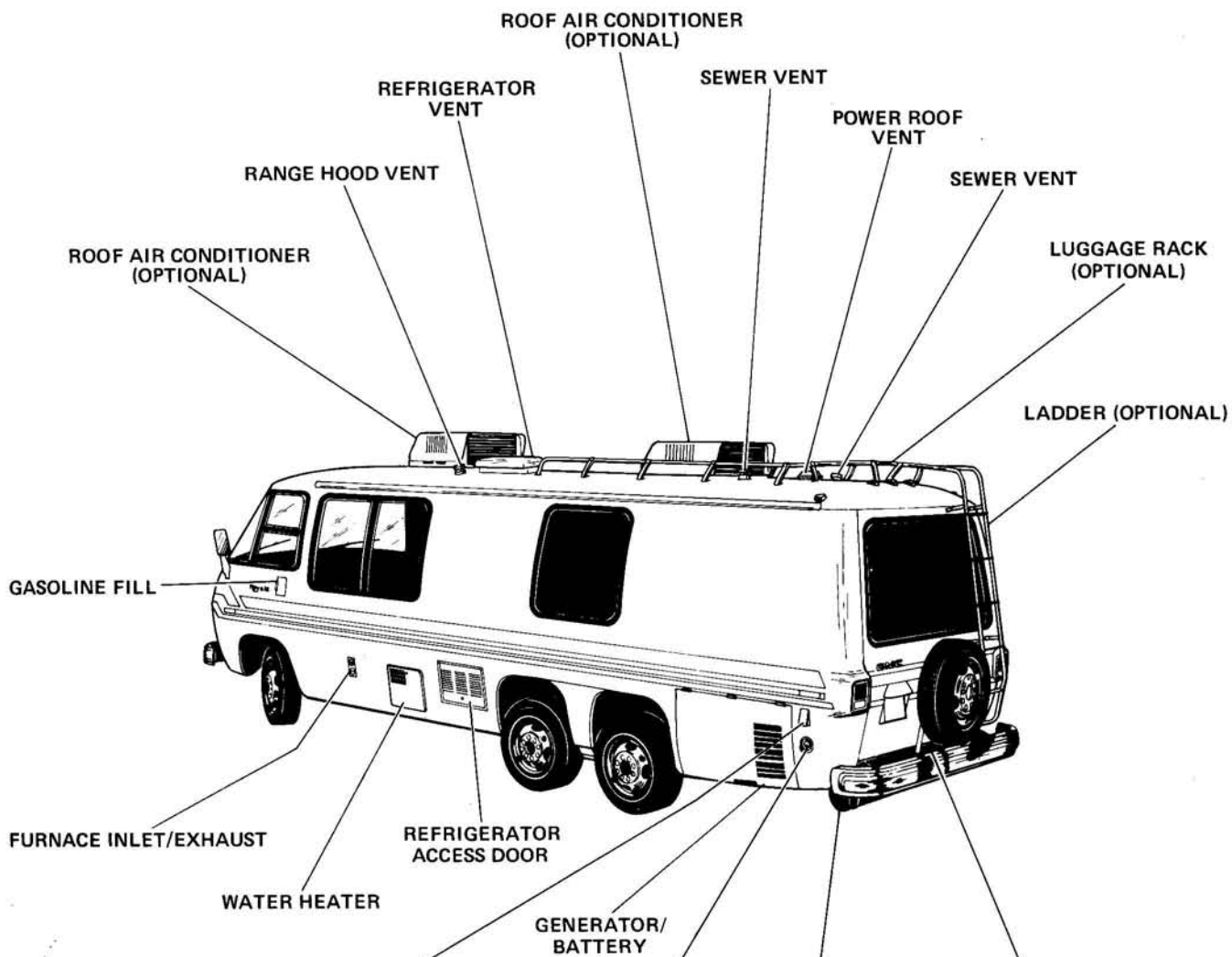

SHORELINE
FIGURE 2

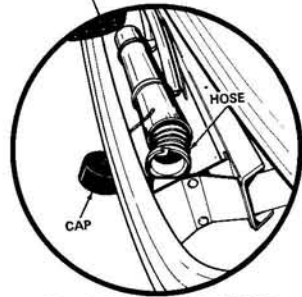

SEWAGE DRAIN HOSE
FIGURE 8

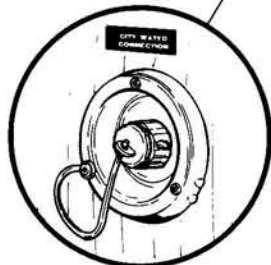

CITY WATER
FIGURE 7

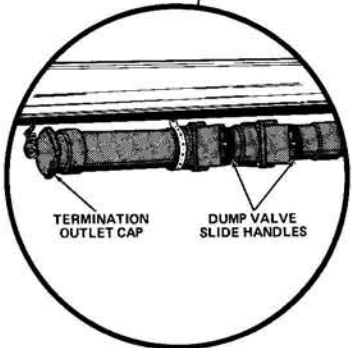

TERMINATION OUTLET
FIGURE 9



Welcome to the world of luxurious, but practical transportation. As a Jimmy owner, you join an exclusive group of satisfied GMC travelers.

Jimmy offers you the thing you want most: quality. Quality supported by a nationwide dealer network. Your Jimmy Owner Registration Card is your guarantee to fast one-stop service — for everything.

Your authorized Jimmy dealer can provide you with service on your GMC chassis as well as the Jimmy body.



Jimmy MOTOR HOMES

DIVISION OF COACHMEN INDUSTRIES, INC.

1100 N. Woodlawn Ave. Elkhart, Indiana 46514 Telephone 219-262-2645