

**QUADRAJET**

**Carburetor**

**9D-5**

**March 1981**

**Supersedes 9D-5**

**Dated May 1973**

**Models 4MV-4MC-M4ME-M4MC**

**Service Manual**

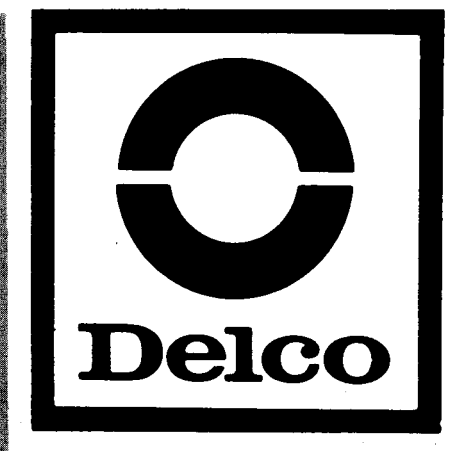

## IMPORTANT SAFETY NOTICE

Proper service and repair is important to the safe, reliable operation of all motor vehicles. The procedures recommended by Rochester Products Division of General Motors and described in this service manual are effective methods of performing service operations. Some of these service operations require the use of tools specially designed for the purpose. The special tools should be used when and as recommended.

It is important to note that this manual contains various CAUTIONS and NOTICES which should be carefully read in order to minimize the risk of personal injury to service personnel or the possibility that improper service methods will be followed which may damage the vehicle or render it unsafe. It is also important to understand that these Cautions and Notices are not exhaustive. Rochester Products could not possibly know, evaluate and advise the service trade of all conceivable ways in which service might be done or of the possible hazardous consequences of each way. Consequently, Rochester Products has not undertaken any such broad evaluation. Accordingly, anyone who uses a service procedure or tool which is not recommended by Rochester Products must first satisfy himself thoroughly that neither his safety nor vehicle safety will be jeopardized by the service method he selects.

All information, illustrations, and specifications contained in this manual are based on the latest product information available at time of publication approval. The right is reserved to make changes at any time without notice.

## CONTENTS

<b>GENERAL DESCRIPTION .....</b>	<b>3</b>
<b>OPERATING SYSTEMS .....</b>	<b>4</b>
<b>MAJOR SERVICE OPERATIONS.....</b>	<b>26</b>

NOTE: USE THIS MANUAL PLUS SECTIONS 9D-5A & 9D-5S FOR COMPLETE SERVICE INSTRUCTIONS.



## TYPICAL MODELS—4MV-M4ME

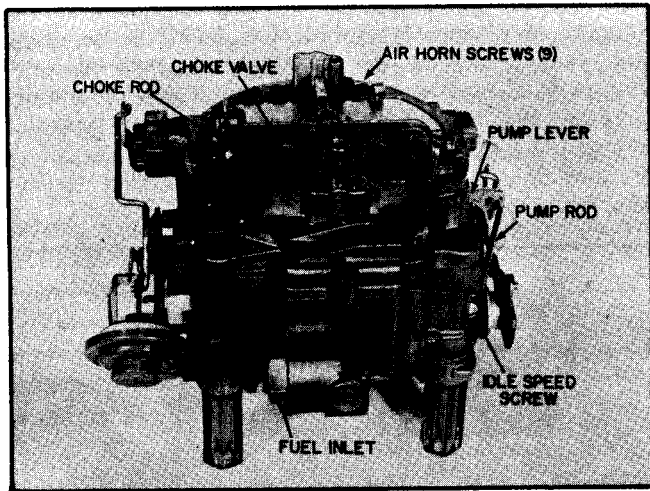

Figure 1 Model 4MV

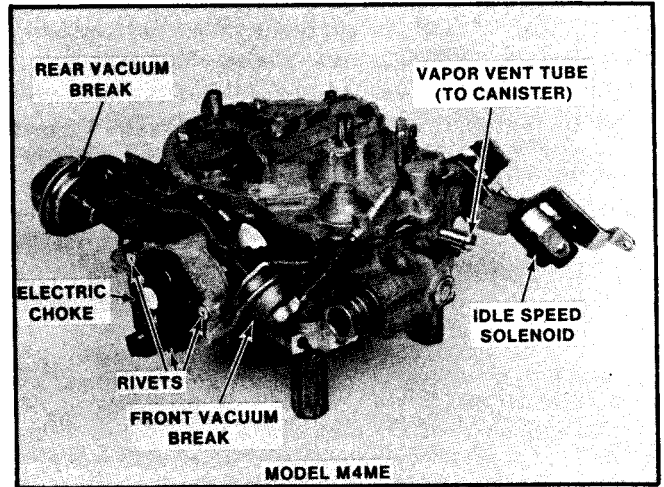

Figure 2 Model M4ME

### GENERAL DESCRIPTION

The Rochester Quadrajets is a four barrel, two stage carburetor of down draft design. It has been proven to be dependable and a versatile performer as witnessed by its broad application and usage since its first introduction in 1965. Modern demands for greater fuel economy and improved emission control have resulted in significant refinement of the original design. The Rochester Quadrajets has evolved to the point of being an efficient and sophisticated fuel control device that is right for the times and yet maintains the serviceability that is so important to those responsible for vehicle performance and customer satisfaction.

The Quadrajets carburetor has two distinct and separate design stages. Each stage operates to provide a blend of economical operation and responsive engine performance.

The primary side of the carburetor (fuel inlet side) has two small bores. Each bore contains a triple venturi arrangement equipped with plain tube nozzles. The triple venturi provides excellent fuel atomization and delivery in the off idle and part throttle ranges of engine operation.

Fuel metering is controlled through the usage of tapered primary metering rods that are suspended within finely machined metering jets. The metering rods are moved vertically by engine vacuum control. This is accomplished by the use of a spring-loaded piston and rod hanger assembly and results in the control of fuel allowed to pass through the metering jets and to the engine during low speed and moderate speed operation.

Some models use multiple stage enrichment methods that may incorporate additional rods, jets and/or power piston arrangements. There are models that have devices that respond to changes in atmospheric pressure as well. The objective is to provide a high degree of sensitivity to air/fuel mixture control at lower and midrange engine speeds. The primary side of the Quadrajets carburetor

has the design features to meet these needs. The individual systems are described in detail later in sections of this text.

The secondary side of the Quadrajets has two larger bores. This increased area, when combined with that of the primary side of the carburetor, provides an air delivery capacity that can satisfy a broad range of engine operating conditions.

An air valve, positioned above the secondary bores, controls the fuel delivery for high demand conditions. This secondary air valve is connected mechanically to a pair of secondary metering rods that are tapered and are suspended within a pair of fuel metering orifices. The fuel passing through these secondary orifices is directed to a set of delivery nozzles located at the top of each secondary bore and below the air valve. The fuel flow through the nozzles is thereby controlled in direct proportion to air flowing through the secondary bores.

There are two basic carburetor model designs:

First released in 1965, the 4MV is an automatic choke model designed for use with a manifold mounted thermostatic choke coil. The 4MC model also is an automatic choke carburetor but with the choke thermostatic coil located in a choke housing mounted on the side of the float bowl. Except for choke systems, all models have basically the same principles of operation (Figure 1).

First released in 1975, the M4ME models differ from the conventional 4MV-4MC carburetor models in that the "M" prefix designates "modified", indicating the primary side is revised to accommodate an adjustable metering rod assembly with filler spool, or aneroid-metering rod assembly, where required, and the auxiliary power piston assembly (if used). The aneroid feature is normally used to achieve altitude compensation in air/fuel mixtures (designated Models M4MCA-M4MEA) (Figure 2).



Later "modified" models use separated main wells with an aneroid cavity insert in the float bowl replacing the adjustable metering rod or aneroid-metering rod assembly.

On all models, the fuel chamber is centrally located to avoid problems of fuel spillage causing engine turn cut-out and delayed fuel flow to the carburetor bores. The fuel chamber is relatively small in volume to reduce fuel evaporation during hot engine "shutdown". A plastic bowl insert is included to reduce the free volume above the fuel level to prevent fuel loss to the main metering jets during critical vehicle maneuvers.

The float system has a single pontoon float and fuel inlet valve for simplification and ease of servicing. An integral fuel filter (or strainer), and check valve (if used), located in the float bowl ahead of the fuel inlet valve, is easily removed for cleaning or replacement.

All models have an Adjustable Part Throttle (A.P.T.) screw located either in the throttle body (since 1968 on 4MV-4MC models) or in the float bowl ("M" modified models) to aid in refinement of fuel mixtures for good emission control.

The thermostatic choke coil assembly on 4MV models is heated by hot exhaust gases that flow through a special passage in the intake manifold. On 4MC-M4MC and M4MCA models, the thermostatic coil assembly is warmed by exhaust heated air supplied through a tube to the choke housing mounted on the float bowl. M4ME and M4MEA models use an electrically heated thermostatic coil assembly to control choke mixtures after engine start and cold driveaway.

The throttle body is aluminum to reduce overall weight and to improve heat distribution, plus there is a thick throttle body to bowl insulator gasket to keep excessive heat from the float bowl causing fuel percolation.

Some Quadrajets applications use a shim between the throttle body and flange gasket. The shim is used to protect the carburetor aluminum throttle body from exhaust gases flowing through the heat cross-over or exhaust gas recirculation passage in the intake manifold.

## CARBURETOR IDENTIFICATION

Early Quadrajets carburetors (Figure 3) have the model number identification stamped on a circular tag pressed into a recess on the float bowl casting in a flat area on the throttle lever side. Later model Quadrajets

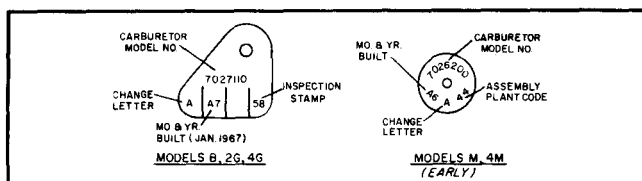

Figure 3 Carburetor Identification Tag - Early Models

carburetors have no tag but include the part number stamped vertically on the left rear corner of the float bowl casting adjacent to the secondary pick-up lever (Figure 4). If replacing the float bowl, follow the manufacturer's instructions contained in the service package so that the identification number can be transferred to the new float bowl. Refer to the part number on the bowl when servicing the carburetor.

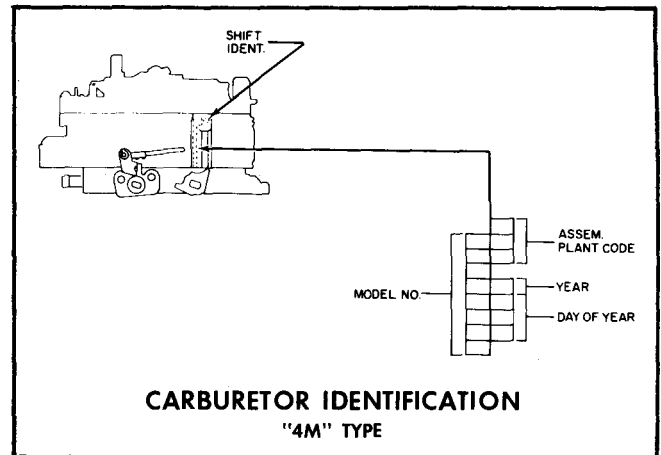

Figure 4 Carburetor Identification Location - Late Models

## SERVICE FEATURES

The primary side of the carburetor has six operating systems. They are float, idle, main metering, power, pump, and choke. All systems receive fuel from one fuel chamber.

The following text covers the operating systems for ease in trouble-shooting and also recommended service procedures. There are some design variations between different models which will be covered in that part of the text pertaining to that particular system or service procedure.

## OPERATING SYSTEMS

### FLOAT SYSTEM

The Quadrajets carburetor has a centrally located fuel chamber in the float bowl (Figure 5). The fuel chamber is centered between the carburetor bores to assure an adequate fuel supply to all metering systems with respect to car inclination or severity of turns.

The float system (Figures 6 or 7) consists of a fuel chamber, fuel filter (with check valve on M4MC-M4ME applications) or a fuel inlet strainer (some 4MV applications), a single closed-cell plastic pontoon with integral float lever, a float hinge pin, float valve and pull-clip, float valve seat (with or without "windows"), and internal vents. Also, some applications include either an idle vent valve, vacuum vent switch valve, or external

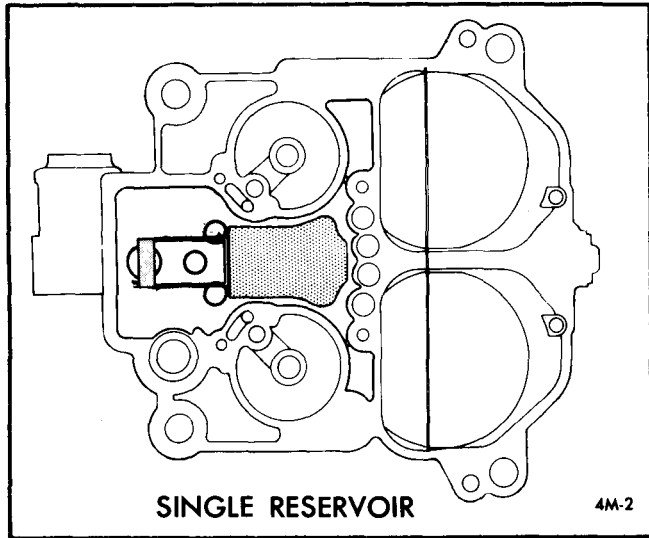

Figure 5 Centralized Fuel Chamber

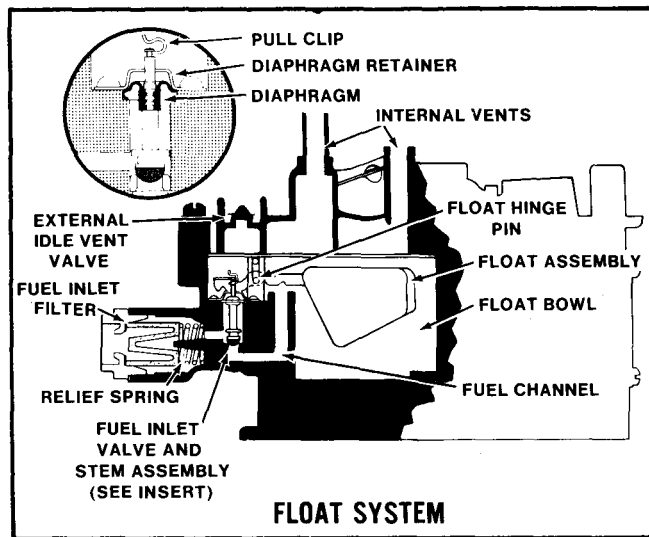

Figure 6 Float System 4MV-4MC

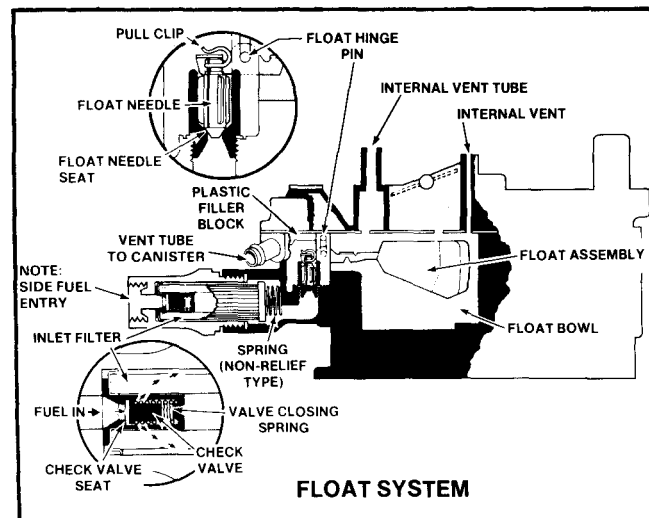

Figure 7 Float System M4MC-M4ME

vent connector tube leading to the vapor canister, to vent excessive fuel vapors that form in the fuel chamber above the fuel surface that could disrupt hot engine operation. A plastic filler block is located in the top of the fuel chamber over the float valve to prevent fuel slosh in this area. On M4MC and M4ME models, either a filler spool or an aneroid cavity insert is used in the fuel chamber to reduce fuel slosh on turns. Also, a metal baffle is added to the pump well fill slot in the float bowl of M4MC-M4ME models to reduce fuel slosh during various vehicle maneuvers.

On most models, an integral 1-inch or 2-inch pleated paper fuel inlet filter, dependent upon model, is mounted in the front of the float bowl behind the fuel inlet nut to filter impurities from the incoming fuel. If used, a check valve is pressed into the neck of the fuel filter. The check valve consists of a plastic disc contained in a plastic retainer. It is held in the normally closed position by a small spring which exerts pressure on the check valve. When the engine starts and fuel flow pressure from the fuel pump enters the inlet nut, it pushes the small check valve off its seat. Fuel flows past the valve into the inside of the filter and continues on through the filter to the float valve and seat. With the engine off, the check valve closes and shuts off fuel flow to the carburetor to prevent fuel leaks if a vehicle roll-over should occur.

The check valve retainer also has a flanged neck which seals between the filter and fuel inlet nut.

**NOTICE:** If used, the check valve must be installed to meet government safety standards for roll-over. New service replacement filters include the check valve where required.

The fuel filter is held in position by the force of a spring located between the filter assembly and the fuel inlet nut cavity.

**NOTICE:** It is very important that the filter be serviced according to recommended maintenance intervals to prevent dirt and other impurities from entering the carburetor metering orifices.

The float system operates in the following manner:

Fuel flow from the fuel pump enters the carburetor fuel inlet nut. It opens the check valve (if used) in the filter against spring force and flows through the filter element (or strainer), and then passes from the filter chamber up through the float valve seat and flows past the float valve on into the fuel chamber. As the incoming fuel enters the fuel chamber, the float pontoon rises and forces the float valve closed, shutting off fuel flow at a prescribed level. As fuel is used from the fuel chamber, the float pontoon drops to open the float valve allowing fuel to again enter the fuel chamber. This cycle continues, maintaining a near constant fuel level in the fuel chamber for all ranges of engine operation.

A float pull clip, fastened to the float valve, hooks



over the edge of the float lever at the center as shown in Figures 6 or 7. Its purpose is to assist in lifting the float valve off its seat whenever fuel level in the fuel chamber is low.

**NOTICE:** Do not place pull clip through small holes in top of float lever. Severe flooding will result.

There are two types of float valves used in the Quadra-jet carburetor: One type is diaphragm assisted and the other is the conventional needle and brass seat.

The diaphragm assisted float valve (shown in the inset Figure 6) is used primarily with a smaller float and on engines equipped with high pressure fuel pumps. The valve seat is a brass insert and is pressed into the bowl fuel inlet channel below the diaphragm needle tip. The seat is not removable, as the valve tip is of a material which makes seat wear negligible. Care should be used during servicing so that the seat is not nicked, scored, or moved. The float valve is factory staked and tested and should not be re-staked in the field.

Fuel flow through the diaphragm assisted float valve varies from the conventional float needle. With the conventional type (as shown in Figure 7) fuel flows from the inlet filter and inlet channel up through the needle seat orifice past the float needle valve and spills over into the float bowl. With the diaphragm type float valve, fuel from the inlet filter enters the channel above the float valve tip. When fuel level is low in the bowl, the float valve is off its seat and fuel flows down past the valve tip into a fuel channel which leads upward through the bowl casting to a point above normal liquid level and spills over into the float bowl.

The diaphragm type float valve differs in operation from the conventional float needle in that a larger seat orifice can be used to provide greater fuel flow to the float chamber and yet allow the use of a small float. This is accomplished through a balance of forces acting on the float valve and diaphragm against fuel pump pressure. Fuel pressure entering the float valve chamber tends to force the valve closed. However, the same pressure is also acting on the float valve diaphragm. The diaphragm has a slightly larger area than the float valve head, therefore the greater pressure acting on the diaphragm tends to push the valve off its seat. The force of the float arm acting on the valve stem, as the float bowl fills, overcomes this pressure difference and closes the valve. Therefore, the float's function is to overcome the pressure difference and it does not have to force a valve closed against direct fuel pump pressure as does the conventional needle type.

To improve hot engine starting and to prevent rough idle which may result from excessive fuel vapors that may form in the fuel chamber, various methods have been used to vent these vapors external to the carburetor.

Early Quadrajet applications vented these vapors to the atmosphere through an idle vent valve that is operated

mechanically. A wire tang on the pump lever opens the valve during idle and allows the valve to close at greater throttle valve angles as in the off idle and part throttle positions.

Some models use a thermostatically controlled vent valve (Figure 8). This heat sensitive valve is operated by a bi-metal strip which holds the valve closed at temperatures below 75°F. When temperatures at the carburetor exceed that value the valve opens allowing vapors to escape. The thermostatic vent valve is adjustable to make sure it is timed to open during idle and closed at higher engine speeds.

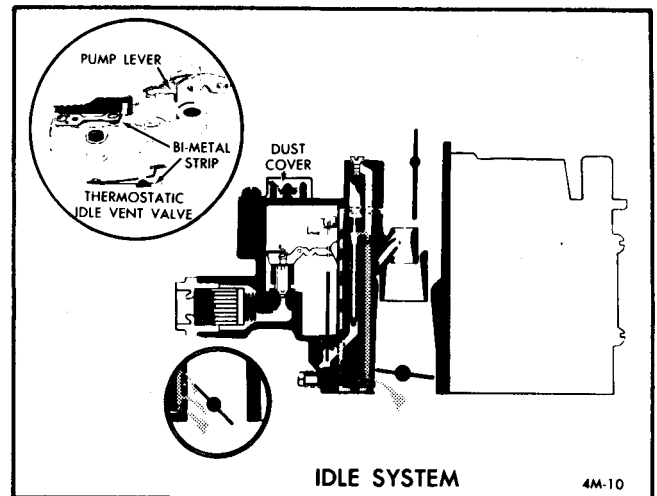

Figure 8 Thermostatic Idle Vent Valve

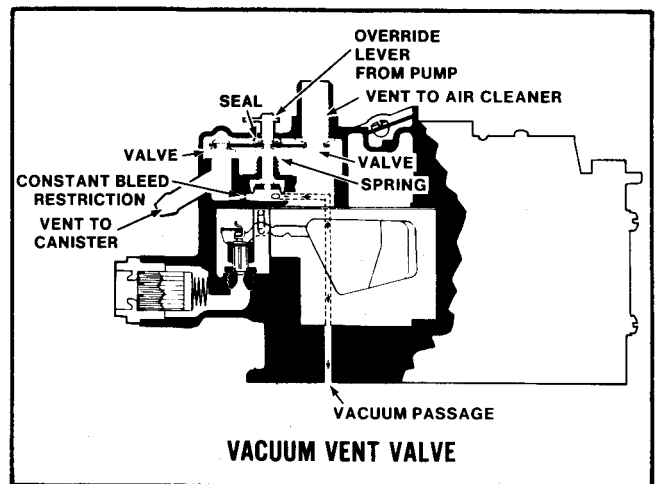

Figure 9 Bowl Vent Valve

Some Quadrajets have a vacuum operated vent valve (Figure 9) that is also controlled to function with an evaporative vapor canister. The vacuum vent valve is designed to be open and to allow fuel chamber vapors to be routed directly to a vapor collection canister instead of the atmosphere for improved evaporative emission control during engine shut-down. A passage beneath the vacuum diaphragm in the air horn pro-

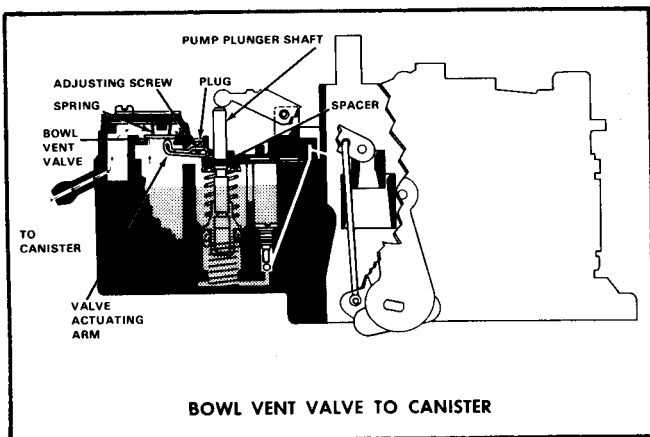

Figure 10 Bowl Vent Valve

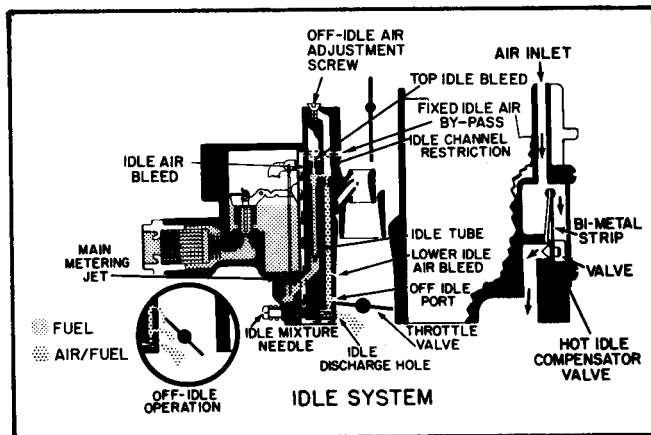

Figure 11 Idle System - Typical

vides a constant purge of the vapors from the vapor canister during off idle and higher engine speeds.

Later "modified" versions of the Quadrajets have a bowl vent valve that is spring-loaded and is actuated by action of a spacer on the pump plunger shaft (Figure 10). The fuel chamber is externally vented to the vapor collection canister during periods of engine shut-down.

Another method used to vent vapors is by the addition of a tube to the air horn (see Figure 7). Vapors flow through this tube and connecting hose to a vacuum operated vapor vent valve that is an integral part of the vapor collection canister located elsewhere in the engine compartment. The canister vent valve is spring-loaded and normally open, allowing bowl vapors to pass into the canister during engine shut down. Manifold vacuum during engine operation closes the valve and vapors are purged from the canister. This system improves hot engine starting and also meets government evaporative emission requirements.

**NOTICE:** External venting of fuel chamber vapors is not used on Quadrajets carburetors designed for marine use.

## IDLE SYSTEM

The Quadrajets carburetor idle system is located on the primary side (fuel inlet side) of the carburetor to supply the correct air/fuel mixture during idle and off-idle operation.

The idle system is used during this period because air flow through the carburetor venturi is not great enough to obtain efficient metering from the main discharge nozzles. The idle system is only used in the two primary bores of the carburetor. Each bore has a separate and independent idle circuit (Figure 11).

The idle system consists of a calibrated idle tube, air bleeds, idle channel restriction, idle mixture discharge hole, and idle mixture screws or needles (one for each bore).

The idle system operates as follows:

During curb idle (warm engine), the primary throttle valve is held slightly open by the idle speed screw or solenoid plunger. The small amount of air passing between the throttle valve and bore is regulated by adjusting the position of the speed screw or solenoid plunger to obtain the desired idle speed. Since the engine requires very little air for idle and low speed, fuel is added to the air to produce a combustible mixture by the direct application of vacuum (low pressure) from the intake manifold to the idle discharge hole below the throttle valve. The idle discharge hole is in a very low pressure area and the fuel in the fuel chamber is vented to atmosphere (high pressure through the air cleaner). This causes fuel to flow from the fuel chamber down through the main metering jet into the main fuel well. It is picked up in the main well by the idle tubes (one for each bore) which extend into the fuel well. The fuel is metered at the lower tip of the submerged idle tube and passes up through the tube. At this point, the fuel is mixed with air at the top of each idle tube through the top idle air bleed. The air bleed size is controlled by either a drilled hole or a brass insert depending upon carburetor application.

**NOTICE:** No attempt should be made to install a brass insert in those applications that use a drilled hole for the top idle air bleed.

Then the fuel mixture crosses over to the idle down channel where it is mixed with air at the side idle bleed located just above the idle channel restriction. The mixture continues down through the calibrated idle channel restriction past the lower idle air bleed and off-idle discharge port where it is further mixed with air. The air/fuel mixture moves down to the adjustable mixture screw discharge hole where it enters the carburetor bore and blends with the air passing by the slightly open throttle valve. The combustible air/fuel mixture then passes through the intake manifold to the engine cylinders.





The idle mixture screws are adjustable to blend the correct amount of air/fuel mixture from the idle system to the engine at idle. Turning the mixture screws inward (clockwise) decreases idle mixture discharge (gives a leaner mixture) and turning the mixture screws outward (counter-clockwise) increases idle mixture discharge (gives a richer mixture).

## OFF-IDLE OPERATION

As the primary throttle valve is opened from curb idle to increase engine speed, additional fuel is needed to combine with the extra air entering the engine. This is accomplished by the slotted off-idle discharge port. As the primary throttle valve opens, it passes by the slotted off-idle discharge port, gradually exposing it to high manifold vacuum. The mixture added from the off-idle port mixes with the increasing air flow past the opening throttle valve to maintain the required air/fuel mixture of the engine.

Further opening of the throttle valve increases the air velocity through the carburetor venturi sufficiently to cause low pressure at the lower idle air bleed. As a result, fuel begins to discharge from the lower idle air bleed hole and continues throughout operation of the part throttle to wide-open ranges, thereby supplementing main discharge nozzle delivery.

The idle mixture screw discharge hole and off idle discharge port continue to supply sufficient fuel for engine requirements until air velocity is high enough in the venturi area to obtain efficient fuel flow from the main metering system.

The idle system functions in a similar manner in each carburetor bore.

The secondary throttle valves remain closed during idle conditions and on some Quadrajet applications they are coated with a special graphite material which is applied at the factory to effectively seal the secondary throttle valves in the bores for minimum air flow at idle to prevent possible rough idle.

On many exhaust emission control carburetor applications, the idle mixture screw discharge holes have been reduced in size. This was done to prevent a too rich idle adjustment in the field should the idle mixture screws be turned out too far beyond normal idle mixture requirements. Also, starting in 1971, idle screw limiter caps were added to emission control carburetors to discourage adjustment of the screws in the field. On later models, the idle mixture screws are sealed to prevent readjustment from the factory setting in the field.

## ADJUSTABLE AIR BLEED

Another feature added to some emission carburetors is an adjustable off-idle air bleed system (Figure 11). A separate air channel is added in the air horn which leads

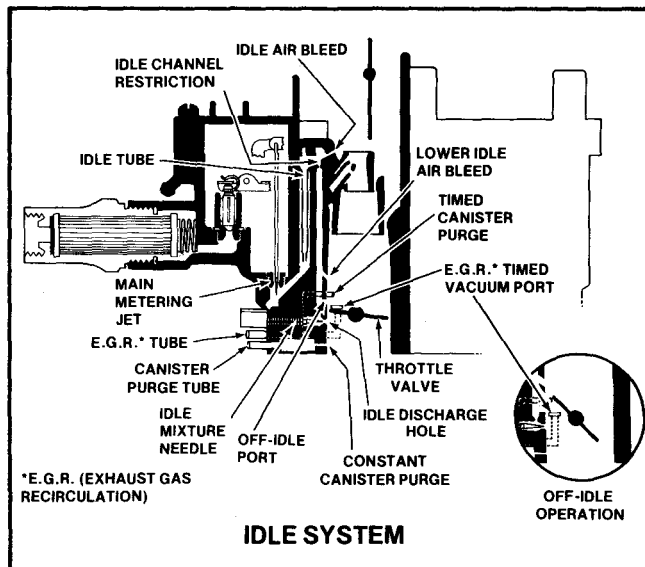

Figure 12 Idle System - Late Models

from the top of the air horn to the idle mixture cross channel. An adjustment screw with a tapered head is mounted at the top of the channel and is used to control the amount of air bleeding into the idle system. The off-idle air bleed is adjusted at the factory to maintain very accurate off-idle air/fuel mixture ratios. It is adjusted during carburetor flow test and no attempt should be made to readjust in the field. A triangular spring clamp forced over the vent tube covers the screw to protect the adjustment from being tampered with and it should not be removed. All service air horns have this screw preset at the factory.

## FIXED IDLE AIR BY-PASS

A fixed idle air by-pass system is used on some applications which consists of air channels that lead from the top of each carburetor bore in the air horn to a point below each throttle valve. At normal idle, extra air passes through these channels supplementing the air passing by the slightly open throttle valves. The purpose of the idle air by-pass system is to reduce the amount of air going past the throttle valves so that they are nearly closed at idle. This reduces the amount of air flowing through the carburetor venturi to prevent the main discharge nozzles from feeding fuel during idle operation. The triple venturi system is very sensitive to air flow and where large amounts of idle air are needed to maintain idle speed, the fixed idle air by-pass system is used.

## PURGE PORTING

To meet evaporative emission standards on late model Quadrajet applications, fuel vapors from the carburetor float bowl and fuel tank are collected in a vapor canister and not vented to atmosphere. On many of these





carburetor models, vacuum ports are located in the throttle body for canister purge. The purge ports lead through passages to a tube in the throttle body which connects by a hose to the vapor canister.

The purge ports may consist of a constant (fixed) canister purge and a separate timed canister purge, or a timed canister purge only (Figure 12).

The purge system operates as follows:

## CONSTANT CANISTER PURGE

The constant canister purge port operates during idle operation of the engine. It is located below the throttle valves to provide a constant purge of the canister whenever the engine is running. As the throttle valves are opened beyond the idle position, additional purge of the canister is provided by each of the timed purge ports.

## TIMED CANISTER PURGE

The timed canister purge ports operate during off-idle, part throttle, and wide-open throttle operation. They are located above the throttle valve in each bore next to the off-idle discharge port. The timed purge ports supplement the constant canister purge port (where used) to provide a larger purge capacity for the vapor canister and to prevent over-rich mixtures from being added to the carburetor metering at any time.

On some applications (see Figure 12), the constant purge port is used as the vacuum source to the Early Fuel Evaporation (E.F.E.) Valve located in the exhaust manifold. On these models, purging of the canister is accomplished through the Positive Crankcase Ventilation (P.C.V.) system.

## EXHAUST GAS RECIRCULATION

An Exhaust Gas Recirculation (E.G.R.) system, consisting of an E.G.R. Valve, separate back-pressure transducer valve (where used), vacuum hoses, and vacuum supply ports in the Quadrajets carburetor, is used on many vehicle applications to meet exhaust emission requirements. The E.G.R. valve is operated by a vacuum signal taken from the carburetor. The vacuum signal, dependent upon application, is taken from one or two punched ports located in the carburetor bore just above the throttle valves. Thus, E.G.R. valve operation is "timed" for metering exhaust gases to the intake manifold dependent upon location of the ports in the carburetor primary bore and by the degree of throttle valve opening (See Figure 12).

It is important that the E.G.R. vacuum signal port(s) not be exposed to manifold vacuum during engine idle and deceleration to keep the E.G.R. valve closed. This prevents rough idle which can be caused by excessive exhaust gas contamination in the air/fuel mixtures.

## TRANSMISSION CONVERTER CLUTCH

Some applications have a port located above the throttle valve that is used to supply a timed vacuum source for the automatic transmission converter clutch (see car division service manual for description of this transmission feature.)

## HOT IDLE COMPENSATOR

The Hot Idle Compensator, when used on 4MV-4MC-M4MC Quadrajets carburetors (See Figure 11), is located in a chamber at the rear of the carburetor float bowl adjacent to the secondary bores. Its purpose is to offset the enriching effects caused by excessive fuel vapors during hot engine operation.

The compensator consists of a thermostatically-controlled valve, a heat sensitive bi-metal strip, and a valve holder and bracket. The compensator valve assembly is held in place by a dust cover over the valve chamber. A seal is used between the compensator valve and the float bowl casting. The valve closes off an air channel leading from a hole in the top of the air horn, just beneath the air cleaner, to a point below the secondary throttle valves.

Normally, the compensator valve is held closed by tension of the bi-metal strip. During extreme hot engine operation, excessive fuel vapors entering the engine manifold cause richer than normally required mixtures, resulting in rough engine idle and stalling. At a predetermined temperature, when extra air is needed to offset the enriching effects of these fuel vapors, the bi-metal strip bends and unseats the compensator valve. This uncovers the air channel leading from the valve chamber to the point below the throttle valves. This allows enough air to be drawn into the engine manifold to offset the richer mixtures and maintain a smooth engine idle. When the engine cools and the extra air is not needed, the bi-metal strip relaxes, closes the valve, and operation returns to normal mixtures.

For proper idle adjustment when the engine is hot, the compensator valve must be closed. To check this, a finger may be held over the compensator air inlet channel located on top of the air horn. If no drop in engine RPM is noted on a tachometer, the valve is closed. If the valve is open, plug the hole or cool engine down to a point where the valve automatically closes for proper idle adjustment.

**NOTICE:** Plug the compensator hole with a pencil or something that will be seen, as the plug must be removed before the air cleaner is installed. Otherwise the compensator will not function if the plug is left in the hole.

On some applications, the air inlet to the hot idle compensator is located beneath the air valve in the secondary bores. The air inlet in this location improves idle quality when the



feeds additional fuel at closed choke for good cold engine starting. Calibrated air bleeds, located in the air horn, are used with this system.

The air-velocity sensitive pull-over enrichment system allows the use of slightly leaner mixtures during part throttle operation and still provides enough fuel during high speed operation. This feature gives added refinement to the fuel mixtures for exhaust emission control.

### MAIN WELL AIR BLEED TUBES

Some 4MV Quadrajets applications use Main Well Air Bleed Tubes in place of the main well air bleed holes (Figure 16). The tubes, extending further into each primary bore, help main discharge nozzle response as the main metering system starts to feed fuel.

### MAIN METERING SYSTEM M4MC-M4ME MODELS

Starting in the 1975 model year, major casting changes were made to the air horn, float bowl, and throttle body of the Quadrajets carburetor to incorporate a new Adjustable Part Throttle (A.P.T.) feature and, on some applications, the addition of an auxiliary power piston and metering rod assembly. These new models were termed "modified" and designated by the prefix "M" to the model listing (e.g., M4MC).

### ADJUSTABLE PART THROTTLE

The A.P.T. feature on these "modified" models consists of an adjustable metering rod assembly with filler spool (Figure 17-A) or combination aneroid - metering rod assembly (for an explanation of aneroid, see Altitude Compensation, below). The adjustable metering rod, with or without aneroid, provides close tolerance control of fuel flow to the main metering system during the part throttle range.

The A.P.T. adjustment is performed at the factory during flow test by turning the threaded metering rod, or aneroid-metering rod assembly, up or down to position the metering rod in a fixed metering jet located at the bottom of the fuel reservoir in the float bowl. This sets the part throttle air/fuel mixture to the desired flow band.

### ALTITUDE COMPENSATION

On M4MCA-M4MEA models, a barometric pressure-sensitive aneroid, sometimes called a "bellows", is included as an integral part of the threaded A.P.T. metering rod assembly (Figure 17-B). The aneroid, being sensitive to air pressure change, automatically either expands or contracts with changes of altitude to lower or raise the metering rod in the fixed metering jet to maintain control of part throttle air/fuel ratios.

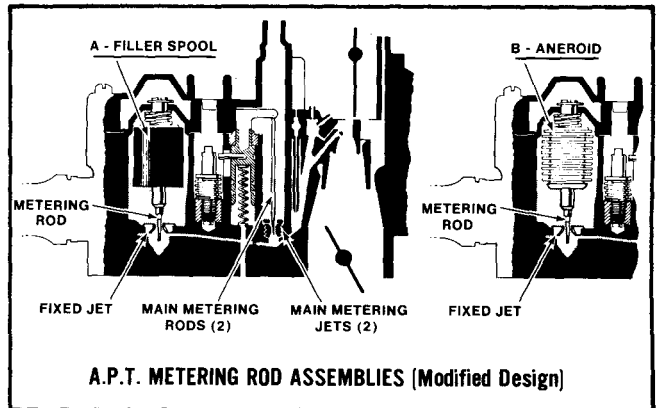

Figure 17 Adjustable Part Throttle - Modified Models

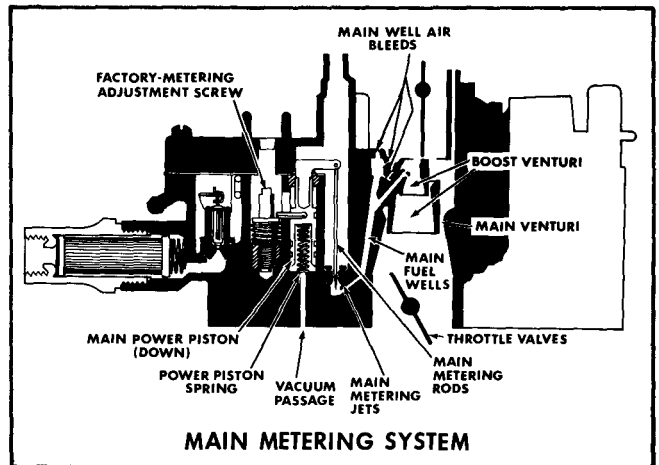

Figure 18 Separated Main Wells

**NOTICE:** The position of the A.P.T. metering rod in the fixed jet is extremely critical. Adjustment should NEVER be attempted unless a replacement is required. The threaded A.P.T. metering rod should be adjusted carefully following adjustment procedures (See step 7a, page 38).

As a result of these changes, a new float assembly, plastic filler block (located in the top of the float chamber over the float valve), and new air horn gasket are used with the "modified" carburetor models.

### SEPARATED MAIN WELLS

The main metering system of most later "modified" Quadrajets models (Figure 18) operates similarly to that described for 4MV-4MC models, above, except the float bowl casting is revised to provide for separated main wells. The separated main well feature is used to feed each main nozzle for improved fuel flow through the carburetor venturi. On these models, a special aneroid cavity insert is used in the fuel chamber to replace the adjustable metering rod assembly with filler spool, or aneroid-metering rod assembly, formerly used.



## ADJUSTABLE PART THROTTLE FEATURE

On "modified" Quadrajets carburetors that use separated main wells, the A.P.T. adjustment consists of a pin pressed in the side of the power piston which extends through a slot in the side of the piston well. When the power piston is down (economy position), the pin stops on top of a flat surface of the adjustment screw located in a cavity next to the power piston (See Figure 18). The adjustment screw is held from turning by a tension spring beneath the head of the screw.

During production flow test, the adjustment screw is turned up or down which, in turn, places the tapered metering rod at the exact point in the metering jet orifice to obtain the desired air/fuel mixture ratio to meet exhaust emission requirements.

**NOTICE:** The A.P.T. screw is preset at the factory and no attempt should be made to change this adjustment in the field. If a float bowl replacement is required during carburetor service, the new service float bowl assembly will be supplied with the adjustment screw preset as required.

## POWER SYSTEM

The power system in the Quadrajets carburetor provides extra mixture enrichment to meet power requirements under heavy engine loads and high-speed operation. The richer mixtures are supplied through the main metering system in the primary and secondary sides of the carburetor (Figure 19).

The fuel mixture is enriched in the two primary bores through the power system. This consists of a vacuum operated power piston and a spring(s) located in a cylinder connected by a passage to intake manifold vacuum. The spring(s) under the power piston apply an upward force against manifold vacuum force tending to pull the piston downward.

During part throttle and cruising ranges, manifold vacuum is sufficient to hold the power piston down against spring force so that the larger diameter of the primary metering rod tip is held in the main metering jet orifice to provide leaner mixtures during these periods of engine operation. However, as the engine load is increased to a point where extra mixture enrichment is required, the power piston spring force overcomes the vacuum pull on the power piston and the tapered tip of the primary metering rod moves upward in the main metering jet orifice. The smaller diameter of the metering rod tip allows more fuel to pass through the main metering jet and enrich the fuel mixture to meet the added power requirements. As engine load decreases, the manifold vacuum rises and extra mixture enrichment is no longer needed. The higher vacuum pulls downward on the power piston against spring force which moves the larger diameter of the metering rod into the metering

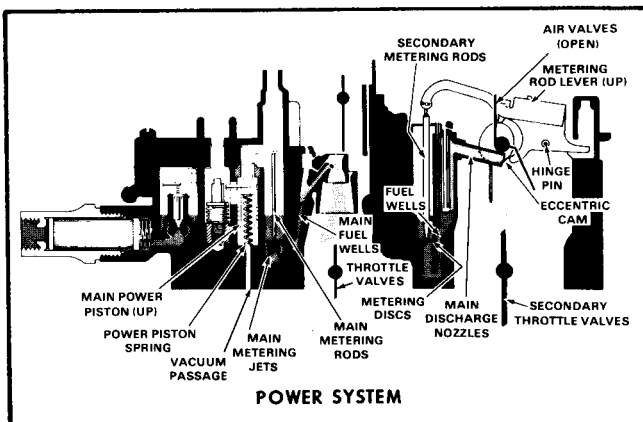

Figure 19 Power System

jet orifice returning the fuel mixture to normal economy ranges.

Dual power piston springs are used beneath the power piston in the piston bore of some 4MV-4MC Quadrajets models (Figure 19). A smaller diameter power piston spring seats in the center of the piston and bottoms on the float bowl casting. The spring is used to control power enrichment during light engine loads. A larger diameter spring surrounds the smaller inner spring and exerts additional pressure on the bottom of the power piston to provide efficient mixture ratios at heavier engine load conditions. The dual power piston spring feature, on models so equipped, assists in providing improved fuel control of air/fuel mixture ratios to meet emission and power requirements of the engine.

## POWER SYSTEM - MECHANICAL OPERATION

Some Quadrajets have a mechanical power enrichment system in addition to the vacuum enrichment feature. This provides accurate control of fuel mixtures at high engine speeds and load and yet allows the use of vacuum enrichment for improved fuel control during medium engine loads.

The mechanical enrichment is controlled by a stem pressed into the base of the power piston which extends into the throttle body. The stem is operated by a lever which is hinged to the throttle body casting and a cam on the center of the throttle shaft. When the throttle valves are opened to a pre-determined point, the cam on the throttle shaft forces the lever upward until it contacts the stem on the power piston and pushes the complete piston assembly upward against engine vacuum (Figure 20). This, in turn, lifts the metering rods, placing the smaller diameter of the metering rods in the main metering jets for positive mixture enrichment at greater throttle valve openings.

The power piston has a "trapped" spring which limits the travel of the piston during vacuum operation. The spring is retained between the piston and a fluted

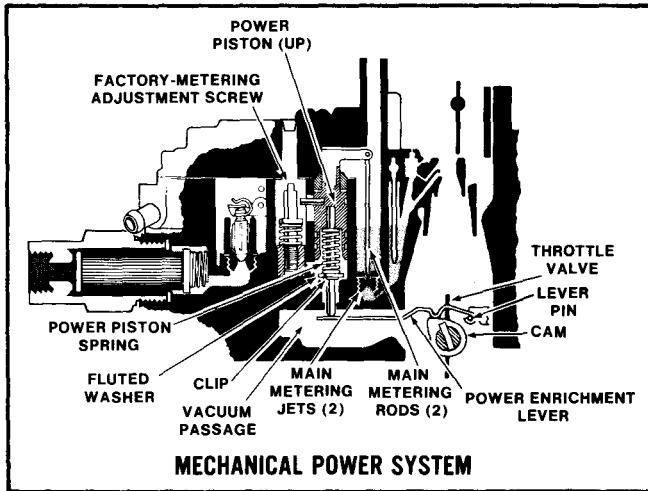

Figure 20 Mechanical Power Enrichment

washer on the power piston stem. The washer is retained with a "C" clip located in a groove on the power piston stem.

During high engine vacuum, the power piston spring is compressed and the fluted washer and piston are seated at the bottom of the power piston cavity. As engine load increases, vacuum drops and the power piston moves upward against spring tension until the "C" clip seats against the fluted washer. No more enrichment will take place until the pin in the power piston is contacted by the mechanical enrichment lever. As the throttle valves are opened further, the complete power piston assembly is forced upward placing the smaller diameter of the metering rods in the jets for maximum enrichment at higher engine speeds and loads.

When engine load and speed is decreased, the power piston will return to the down position, seating the fluted washer and piston in the bottom of the power piston cavity as high engine vacuum compresses the power piston spring. This returns the metering system to leaner fuel mixtures for light engine loads.

## MULTIPLE STAGE POWER ENRICHMENT

In some "modified" Quadrajets carburetors, a multiple stage power enrichment system, consisting of two power pistons (Figure 21), is used for more sensitive control of air/fuel ratios during light duty engine power requirements while providing for richer mixtures during moderate to heavy engine loads.

### AUXILIARY POWER PISTON

An auxiliary power piston and single metering rod assembly, located in front of the main (primary) power piston, is used for light duty power requirements. On light throttle opening when manifold vacuum drops to a predetermined point, the spring force under the auxiliary piston overcomes the vacuum pull and raises the piston

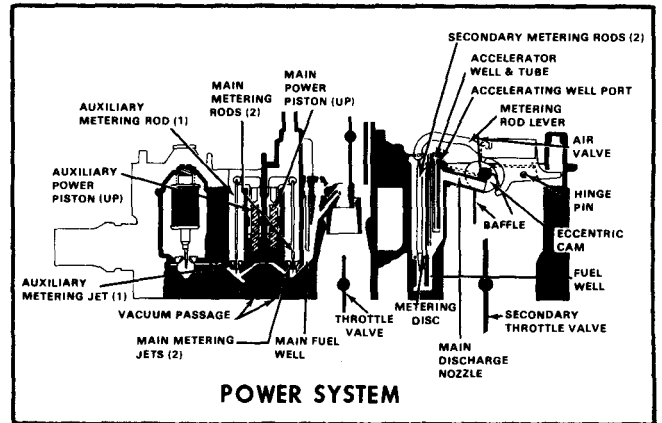

Figure 21 Multiple Stage Power System

which lifts the single metering rod out of a fixed metering jet. This provides partial fuel enrichment for light duty engine loads.

### MAIN (PRIMARY) POWER PISTON

During moderate to heavy engine loads when a further drop in manifold vacuum occurs with increased throttle opening, the main (rear) piston spring force overcomes the vacuum pull and raises the piston which lifts the two metering rods out of the metering jets for additional fuel enrichment for heavy duty power requirements.

The multiple stage (two piston) power enrichment system is specifically calibrated for the power requirements of each engine by controlling spring rates of each piston. The system requires no adjustment in the field; however, the main (rear) power piston and metering rod assemblies and the auxiliary (front) power piston and metering rod assembly are removable for normal cleaning and service replacement as needed.

**NOTICE:** The main (rear) and auxiliary (front) power piston springs must NOT be interchanged. To prevent mixing of power piston springs at time of carburetor disassembly, lightly wrap a piece of masking tape around the auxiliary power piston spring for identification. Then, on reassembly, remove the tape and install the spring in the front location beneath the auxiliary power piston with single metering rod.

### POWER SYSTEM - TURBOCHARGER APPLICATIONS

Some modified Quadrajets models are designed for Turbocharger applications. The power system in these models operates in the same manner as previously described except for one important difference. The vacuum supply, directed to the underside of the power piston, is controlled externally by a Turbocharger Vacu-

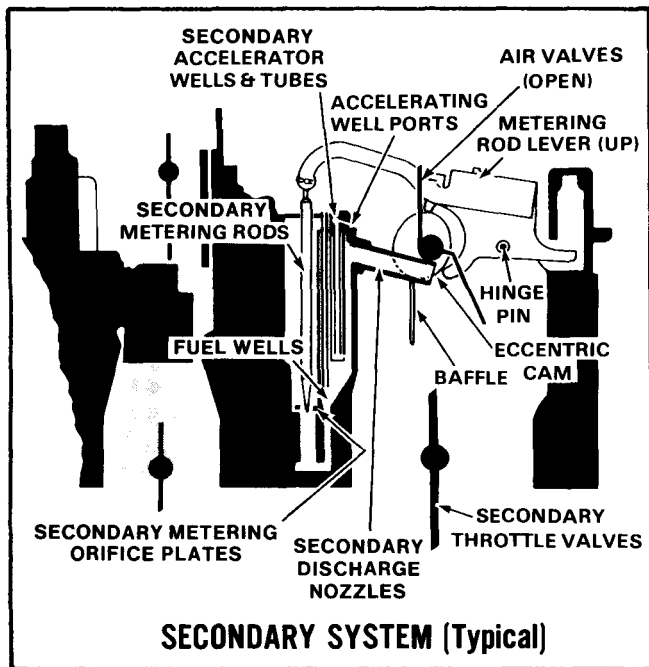

Figure 22 Secondary System - Typical

to meet engine demands. The secondary stage of the carburetor provides the additional air and fuel through the secondary throttle bores for power and performance requirements.

The secondary stage has a separate and independent metering system (Figure 22). It consists of two large throttle valves connected by a shaft and linkage to the primary throttle shaft. Fuel metering is controlled by a spring-loaded air valve, secondary metering orifice plates, secondary metering rods, fuel wells with bleed tubes, fuel discharge nozzles, accelerating wells and tubes. These are used to modify fuel flow characteristics for exact air/fuel calibration.

The secondary metering system supplements fuel flow from the primary stage and operates as follows:

When the engine reaches a point where the primary bores cannot meet engine air and fuel demands, a lever on the primary throttle shaft, through a connecting link to the pick-up lever on the secondary throttle shaft, begins to open the secondary throttle valves. This occurs only if the choke has warmed the thermostatic coil sufficiently to release the secondary throttle valve lock-out lever (if used).

As the secondary throttle valves open, engine manifold vacuum (low pressure) is applied directly beneath the air valves. Atmospheric pressure on the top of the air valves forces the air valves open against spring and air valve dashpot forces, provided the choke coil has warmed sufficiently to release the air valve lockout lever, if used. This allows air to pass through the secondary bores of the carburetor.

On most models, accelerating wells are used to supply fuel immediately to the secondary bores. This prevents a momentary leanness until fuel begins to feed from the secondary discharge nozzles. When the air valves begin to open, the upper edge of each valve passes the accelerating well ports (one for each bore). As the edges of the air valves pass the ports, they are exposed to manifold vacuum and immediately feed fuel from the accelerating wells located on each side of the fuel chamber. Each accelerating well has a calibrated orifice which meters the fuel supplied to the well from the fuel chamber. Some models have the accelerating well ports located beneath the front edge of the air valve instead of above. These begin to feed fuel to the secondary bores almost instantly after the secondary throttle valves open and before the air valves begin to open. This type of porting is used on some models where added enrichment is needed during cold operation when the air valve is locked closed, and also provides an earlier cut-in of fuel from the ports than the models which have the port located above the valves. The use of either type of porting is dependent upon engine fuel demands.

um Bleed Valve. The vacuum signal is routed to the carburetor through a hose from the bleed valve to an external tube located on the side of the carburetor.

The power system operates as follows:

During part throttle and cruising ranges, engine load is light and vacuum, from the Turbocharger Vacuum Bleed Valve, is sufficient to hold the power piston down against spring force and the larger diameter of the metering rod tip is held in the metering jet for leaner mixtures.

As engine load is increased to a point where extra fuel enrichment is required and the intake manifold is pressurized by the exhaust gas driven Turbocharger, the vacuum bleed valve "switches" and reduces vacuum to the power piston to zero. At this point, spring force operating on the power piston lifts the main metering rods for increased fuel delivery.

The remote power enrichment feature, through the vacuum bleed valve, provides richer mixtures during heavy engine loads and wide-open throttle power requirements when the intake manifold is pressurized by the Turbocharger at a time when manifold vacuum is high enough tending to operate the power piston in the normally "lean" position. In this way, the power system controls fuel metering during light and heavy power requirements.

## SECONDARY SYSTEM

The primary stage of the Quadrajets carburetor provides adequate air and fuel for low speed operation. However, at higher speed, more air and fuel are needed

The secondary main discharge nozzles (one for each bore) are located just below the center of the air valves



and above the secondary throttle valves. The nozzles, being located in a low pressure area, feed fuel as follows:

As the secondary throttle valves are opened, atmospheric pressure opens the air valves. This rotates a plastic eccentric cam attached to the center of the air valve shaft. As the cam rotates, it lifts the secondary metering rods out of the secondary orifice plates through the metering rod hanger which follows rotation of the eccentric cam.

Fuel flows from the fuel chamber through the secondary metering orifice plates into the secondary main wells where it is mixed with air from the secondary main well air bleed tubes. The air emulsified fuel mixture travels from the main wells through the secondary discharge nozzles where it sprays into the secondary bores. Here the fuel is mixed with air traveling through the secondary bores to supplement the air/fuel mixture delivered from the primary bores and goes on into the engine as a combustible mixture.

As the secondary throttle valves are opened further and engine speeds increase, air flow through the secondary side increases and opens the air valves to a greater degree which, in turn, lifts the secondary metering rods further out of the orifice plates. The metering rods are tapered so that the fuel flow through the secondary metering orifice plates is directly proportional to air flow through the secondary carburetor bores. In this manner, correct air/fuel mixtures through the secondary bores are controlled by the depth of the metering rods in the orifice plates.

The depth of the metering rods in the orifice plates in relation to the air valve position are factory adjusted to meet air/fuel requirements for each specific engine model — no change in this adjustment should be made in the field. Also, many models include a tang on the air valve lever which contacts a stop on the air horn casting to control carburetor air flow capacity.

## METERING RODS - PRIMARY

There are two types of primary main metering rods used in the Quadrajets carburetors. 1968 and later models use a rod which has a double or multiple taper at the metering tip. The 1967 and earlier models have a single taper at the metering tip.

Both rod types use a similar two-digit numbering system. The number indicates the diameter of the metering rod and is the last two digits of the part number. The 1968 and later models will have a letter stamped on the rod after the two-digit number.

## METERING RODS - SECONDARY

The secondary rods are coded with a two-letter system which corresponds directly to the part number.

(See Delco Bulletin 9A-100 for a complete description and listing of metering rods).

There are other features incorporated in the secondary metering system as follows:

1. The secondary main well air bleed tubes extend downward into the main fuel well below normal fuel level. These bleed air into the fuel in the secondary wells to quickly emulsify the fuel with air for good atomization and improved fuel flow from the secondary nozzles.

2. The secondary metering rods may have a milled slot at the larger diameter of the metering tip. The purpose of the slots is to ensure an adequate supply of fuel in the secondary main wells when the air valves are in the closed position. At this point, the metering rods are nearly seated against the metering orifice plates. The slot in the rod is adjacent to the orifice plate and allows a small amount of fuel to pass between the metering rod and metering disc. During extreme hot engine idle or hot soak, the fuel could boil out of the secondary fuel wells. The milled slot allows enough fuel to bypass the orifice plate and keep the main fuel wells full of fuel. This ensures adequate fuel supply in the main wells at all times to give immediate fuel delivery from the secondary discharge nozzles.

3. Some applications use secondary discharge nozzles that incorporate a vertically drilled cross hole located about half way down the length of the nozzle. The hole serves as an additional air bleed to assist air/fuel mixture distribution passing through the secondary discharge nozzle.

4. A baffle plate, extending into each secondary bore, is located just below the air valves on all models. The baffle extends up and around the secondary discharge nozzles to provide equal fuel distribution, as near as possible, to all engine cylinders at lower air flows.

5. On some models, an integral baffle is added to the bottom side of the secondary air valve. The baffle improves mixture distribution from the secondary side at higher air flows.

6. An air horn baffle is used on some models to prevent incoming air from the air cleaner reacting on the secondary main well bleed tubes. The baffle is located adjacent to the secondary well bleed tubes and extends above the air horn between the primary and secondary bores. This prevents incoming air from forcing the fuel level down in the secondary wells through the bleed tubes and prevents secondary nozzle lag on heavy acceleration.

7. Some models use notched secondary air valves to reduce the vacuum signal at the nozzles for leaner air/fuel mixture ratios during initial air valve opening. The leaner mixtures assist in meeting emission requirements and also improve throttle response when operating at high altitudes.

## AIR VALVE DASHPOT

The secondary air valves use an air valve dashpot

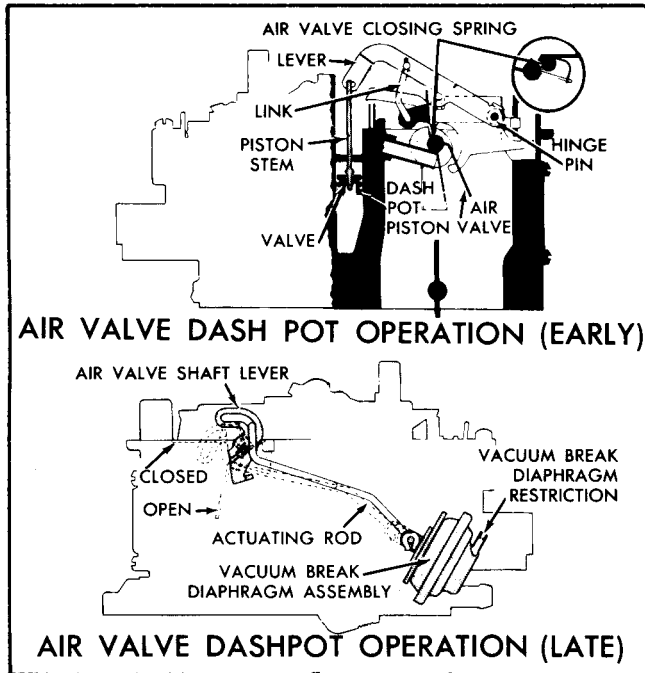

Figure 23 Air Valve Dashpot Designs

feature to control opening rate of the air valve. This prevents an uncontrolled air valve opening rate which results in an instantaneous air rate change and a "lagging" fuel rate change as the secondary throttle valves are opened. The dashpot, through linkage, controls opening of the air valves to provide a smooth transition to secondary system operation.

There are two different types of air valve dashpots used in the Quadrajet carburetor:

The early type dashpot (Top of picture, Figure 23) consists of a piston which operates in a fuel well adjacent to the float bowl. The piston stem is connected to the air valve through a link and lever assembly. As the air valves open, the dashpot piston is pulled upward forcing fuel to flow between the side of the piston and fuel well which retards the air valve opening. A rubber washer attached to the piston stem acts as a check valve. During upward movement of the piston, the rubber washer seats and forces all fuel to flow around the piston. When the air valve closes, the check valve unseats and allows fuel to also pass through the center of the piston allowing the air valves to return closed rapidly.

The late type air valve dashpot (Lower picture, Figure 23) operates off of the front choke vacuum break diaphragm unit. The secondary air valve is connected to the choke vacuum break unit by a rod, to control the opening rate of the air valve. Whenever manifold vacuum is sufficiently high, the vacuum diaphragm is seated, plunger retracted, against spring load. At this point, the vacuum diaphragm link is in the forward end of the slot in the air valve lever, or in the rear of the slot in the vacuum diaphragm plunger, and the air valves are closed.

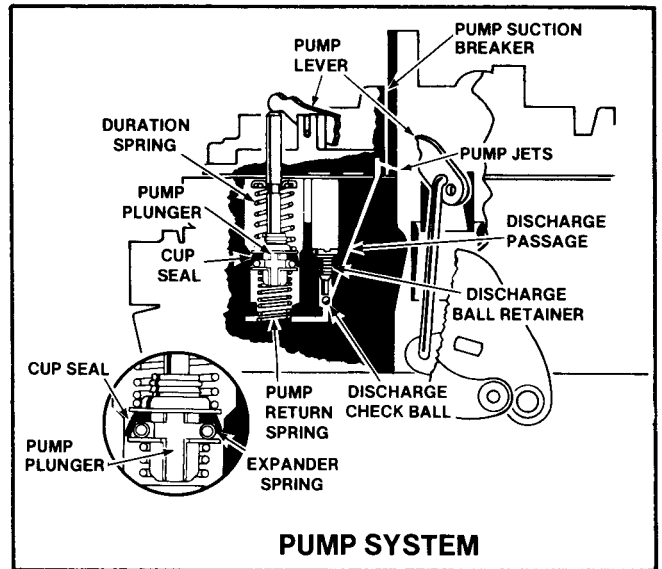

Figure 24 Pump System

During acceleration or heavy engine loads when the secondary throttle valves are opened, the manifold vacuum drops. The spring located in the vacuum diaphragm unit overcomes the vacuum force and moves the plunger stem outward. This action allows the air valves to open. The opening rate of the air valves is controlled by the calibrated restriction in the vacuum inlet of the diaphragm cover and the valve closing spring. The dashpot action, due to this restricted vacuum flow and spring force, provides the required delay in air valve opening needed until sufficient fuel flows from the secondary discharge nozzles.

## ACCELERATING PUMP SYSTEM

During quick accelerations when the throttle is opened rapidly, air flow through the carburetor bores and intake manifold vacuum change almost instantaneously. However, the fuel which is heavier, tends to lag behind causing a momentary leanness. To prevent this, the accelerator pump system is used to provide the extra fuel necessary for a smooth transition in engine operation during this period.

The accelerating pump system is located in the primary stage of the carburetor. It consists of a spring-loaded pump plunger and pump return spring (operating in a fuel well), fuel passage, discharge check ball, retainer, and pump jets, one in each bore (Figure 24).

On most late Quadrajet models, an expander (garter) spring is used in the pump cup for constant pump cup to pump wall contact. The pump cup is of the floating design; i.e., the up and down movement of the cup on the plunger head either "seats" to provide a solid charge of fuel on the down-stroke, or "unseats" on the filling of the pump well (up-stroke). The cup remains unseated when there is no pump plunger movement which allows vapor to vent from the pump well.



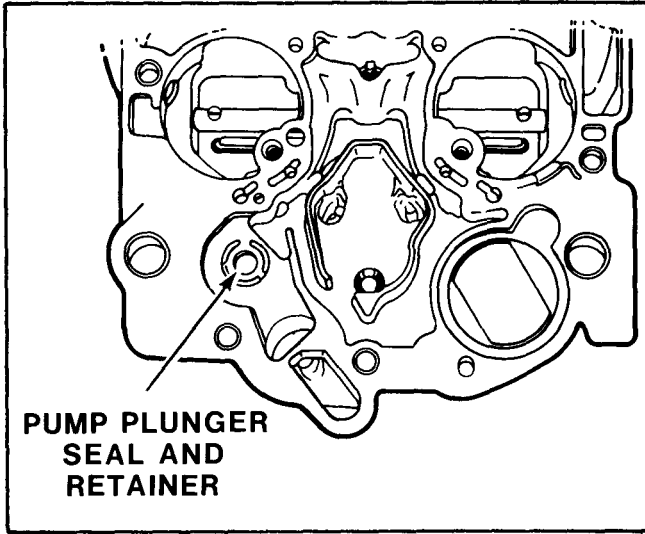

Figure 25 Pump Stem Seal & Retainer

The pump plunger is operated by a pump lever on the air horn which is connected directly to the throttle lever by a rod.

When the pump plunger moves upward in the pump well as happens during throttle closing, fuel from the fuel chamber enters the pump well through a vertical slot located near the top of the pump well. It flows past the "unseated" pump cup to fill the bottom of the pump well and pump discharge passage.

When the primary throttle valves are opened, the pump rod and lever forces the pump plunger downward. The pump cup seats instantly and fuel is forced through the pump discharge passage where it unseats the pump discharge check ball and passes on through the passage to the pump jets where it sprays into the venturi area of each primary bore.

It should be noted the pump plunger is spring loaded. The upper duration spring is balanced with the bottom pump return spring so that a smooth, sustained charge of fuel is delivered during acceleration. Selection of the duration spring by the factory is used to control the differences in rate of movement between the pump linkage and the plunger head for correct pump fuel delivery.

The pump discharge check ball seats in the pump discharge passage during upward motion of the pump plunger so that air will not be drawn into the passage and prevent proper pump fill.

During higher air flows through the primary bores, a vacuum exists at the pump jets. A passage, located just behind the pump jets, leads to the top of the air horn to vent the pump fuel circuit outside the carburetor bores. This acts as a suction breaker so that when the pump is not in operation, fuel will not be pulled out of the pump jets into the venturi area. This insures a full pump stream when needed and prevents any fuel "pull-over" from the pump discharge passage.

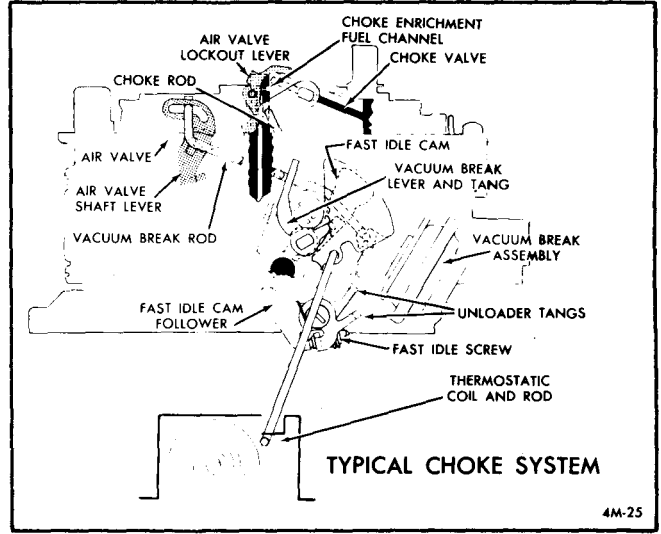

Figure 26 Choke System-4MV

In order to keep evaporative emission levels to a minimum, later model M4ME-M4MC models have a pump plunger stem seal and retainer located in the air horn. In the event of service repair or cleaning of the carburetor, a new seal and retainer should be installed (See Figure 25).

## CHOKE SYSTEM

The Quadrajets choke valve is mounted in the air horn located above the carburetor primary venturi. A closed choke valve provides the correct air/fuel mixture enrichment to the engine for good cold engine starting and when partially open smooth running during the warm-up period. The secondary throttle valves, or air valve on some models, are locked closed until the engine is thoroughly warm and the choke valve is wide open.

The Model 4MV choke system (Figure 26) consists of a choke valve, vacuum break diaphragm assembly, thermostatic coil-mounted on the intake or exhaust manifold, fast idle cam, and connecting linkage.

Heat from exhaust gases is used for control of thermostatic coil temperature. Choke operation is controlled by a combination of intake manifold vacuum, the off-set choke valve, temperature, and throttle position.

The thermostatic coil is calibrated to hold the choke valve closed when the engine is cold.

The choke system operates as follows:

When the engine is cold, prior to starting, depressing the accelerator pedal to the floor opens the carburetor throttle valves. This allows the fast idle cam follower lever to clear the steps on the fast idle cam. At this point, torque from the thermostatic coil closes the choke valve and rotates the fast idle cam so that the cam follower lever comes to rest on the highest step of the fast idle cam. (This opening of the throttle valves also



pumps a priming mist of fuel through the pump jets into the primary throttle bores to aid starting). During cranking, engine vacuum below the choke valve pulls fuel from the idle system and main discharge nozzles. This provides adequate enrichment for good cold starts.

Some Quadrajets models use a choke enrichment fuel system to supplement fuel feed from the primary main discharge nozzles for good cold engine starting.

Two calibrated holes, one in each primary bore, are located in the air horn just **BELOW** the choke valve to supply added fuel for cold enrichment during the cranking period. The extra fuel is supplied through channels which lead to the secondary accelerating well pickup tubes to allow fuel at closed choke to be drawn from the secondary accelerating wells located in the float bowl chamber, (As shown in Figure 26). Also, during warm engine operation, the two calibrated holes in the air horn feed a small metered amount of fuel at higher air flows to supplement fuel flow in the primary bores to provide the extra fuel needed at higher engine speeds.

As mentioned earlier (See Main Metering System), other Quadrajets models use the fuel pull-over enrichment system. This system is similar to the choke enrichment fuel system except that two calibrated holes, one in each primary bore, are located in the air horn just **ABOVE** the choke valve to supply added fuel during higher carburetor air flows. The calibrated holes, located above the choke valve, do not feed fuel at closed choke during the engine cranking period.

When the engine starts and is running, manifold vacuum is applied to the vacuum break diaphragm unit mounted on the side of the float bowl. This moves the diaphragm plunger in until it strikes the rear cover, thereby opening the choke valve to a point where the engine will run without loading or stalling. (This is called the "vacuum break" position). At the same time, the fast idle cam follower lever on the end of the primary throttle shaft will drop from the highest step on the fast idle cam to a lower step when the throttle is opened. This gives the engine sufficient fast idle and correct fuel mixture for running until the engine begins to warm up and heat the thermostatic coil.

As the engine continues to warm up, heat gradually relaxes tension of the thermostatic coil to allow the choke valve to continue opening through air pressure pushing on the offset choke valve and the weight of the linkage pulling the choke valve fully open at which point the engine can run at normal air/fuel mixtures.

The fast idle cam has graduated steps so that the fast idle speed is lowered gradually during the engine warm-up period. The fast idle cam movement (and step position) is a function of choke valve position. When the engine is warm and the choke valve is completely open, the fast idle cam follower will be off the steps of the fast idle cam. At this point, the idle speed screw or solenoid controls normal (warm) engine idle speeds.

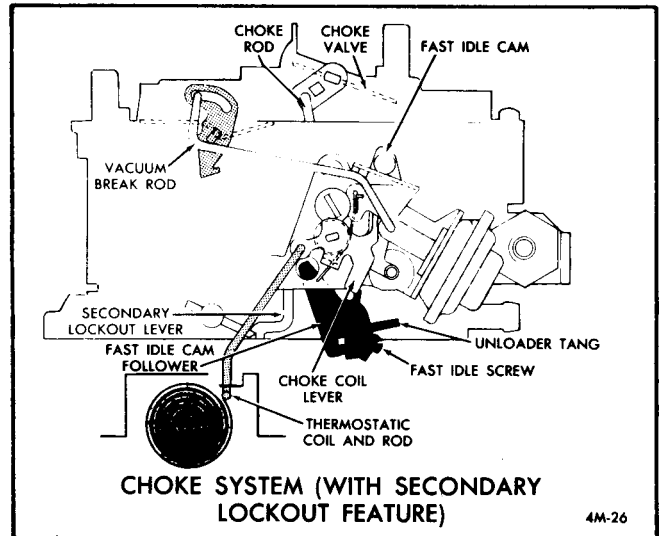

Figure 27 Secondary Throttle Valve Lockout

## SECONDARY THROTTLE VALVE LOCKOUT

A secondary throttle valve lockout feature is used on many Quadrajets models to prevent opening of the secondary throttle valves during cold operation when wide-open accelerations could cause possible engine damage or excessive wear (Figure 27). On these applications, a lockout lever, located on the float bowl, is weighted so that a tang on the lower end of the lever catches a lock pin on the secondary throttle shaft and keeps the secondary throttle valves closed. As the engine warms up, the choke valve opens and the fast idle cam drops. When the engine is thoroughly warm, the choke valve is wide open and the choke coil pulls the intermediate choke lever completely down and the fast idle cam drops down so that the cam follower is completely off the steps of the cam. As the cam drops the last few degrees, it strikes the secondary lockout lever and pushes it away from the secondary valve lockout pin. This allows the secondary throttle valves to open and operate as described under the Power System.

## AIR VALVE LOCKOUT

Some Quadrajets carburetors incorporate an air valve lockout feature (Figure 28), instead of the secondary throttle valve lockout, whereby the air valves are locked closed until the engine is thoroughly warm and the choke valve is wide open. An air valve lockout lever, mounted on the air horn, is so weighted that a tang on the lever catches the upper edge of the air valve and keeps the air valves closed when the choke valve is closed. When the thermostatic coil warms up it moves the choke valve toward the open position, the end of the choke rod moves upward and strikes a tang on the air valve lockout lever. As the choke rod moves up to the end of its travel, it pushes the lockout tang upward and unlocks the air valve.

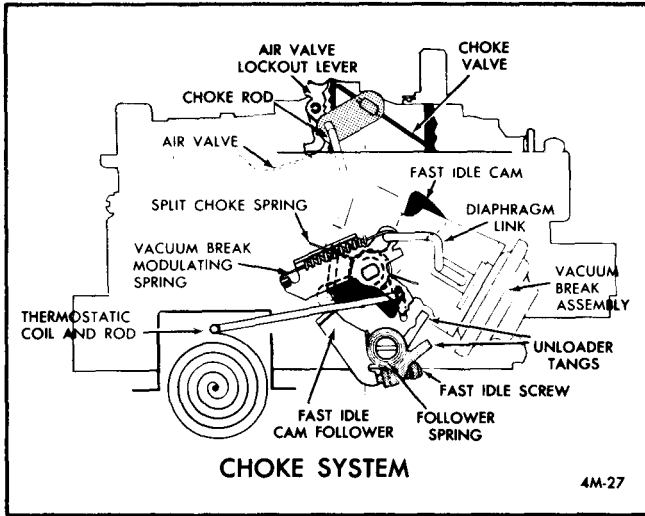

Figure 28 Air Valve Lockout

Also, some early model 4MV carburetors use a vacuum break modulating spring and split choke spring (Figure 28). The vacuum break modulating spring allows the vacuum break (choke valve position) to vary according to ambient temperature. The vacuum break modulating spring, connected to the vacuum break link, allows varying choke openings depending on the closing force of the thermostatic coil. As the closing force of the coil increases (cool weather), the link is allowed to move in the slotted lever until the modulating spring overcomes the coil force, or the link is in the end of the slot. This results in less vacuum break during cooler weather and more vacuum break during warmer weather.

The split choke feature operates during the last few degrees of choke thermostat rotation. The purpose is to maintain the fast idle speed long enough to keep the engine from stalling, but allow the use of a choke coil which lets the choke valve open quickly. The operation of the split choke feature is controlled by a torsion spring on the intermediate choke lever shaft. As explained earlier, air pressure action on the offset choke valve tends to force the choke valve open against tension of the choke thermostatic coil. In the last few degrees of thermostatic coil opening motion, a tang on the intermediate choke lever contacts the end of the torsion spring. This keeps the fast idle cam follower lever on the last step of the fast idle cam longer to maintain fast idle until the engine is thoroughly warm. The spring works against the thermostatic coil until the coil is hot enough to pull on the intermediate choke lever and overcome the torsion spring tension. The torsion spring must be placed in the specified notch in the vacuum break mounting bracket for application used.

On all 4MV models, the choke system is equipped with an unloader mechanism which is designed to partially open the choke valve, should the engine become loaded or flooded. To unload the engine, the accelerator pedal must be depressed so that the throttle valves are held wide open. A tang on a lever on the choke side of

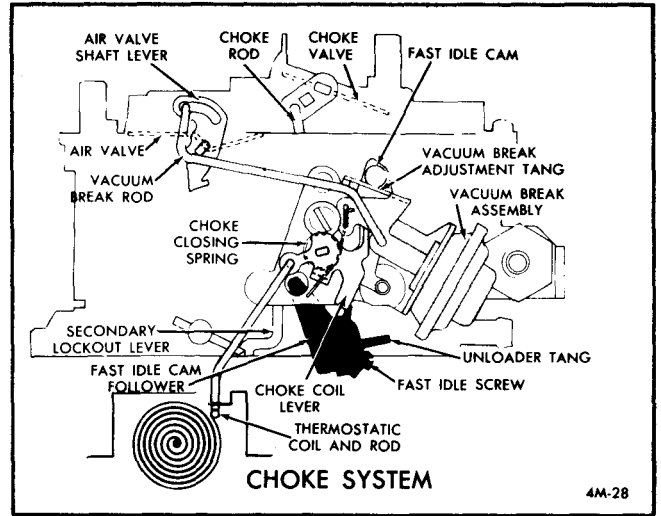

Figure 29 Spring Assist Choke Closing System

the primary throttle shaft contacts the fast idle cam and through the intermediate choke shaft forces the choke valve slightly open. This allows extra air to enter the carburetor bores and pass on into the engine manifold and cylinders to lean out the fuel mixture so that the engine will start.

### CHOKE SYSTEM WITH SPRING ASSIST CHOKE CLOSING SYSTEM

Some 4MV carburetors use a spring assist choke closing system (Figure 29). The assist spring is of the torsion type and is added to the intermediate choke shaft. It exerts pressure on the vacuum break lever to force the choke valve toward the closed choke position. The tension of the torsion spring is overcome by the choke thermostatic coil located on the engine manifold which, during the engine warm up period, will pull the choke valve open. The addition of a torsion spring assists in closing the choke valve to ensure good engine starting when the engine is cold.

Along with the choke closing assist spring, certain 4MV models use the fast idle cam "pull-off" feature.

When the engine starts and is running, manifold vacuum is applied to the vacuum break diaphragm and the diaphragm plunger moves slowly inward to open the choke valve. As this happens, a tang on the plunger contacts the end or "tail" of the fast idle cam to "pull-off" the cam from the high step to the lower second step setting.

A slight change in the method of vacuum break adjustment is required on these models that use the fast idle cam "pull-off" feature. (See Adjustment Procedures in the 9D-5 Section of the Delco Carburetor Parts and Service Manual 9X).

### CHOKE SYSTEM WITH VACUUM BREAK CLOSING ASSIST SPRING

Other 4MV models have the choke closing assist

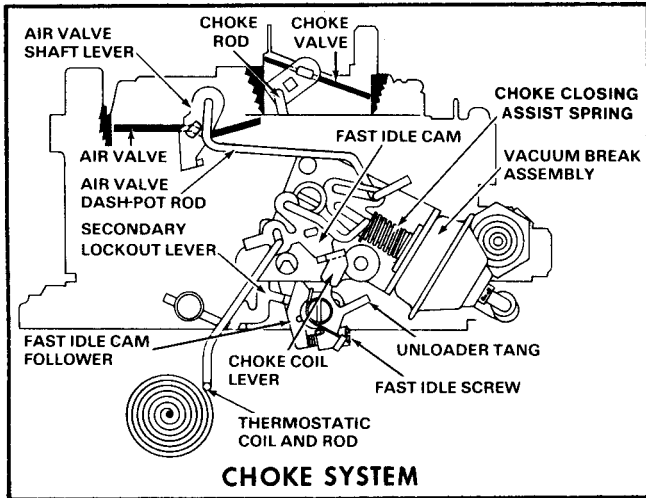

Figure 30 Vacuum Break Closing Assist Spring

spring located on the vacuum break plunger stem replacing the torsion spring located on the intermediate choke shaft (Figure 30).

The choke closing assist spring aids in closing the choke valve along with tension from the remote choke thermostatic coil for improved engine starting. The choke closing assist spring only exerts pressure on the vacuum break link to assist in closing the choke valve during engine starting. When the engine starts and the choke vacuum break diaphragm seats, the closing spring retainer hits a stop on the plunger stem and the assist spring no longer exerts pressure on the choke valve.

The vacuum break diaphragm plunger is slotted to allow for free travel of the air valve dashpot link. The slot is moved from the air valve shaft lever to the vacuum break plunger. A change in air valve dashpot adjustment procedure is required. (See Adjustment Procedures in the 9D-5 Section, Delco Carburetor Parts and Service Manual 9X).

## CHOKE SYSTEM WITH DELAYED VACUUM BREAK FEATURE

To delay the choke valve from opening too fast, some 4MV models use a delayed vacuum break system. An internal delay valve is included inside the diaphragm unit (Figure 31).

The delay feature operates as follows:

When the engine starts, vacuum acting on the internal delay valve bleeds air through a small hole in the valve which allows the vacuum diaphragm plunger to move slowly inward. This gives sufficient time to overcome engine friction and wet the engine manifold to prevent a lean stall. When the vacuum break diaphragm is fully seated, which takes a few seconds, the choke valve will remain in the vacuum break position until the engine begins to warm and relax the thermostatic coil located on the exhaust crossover in the intake manifold.

In addition to the internal delay valve, some car

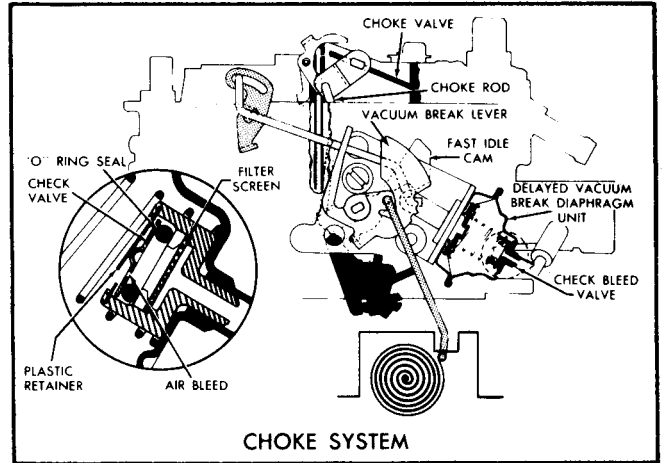

Figure 31 Delayed Vacuum Break Feature

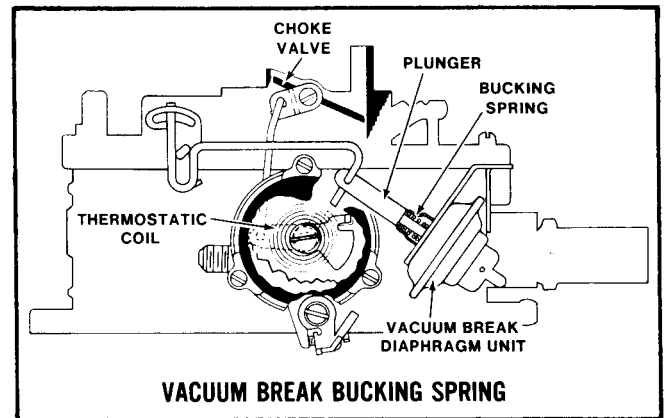

Figure 32 Vacuum Break Bucking Spring

applications have a separate vacuum delay tank added to the system. This is connected "in series" to a second vacuum tube on the vacuum diaphragm unit to further delay the choke vacuum break diaphragm operation.

The delay valve in the choke vacuum diaphragm unit is designed to "pop" off its seat and allow the diaphragm plunger to extend outward, when the spring force against the diaphragm is greater than the vacuum pull. This will give added enrichment as needed on heavy acceleration during cold drive-a-way by allowing the choke coil to slightly close the choke valve. Some 4MV models use a calibrated restriction in the vacuum inlet to the vacuum break diaphragm unit in place of the internal delay valve. Similar to the internal delay valve, the calibrated restriction delays the supply of vacuum to the diaphragm unit to retard opening of the choke valve for good engine starting.

## CHOKE SYSTEM WITH VACUUM BUCKING SPRING

A spring-loaded plunger is used in the vacuum break unit on some 4MV models (Figure 32). The purpose of the spring, called a "bucking spring", is to offset choke thermostatic coil tension and balance the opening of the choke valve with tension of the choke coil. This



enables further refinement of air/fuel mixtures because the coil, which senses engine and ambient temperatures, will allow the choke valve to open gradually against spring tension in the diaphragm plunger head. In other words, in very cold temperatures, the extra tension created by the thermostatic coil will overcome the tension of the diaphragm plunger (bucking) spring to provide less choke valve opening with the result of slightly richer mixtures. In warmer temperatures, the thermostatic coil will have less tension and, consequently, will not compress the spring as much thereby giving a greater choke valve opening for slightly leaner mixtures.

### CHOKE SYSTEM WITH DUAL DELAYED VACUUM BREAK SYSTEM

Other Quadrajets carburetors use a dual delayed vacuum break system consisting of front and rear vacuum break diaphragm units (Figure 33).

The dual delayed vacuum break system operates as follows:

During engine cranking, the choke valve is held closed by the tension of the thermostatic coil. This restricts air flow through the carburetor to provide a richer starting mixture.

When the engine starts and is running, manifold vacuum is applied to both vacuum break units which are mounted on the side of the float bowl. The front (primary) vacuum break diaphragm opens the choke valve to a point where the engine will run without loading or stalling. As the engine is wetted and friction decreases after start, a delay valve in the rear (auxiliary) vacuum break unit causes a delayed action to gradually open the choke valve a little further until the engine will run at a slightly leaner mixture to prevent loading.

A plunger "bucking spring" may be included on the diaphragm plunger of the rear diaphragm unit (See explanation, plunger bucking spring operation).

A clean air purge feature is added to the rear vacuum break diaphragm unit on some 4MV models using the dual delayed vacuum break system (Figure 33). A clean air bleed, added to the tube at the rear of the rear vacuum break unit and located beneath a rubber covered filter, purges the system of any fuel vapors and dirt which possibly may enter the internal delay valve to disrupt operation. A change in adjustment procedure for setting the rear vacuum break is required on those models using the clean air purge feature. (See Adjustment Procedures, Section 5, of the Delco Carburetor Parts and Service Manual 9X).

### CHOKE SYSTEM - 4MC (EARLY)

The model 4MC carburetor differs from the 4MV model in that the thermostatic choke coil is located in a choke housing, mounted directly to the side of the carburetor float bowl, instead of a "remote choke" coil mounted on the intake or exhaust manifold.

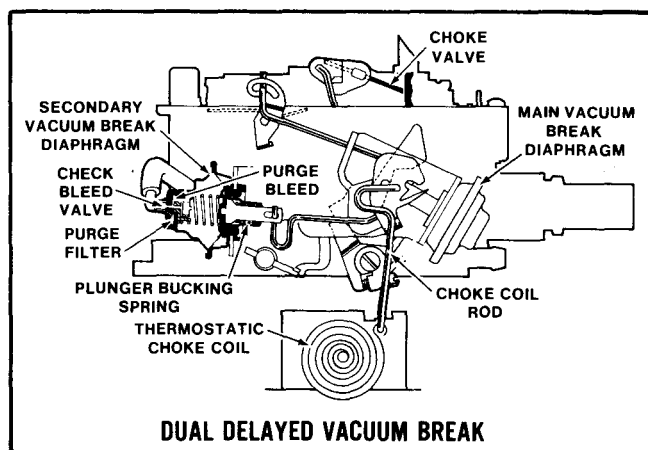

Figure 33 Dual Delayed Vacuum Break System

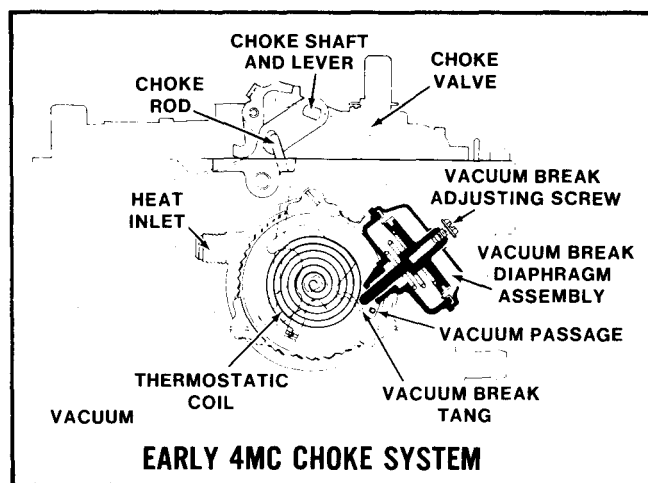

Figure 34 Early 4MC Choke System

On 4MC models, engine vacuum is supplied through an orifice in the choke housing which pulls heat from the manifold heat stove into the choke housing and heat gradually relaxes choke coil tension. This allows the choke valve to continue opening through inlet air pressure pushing on the offset choke valve and the weight of the choke linkage pulling the valve open.

On early model 4MC carburetors (Figure 34), the vacuum break diaphragm is mounted integrally with the choke housing located on the float bowl. An adjustable plastic plunger is included as a part of the vacuum break diaphragm. During cold operation after the engine starts and is running, manifold vacuum applied to the vacuum diaphragm pulls the diaphragm inward and the plunger strikes the vacuum break tang inside the choke housing which, in turn, rotates the intermediate choke shaft and through connecting linkage opens the choke valve to the "vacuum break" position.

### CHOKE SYSTEM - 4MC (LATE)

The choke housing on later model 4MC carburetors

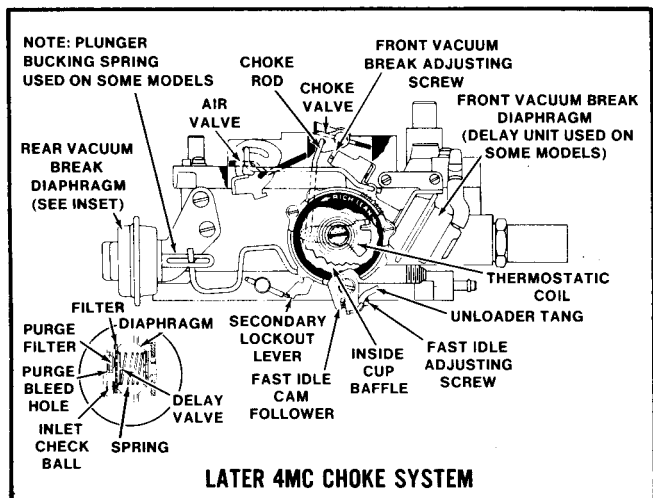

Figure 35 Later 4MC Choke System

(Figure 35) is also located on the float bowl, but with a separately mounted vacuum break diaphragm unit. The vacuum diaphragm unit on some 4MC models includes an internal delay valve for good control of choke mixtures during the engine warm-up period (see description of Delayed Vacuum Break System, Figure 31).

### CHOKE SYSTEM - M4MC-M4MCA

Similar to 4MC models, an integral choke housing and an exhaust heated air thermostatic coil assembly are mounted on the carburetor float bowl on M4MC-M4MCA models (Figure 36). A single or a dual vacuum break system is used for control of choke mixtures during the warm-up period. A special adjusting screw is included on the front vacuum break unit on all "modified" Quadrajets models. The vacuum break is adjusted by turning this screw to position a tang on the plunger that contacts the vacuum break lever.

On some models, the front and/or rear vacuum break units are delayed in operation by an internal delay valve (see inset, Figure 36). The valve delays opening of the choke valve a few seconds to allow the engine to run on richer mixtures.

A clean air purge feature is used in either the front and rear vacuum break diaphragm units or in the rear unit only, depending upon carburetor application, to prevent dirt from plugging the internal delay valve. A filter element is installed internally with a small bleed hole located in the end cover of the diaphragm unit. During engine operation, vacuum acting upon the diaphragm pulls a small amount of filtered air through the bleed hole in the end cover to purge the system of any fuel vapors or dirt contamination which might be pulled into the internal delay valve located inside the diaphragm unit. During adjustment of the front and rear vacuum breaks, it will be necessary to plug the end cover of the vacuum break unit with tape, making sure to seal the small bleed hole.

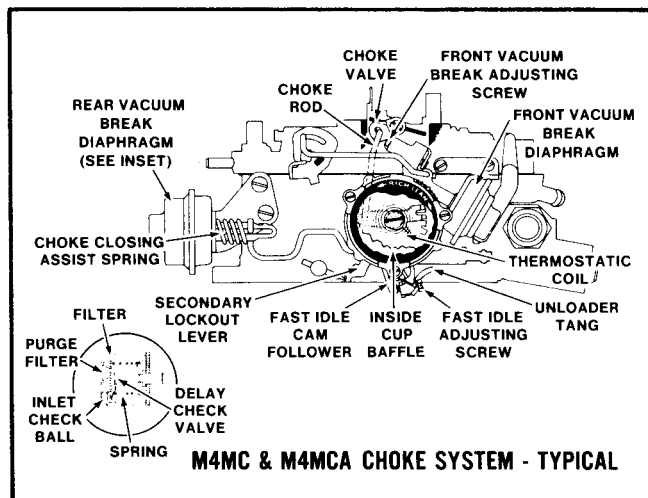

Figure 36 M4MC-M4MCA Choke System (Typical)

Also, a vacuum inlet check ball may be used in the vacuum inlet tube on the front and rear vacuum break units. The purpose of the inlet check ball is to prevent excess dirt and vapor contaminants from plugging the small internal delay valve in the diaphragm unit in case of engine "backfire" or "dieseling" conditions.

The rear vacuum break unit on some applications may include a tension (bucking) spring in the diaphragm plunger head. (See previous explanation Plunger Bucking Spring Operation Page 21).

On some M4MC-M4MCA models, the rear vacuum break unit includes a choke closing assist spring (See Figure 30 and previous explanation of closing assist spring operation Page 20).

Some M4MC-M4MCA models incorporate the "trapped stat" thermostatic coil design whereby the end of the thermostatic coil is installed in a slot in the coil pick-up lever inside the choke housing. In this way, the coil is kept in contact with the pick-up lever at all times for prompt response to choke coil tension.

### FAST IDLE CAM PULL-OFF FEATURE

A fast idle cam "pull-off" feature is included on some M4MC-M4MCA carburetor applications. Manifold vacuum to the rear vacuum break diaphragm is supplied through a water temperature controlled thermal vacuum switch (TVS) and by an electrically operated time delay solenoid.

During cold operation when manifold vacuum is applied through the TVS and the solenoid to the rear vacuum break diaphragm, the diaphragm plunger moves inward pulling on the vacuum break rod which rotates the vacuum break lever to "pull-off" the fast idle cam from the high step to the lower step setting. Thus, the cam "pull-off" feature prevents prolonged high idle speeds during the warm-up period.



is adjusted at the factory. No attempt should be made to adjust the Idle Load Compensator unless, in diagnosis, curb idle speed is not to factory specifications. If adjustment is necessary, refer to **Service Manual** for proper procedures

## MAJOR SERVICE OPERATIONS - ALL MODELS

### General

The procedures, below, apply to the complete overhaul with the carburetor removed from the engine. However, in many cases, service adjustments of individual systems may be completed without removing the carburetor from the engine.

A complete carburetor overhaul includes disassembly, thorough cleaning, inspection, replacement of all gaskets — diaphragms — seals — worn or damaged parts, and service adjustment of individual systems, plus restoring tamper resistant features where applicable.

### Disassembly, Cleaning, Inspection and Adjustments

The following disassembly and assembly procedures may vary somewhat between applications due to specific design features. However, they will pertain basically to all Quadrajets models.

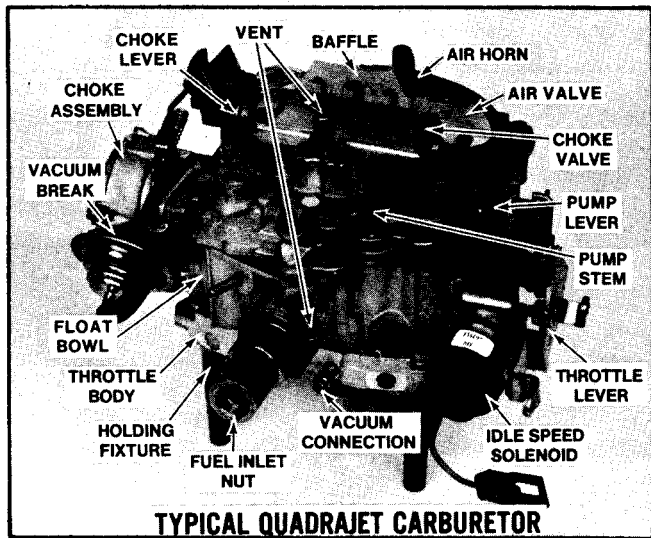

Figure 42 Typical Quadrajets Carburetor

### Disassembly

**NOTICE:** Before performing any service on the carburetor, it is essential that the carburetor be placed on a holding fixture such as BT-30-15. Without the use of the holding fixture, it is possible to bend or nick throttle valves.

### Idle Stop Solenoid Removal

1. Remove screw(s) securing the idle stop solenoid bracket to float bowl and remove solenoid and bracket assembly. On some applications, the solenoid and bracket assembly are an integral unit and serviced as a complete assembly. On some applications where the solenoid is mounted in the bracket as a separate unit, if solenoid replacement is necessary, bend back retaining tabs on lockwasher; then remove large idle stop solenoid retaining nut and remove solenoid from bracket.

**NOTICE:** Follow the above procedure to remove the A/C idle speed solenoid, throttle closing dashpot, or throttle lever actuator. The idle stop solenoid, A/C idle speed solenoid, throttle closing dashpot, or throttle lever actuator should not be immersed in any type of carburetor cleaner and should always be removed before complete carburetor overhaul.

2. On 4MV models using either a Combination Emission Control (C.E.C.) valve or idle stop solenoid mounted on the carburetor:

a) On C.E.C. models only, remove vacuum hose from the C.E.C. valve and vacuum tube on the float bowl.

b) Remove screw securing C.E.C. valve or idle stop solenoid bracket to float bowl.

**NOTICE:** Do not remove the bracket for the C.E.C. valve or idle stop solenoid from the air horn assembly unless replacement of the bracket is necessary. If necessary to replace the C.E.C. valve or idle stop solenoid, follow procedure noted under Step 1, above.

Do not immerse the C.E.C. valve assembly or idle stop solenoid in any type of carburetor cleaner.

### AIR HORN REMOVAL

1. If used, remove idle vent valve attaching screw; then remove idle vent valve assembly. If thermostatic vent valve is used, remove dust cover, then remove valve. Care should be used not to bend or distort the bi-metal strip.

2. On those 4MV models using the vacuum operated vent switch valve, remove small screw from top of vent valve plunger stem.

**NOTICE:** Hold plunger stem with needle-nosed pliers to prevent turning and tearing of diaphragm. Remove vent valve cover screw and air horn screw and carefully lift cover from air horn. Remove cover gasket, vent valve assembly, and spring, noting position of the vent valve for later reassembly. Remove diaphragm retainer and diaphragm from the air horn by carefully moving the diaphragm stem back and forth.



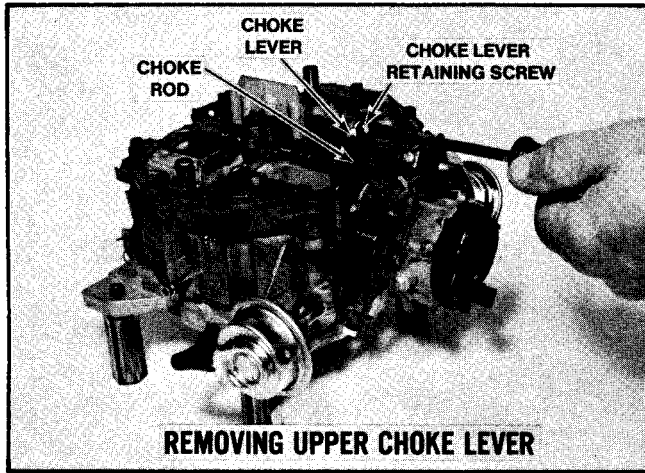

Figure 43 Removing Upper Choke Lever

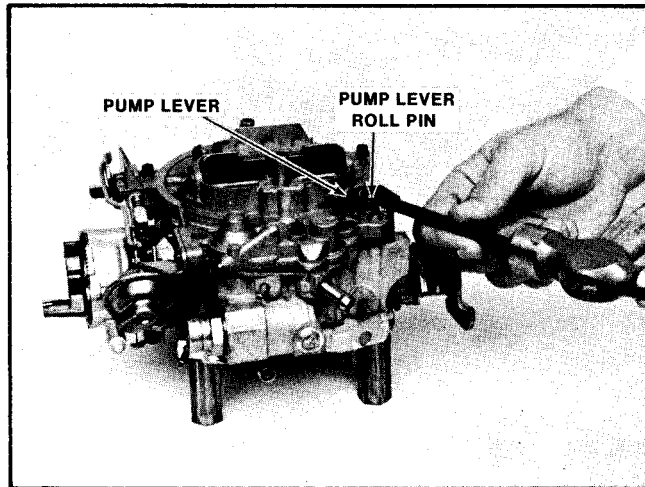

Figure 44 Pump Lever Removal

3. Remove upper choke lever from the end of choke shaft by removing retaining screw (Figure 43). Then, rotate lever to remove choke rod from slot in lever.

**NOTICE:** On models using a clip at the upper end of the choke rod, remove clip from rod and disconnect upper end of choke rod from choke shaft lever.

4. Remove choke rod from lower lever inside the float bowl casting.

**NOTICE:** Remove rod by holding lower lever outward with small screwdriver and twisting rod counterclockwise.

5. With tool BT 7523 or equivalent, drive small roll pin (pump lever pivot pin) inward just enough until pump lever can be removed from air horn (Figure 44). Then remove pump lever from pump rod. Note location of rod (if in inner or outer hole) for later reassembly.

**NOTICE:** Do not remove roll pin completely during removal or disassembly of air horn. Use care in driving small roll pin to pre-

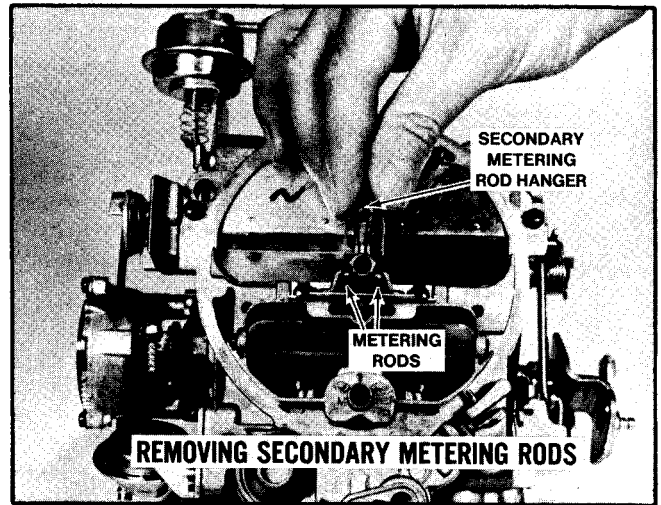

Figure 45 Secondary Metering Rod Removal

vent damage to pump lever casting bosses in air horn.

On those models that use a retaining clip in the upper end of the pump rod, remove clip from upper end of the pump rod; then disconnect pump rod from pump lever. Wire vent valve lever can be removed from pump lever if replacement is necessary.

Do not bend the pump rod to remove from pump lever; follow the above procedures.

6. Remove secondary metering rods from secondary orifice plates by removing small screw in the secondary metering rod hanger (Figure 45). Lift holder and rods as an assembly straight up from the carburetor. Metering rods may be disassembled from the hanger by rotating ends out of the holes in the end of the hanger.

7. For early models with air valve dashpot, remove end of dashpot plunger rod from air valve lever. Some slide out of lever and others are held by a retaining clip. The dashpot piston has a synthetic seal inside the piston on the plunger shaft.

**NOTICE:** The seal should not be immersed in carburetor cleaner as the seal will be destroyed.

8. Remove air horn to bowl attaching screws (Figure 46); early models have 9 screws, later models have 13 screws for better control of evaporative emissions. If used, remove bowl vent valve cover, spring and gasket from beneath front air horn screw.

9. If used, remove idle vent valve attaching screw; then remove idle vent valve assembly. If thermostatic vent valve is used, remove dust cover, then remove valve. Care should be used not to bend or distort the bi-metal strip.

On those 4MV models using the vacuum operated vent switch valve, remove small screw from top of vent valve plunger stem.

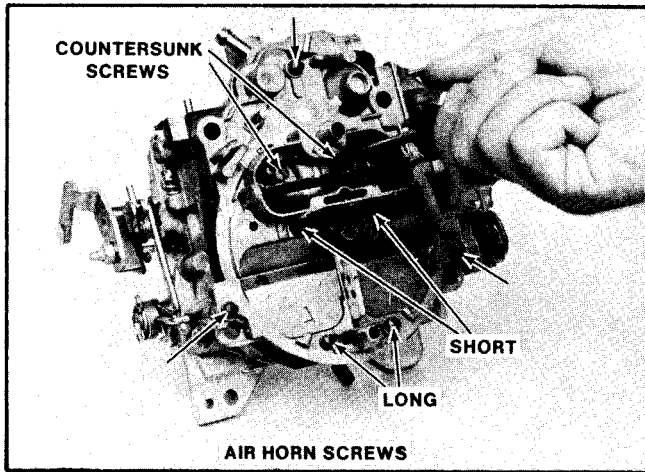

Figure 46 Air Horn Screw Removal

**NOTICE:** Some models have a secondary baffle plate mounted under the (2) center air horn attaching screws next to the secondary bores (Nos. 3 and 4). The baffle can be removed also at this time. Other models have a secondary air valve lockout shield located over the lockout lever. This is held in place by the air horn screw next to the lockout lever and a small attaching screw. (Check the "C" parts bulletin in the Delco Carburetor Parts and Service Manual 9X for correct usage of these parts).

10. Remove air horn from float bowl by lifting straight up (Figure 47). On 4MV-4MC models, rotate air horn to remove vacuum break rod from dashpot lever on end of the air valve shaft. Air horn gasket should remain on bowl for removal later.

**NOTICE:** Place air horn inverted on clean bench. When removing air horn from float bowl, use care to prevent bending the small tubes protruding from the air horn. These tubes are permanently pressed into the air horn casting. **DO NOT REMOVE.**

11. If not removed previously, remove front vacuum break hose. Then remove vacuum break control and bracket assembly. The diaphragm assembly may now be removed from the air valve dashpot rod and the dashpot rod from the air valve lever.

12. For later models that use a pump plunger stem seal (Figure 48), remove seal by inverting air horn and use Tool BT-7954 or equivalent to remove seal retainer ring. Discard retainer and seal.

**NOTICE:** Use care in removing the pump plunger stem seal retainer to prevent damage to air horn casting. A new seal and retainer are required for reassembly.

Further disassembly of the air horn is not required for cleaning purposes.

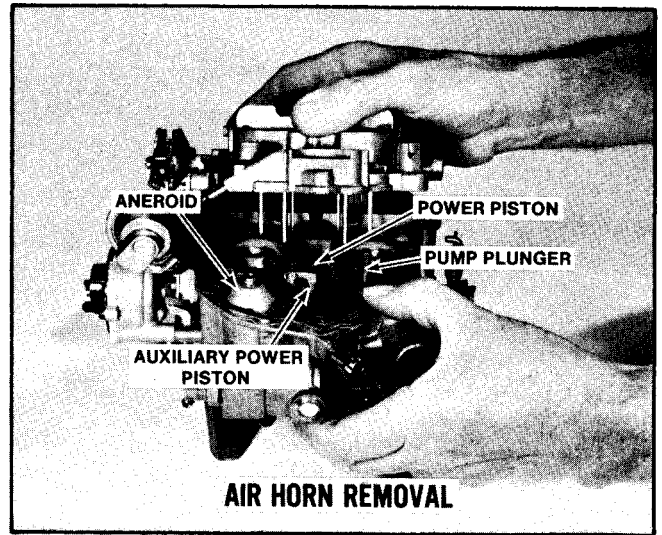

Figure 47 Air Horn Removal

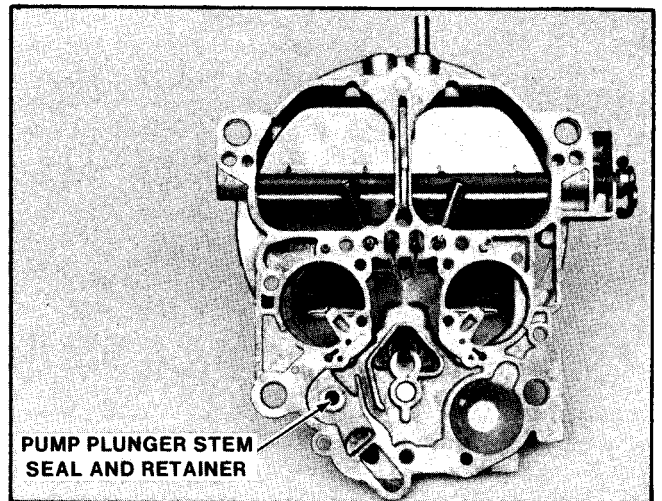

Figure 48 Pump Plunger Stem Seal

## AIR HORN DISASSEMBLY

If part replacement is required, proceed as follows:

**NOTICE:** On "modified" models using the bowl vent valve, the bowl vent valve and actuating arm are permanently retained in the air horn. **DO NOT REMOVE.**

1. Remove staking on (2) choke valve attaching screws; then remove choke valve screws, valve, and shaft from air horn.

2. If the air horn is equipped with an air valve lockout lever and it needs replacement, remove the lockout lever by driving out roll pin with small drift punch.

**NOTICE:** Air valves and air valve shaft should not be removed. However, if it is necessary to replace the air valve closing spring or center plastic eccentric cam, a repair kit is available. Refer to the "C" Parts

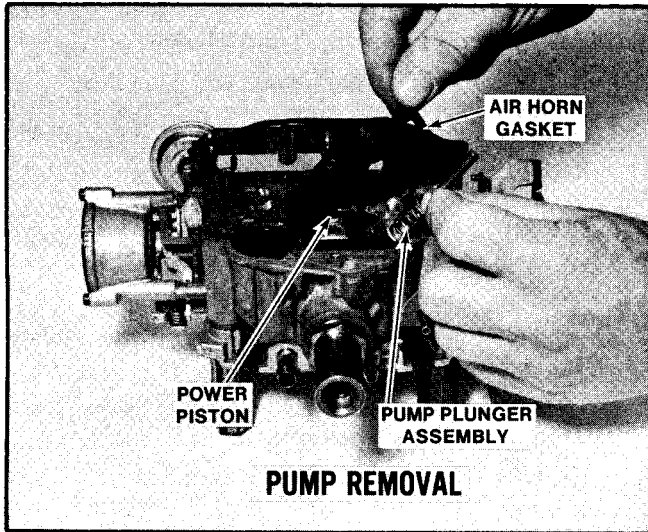

Figure 49 Pump Removal

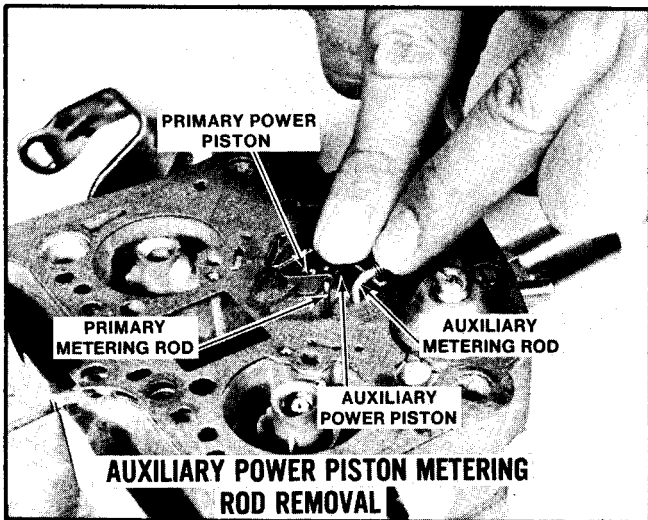

Figure 50 Auxiliary Power Piston Metering Rod Removal

Bulletin in the Delco Carburetor Parts and Service Manual (9X) for part number application.

Instructions for assembly are included in the repair kit.

## FLOAT BOWL DISASSEMBLY

1. Carefully lift corner of air horn gasket and remove pump plunger from pump well (Figure 49).

**NOTICE:** On "modified" models, carefully loosen air horn gasket and lift one corner to remove pump plunger from pump well.

2. If used, remove bowl vent valve spacer from pump plunger stem.

3. Remove air horn gasket from dowels on secondary

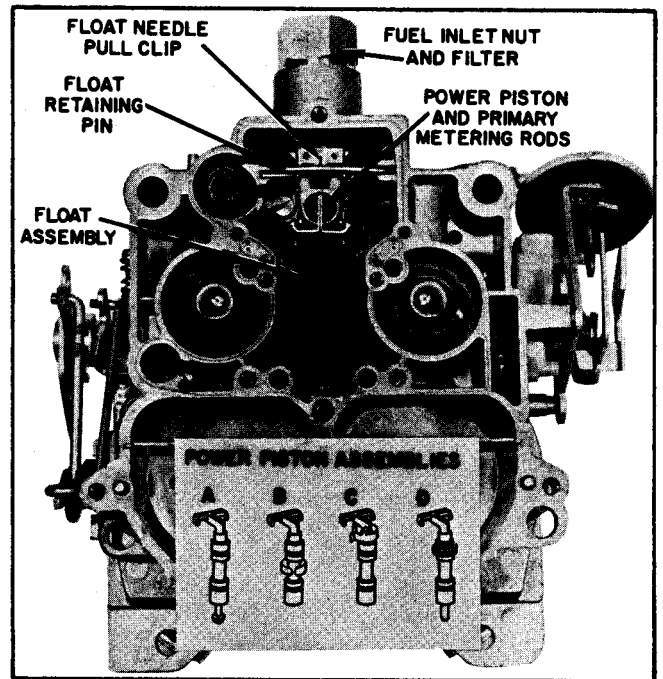

Figure 51 Power Piston Assemblies

side of bowl; then remove gasket from around the main power piston and attached primary metering rods by lifting tab of gasket from beneath the hanger (being careful not to distort the small springs that hold the metering rods in place) and lift gasket from the bowl.

4. For models that have an auxiliary (front) power piston (as shown in Figure 50), hold auxiliary power piston and swing hanger toward front of carburetor while at the same time pushing rearward on metering rod and compressing rod spring retainer until groove in rod aligns with slot in hanger. Then remove rod by lifting it up and out of the fixed metering jet. Hold main (rear) primary power piston down and swing auxiliary (front) power piston hanger rearward until it touches the primary power piston — then release the primary piston and remove air horn gasket per step 3 above.

5. Remove pump return spring from pump well.

6. Remove main power piston and metering rods as an assembly. There are four different types of power piston retainers used (Figure 51).

a. The first design has a "button head" pin extension pressed into the base of the power piston. This type power piston is held in place by the "button head" which protrudes through a hole in the throttle body gasket. The power piston can be removed by using needle-nosed pliers to pull straight up on metering rod hanger directly over power piston.

b. The second type power piston retainer is a flat brass spring clip which fits around the power piston, at the center. This type power piston assembly is removed in the same manner as above.

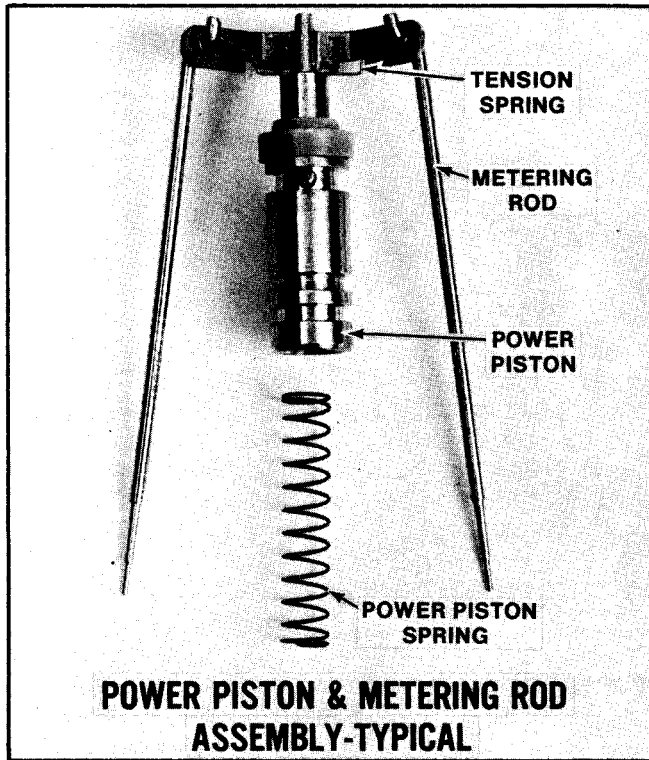

Figure 52 Power Piston-Metering Rod Assembly

c. The third type power piston retainer is a spring clip which fits over and around the top of the power piston cavity. Two fingers at the top of the clip hold the piston down in the cavity. This type power piston can be removed by pushing upward on the clip retainer to disengage it from the casting.

d. The fourth power piston retainer is a plastic retainer which is part of the power piston assembly. The plastic retainer fits in a recess at the top of the power piston cavity. The power piston with the plastic retainer can be removed by pushing the piston downward against spring tension and allowing it to snap back against the retainer. Repeat this snap back action until it "pops" out of casting. This procedure may have to be repeated several times to free the power piston retainer. Do not attempt to remove this type power piston by using pliers on metering rod hanger, as irreparable damage to the piston assembly may be caused.

7. Remove metering rods from main power piston hanger by disconnecting tension spring loop from top of each rod (Figure 52); then, rotate rod to remove from hanger.

**NOTICE:** Use care when disassembling rods to prevent distortion of tension spring and/or metering rods. Note carefully position of tension spring for later reassembly.

8. Remove the power piston spring(s) from the well.

9. If used, remove auxiliary (front) power piston by depressing piston stem and allowing it to snap free

(following procedure noted in Step 6d, above). Remove auxiliary power piston spring from the well.

**NOTICE:** The main (rear) and auxiliary (front) power piston springs must NOT be interchanged. To prevent mixing of springs, lightly wrap a piece of masking tape around the auxiliary power piston spring for identification. The auxiliary (front) power piston spring is the longer of the two springs.

10. Remove plastic filler block over float valve.

11. Remove float assembly and float needle by pulling up on hinge pin.

12. Remove inlet needle seat and gasket using Tool BT-3006M or wide blade screwdriver.

**NOTICE:** Float needle and seat are factory matched and tested and should be replaced only as a set.

For diaphragm type float assemblies (early models):

a. Remove float assembly by pulling upward on hinge pin until pin can be removed from float hanger by sliding toward pump well. After pin is removed, slide float assembly toward front of bowl to disengage needle pull clip from float arm. Do not distort float needle pull clip.

b. Using needle-nosed pliers, remove pull clip from float needle.

c. Remove two screws from float needle diaphragm retainer; then remove retainer and float valve assembly from bowl.

**NOTICE:** Valve seat is factory staked and tested. Do not attempt to remove or restake. If damaged, replace float bowl assembly.

## APT METERING ROD - WITH ANEROID OR FILLER SPOOL

13. On later "modified" models that use the APT (adjustable part throttle) metering rod assembly with aneroid or filler spool, remove two cover screws and carefully lift the metering rod assembly from the float bowl cavity (Figure 53).

**NOTICE:** The APT metering rod assembly, with aneroid or filler spool, is extremely fragile. Use care in handling these critical parts. Do not immerse aneroid or filler spool in carburetor cleaner. The APT metering rod assembly is pre-set at the factory and NO attempt should be made to readjust in the field. If replacement is necessary, see APT Metering Rod Replacement (Step 7a, page 38).

14. Many models have a simple blank insert installed in the aneroid bowl cavity (Figure 53). Remove insert.

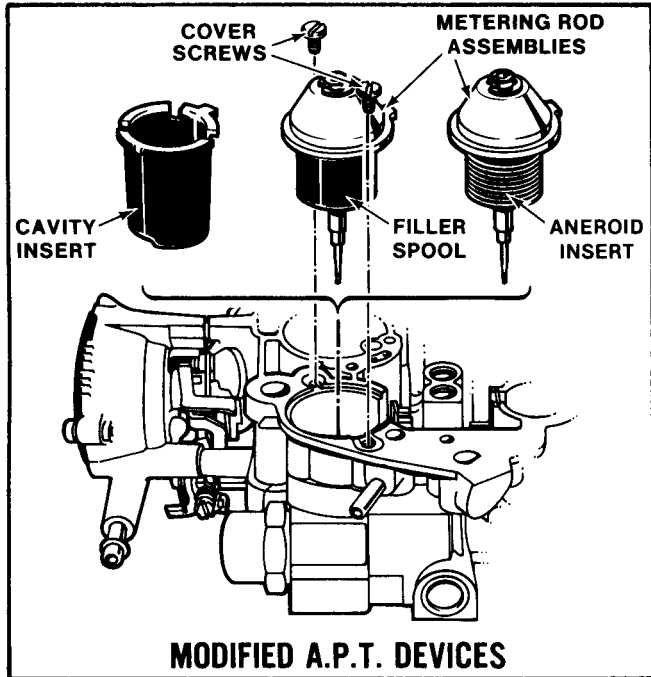

Figure 53 Modified APT Devices

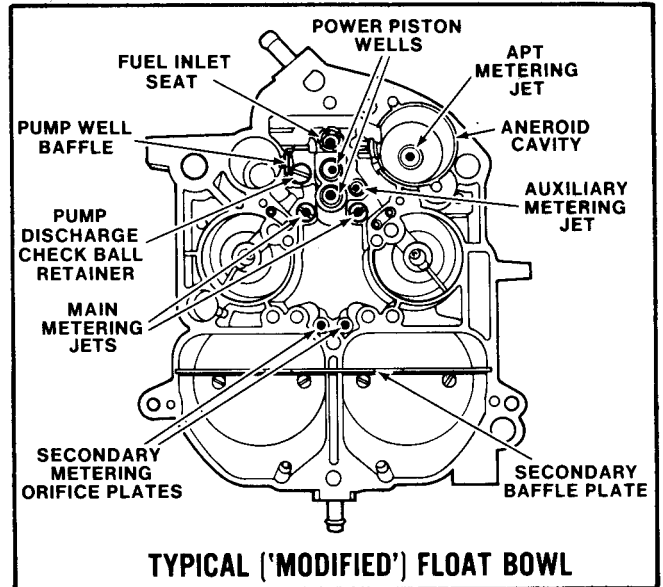

Figure 54 M4MC-M4ME "Modified" Float Bowl - Typical

**NOTICE:** On M4MC-M4ME models that have an APT Metering Rod Adjustment screw in the float bowl (located in a well next to the main power piston), the screw is pre-set at the factory and no attempt should be made to change this adjustment in Service. If float bowl replacement is required for service, the new bowl assembly will be supplied with the APT metering screw pre-set as required.

15. Remove main metering jets only if necessary (Figure 54).

**NOTICE:** No attempt should be made to remove the auxiliary (front) power piston metering jet, APT metering jet, or secondary metering orifice plates. Normal cleaning is all that is necessary. These jets are fixed and, if damaged, float bowl replacement is required.

16. Using a screwdriver, remove pump discharge check ball retainer, then steel check ball (Figure 54).

17. If used, remove baffle from side of pump well fill slot.

18. The baffle plate in the secondary bores need not be removed for cleaning purposes. If replacement is necessary, remove plate by lifting upward out of slots in side of bores.

### 19. CHOKE MECHANISM DISASSEMBLY

#### A. Vacuum Break Removal

1. Remove vacuum break hose from main vacuum break assembly and, if used, from rear (or auxiliary)

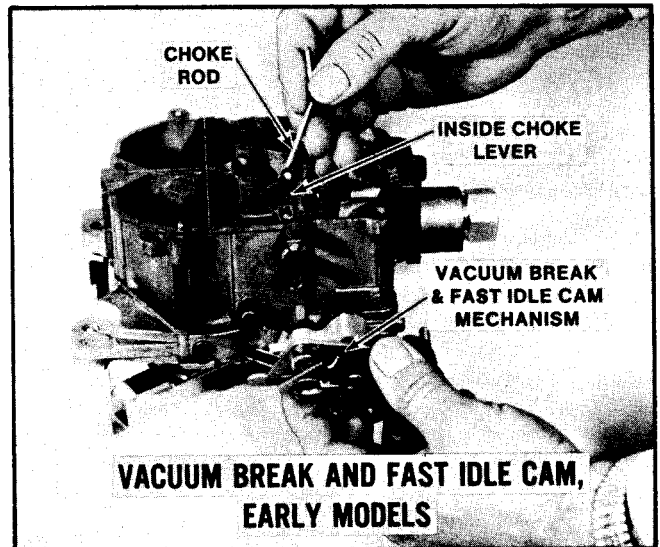

Figure 55 Vacuum Break and Fast Idle Cam - Early Models

vacuum break assembly, and remove hose(s) from connection on float bowl.

2. Remove retaining screw from choke vacuum break bracket assembly and remove assembly from float bowl. If not removed previously, vacuum break rod can now be removed from the main vacuum break plunger by rotating rod out of plunger stem (Figure 55).

3. Remove secondary lockout lever, or idle speed-up lever (where used), from projection on bowl casting.

4. Remove the fast idle cam from bushing on choke vacuum break bracket assembly.

**NOTICE:** If further disassembly of the choke

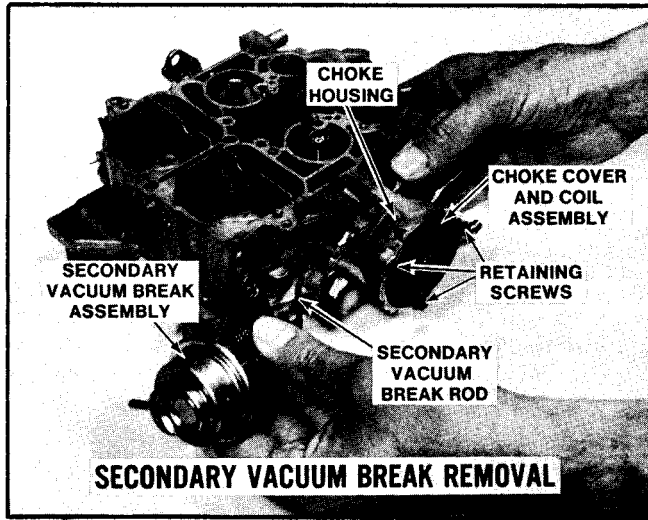

Figure 56 Secondary Vacuum Break Removal

mechanism is necessary, the vacuum break assemblies can be removed as follows:

a) (Early Models) Remove clip on connecting link at vacuum break lever. Then, remove link from lever and vacuum break diaphragm plunger.

b) Some models have vacuum break units attached to the brackets by retaining ears which are bent together to hold the diaphragm assembly. Where found, the retaining ears must be spread to unclamp either the primary (front) or secondary (rear) vacuum break assembly.

c) Late models have integral vacuum break diaphragm-bracket assemblies. Remove attaching screws holding units to float bowl. The secondary vacuum break assembly has a rod connecting the plunger to the intermediate choke shaft lever. This can also be removed by rotating the vacuum break diaphragm assembly by sliding the rod out of the plunger stem and the other end out of the vacuum break lever (See Figure 56).

**NOTICE:** Do not place vacuum break units in carburetor cleaner.

#### B. Choke Disassembly (Early Models)

1. Remove three attaching screws and retainers from choke cover and coil assembly. Then pull straight outward to remove cover and coil assembly from choke housing. Remove choke cover gasket if used.

**NOTICE:** A cover scribe mark is located relative to the index marks cast into the choke housing. The cover position should be noted at time of disassembly so that cover indexing can be restored upon reassembly.

**NOTICE:** It is not necessary to remove baffle plate from beneath the thermostatic coil on hot air choke models. Distortion of the thermostatic coil may result if forced off the center retaining post on the choke cover.

2. Remove choke housing assembly from float bowl

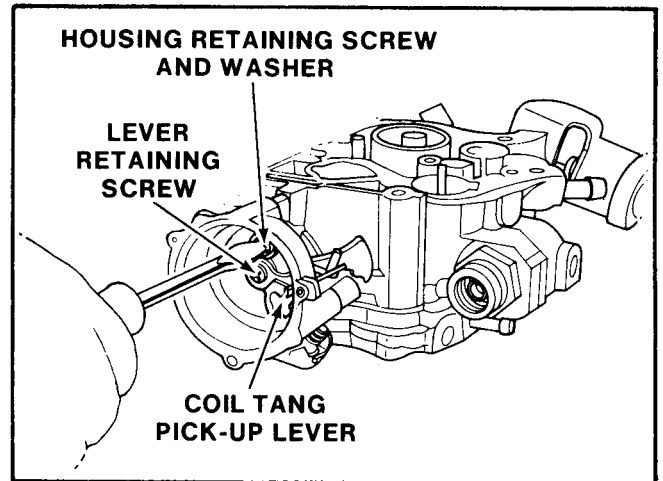

Figure 57 Choke Housing Removal

by removing retaining screw and washer inside the choke housing (Figure 57). The complete choke assembly can be removed from the float bowl by sliding outward.

3. Remove lower choke lever from inside float bowl cavity by inverting bowl.

4. Remove plastic tube seal from choke housing if used.

**NOTICE:** Plastic tube seal should not be immersed in carburetor cleaner.

5. To disassemble intermediate choke shaft from choke housing, remove coil lever retainer screw. Then remove lever from flats on intermediate choke shaft. Remove intermediate shaft from the choke housing by sliding outward. The fast idle cam can now be removed from the intermediate choke shaft.

6. Remove the cup seal from inside choke housing shaft hole if the housing is to be immersed in carburetor cleaner. Also, remove cup seal from the float bowl insert for bowl cleaning purposes (Figure 58).

**NOTICE:** Do not attempt to remove bowl insert.

#### C. Choke Disassembly (Late Models)

Late model carburetors have a tamper resistant choke cover locating and retention method. Cover and coil assembly retainer screws (early models) have been replaced by rivets to discourage choke readjustment in the field. Should it be necessary to remove the cover and coil assembly or choke housing for cleaning, overhaul or replacement, proceed as follows:

### CHOKE COVER REMOVAL

1. Support float bowl and throttle body as an assembly on a suitable holding fixture such as tool BT-30-15.

2. Carefully align a #21 drill (.159") on rivet head and drill enough to remove the three rivet heads (Figure 59) and then, using a drift and small hammer, drive the remainder of the rivets out of the choke housing.



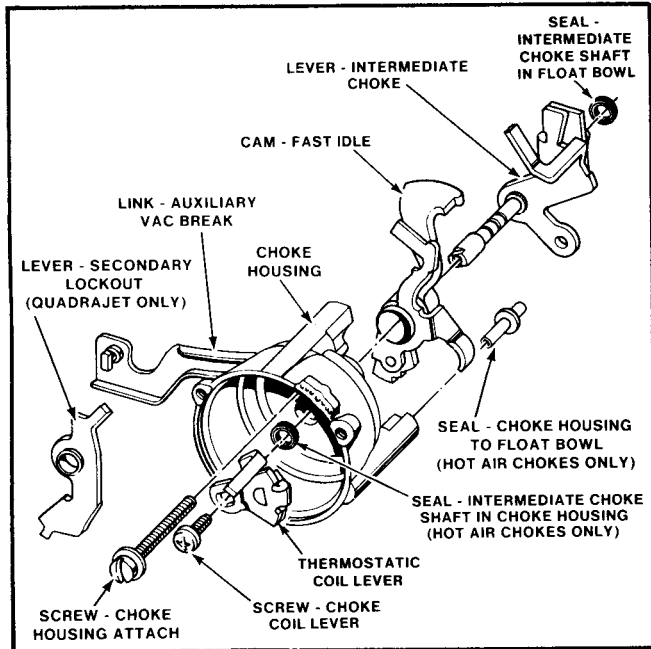

Figure 58 Choke Assembly - Typical

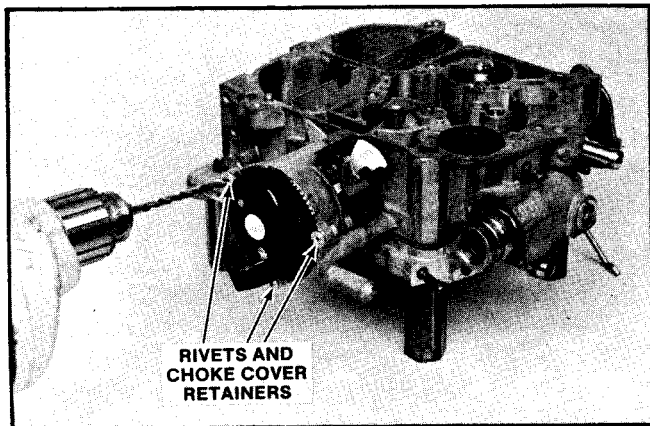

Figure 59 Choke Cover Removal - Late Models

**NOTICE:** On tamper resistant models a special cut-out is notched in the choke cover which is aligned with an extended tab on one cover retainer which is located at the 2 o'clock position. This is a locating method that properly indexes the cover and coil assembly within the choke housing.

3. Remove choke cover and coil assembly from choke housing. Remove choke cover gasket, if used; also remove inside baffle plate, if used.

4. Remove choke housing assembly from float bowl using procedures described previously for early models.

## DISASSEMBLY OF REMAINING FLOAT BOWL PARTS

1. If used, remove hot idle compensator by removing

(2) screws in compensator cover at rear of float bowl. Remove cover, hot idle compensator, and "O" ring seal in bowl cavity recess beneath compensator.

Some models have the hot idle compensator located adjacent to the pump well area. Remove hot idle compensator assembly and cork "O" ring.

**NOTICE:** Hot idle compensator "O" ring seal is to be replaced with a new seal at time of reassembly.

2. Remove fuel inlet nut, gasket, filter assembly and spring (Figure 60). Some models use a fuel strainer in place of a filter and spring. Consult the parts list for each model for proper parts application.

3. Invert float bowl - throttle body assembly and place on a clean flat surface. Remove throttle body by removing throttle body to bowl attaching screws (Figure 61). Lift throttle body from bowl.

4. Remove throttle body to bowl insulator gasket.

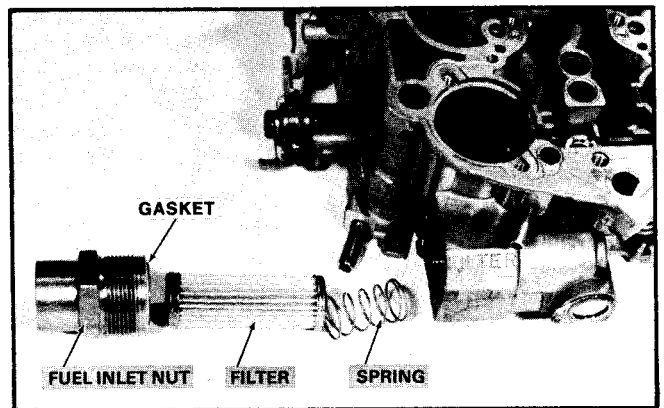

Figure 60 Fuel Filter Assembly - Typical

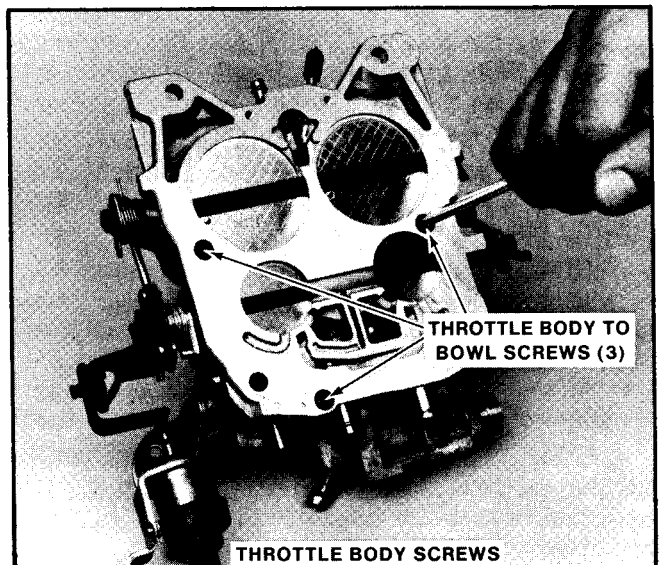

Figure 61 Throttle Body Removal





## THROTTLE BODY DISASSEMBLY

**NOTICE:** Place throttle body assembly on carburetor holding fixture to protect throttle valves. Extreme care must be taken to avoid damaging throttle valves.

1. Remove pump rod from throttle lever by rotating rod out of primary throttle lever.
2. Further disassembly of the throttle body is not required for cleaning purposes. The throttle valve screws are permanently staked in place and should not be removed. The throttle body is serviced as a complete assembly.

**NOTICE:** Do not remove the steel plugs that cover the idle mixture needles (late models) or the plastic limiter caps that are found on some models. These devices are installed to protect critical factory settings and to meet emissions control regulations. If problem diagnosis indicates that the carburetor is at fault relative to a driver complaint, an emissions failure, or if normal soaking and air pressure fails to clean the idle passages, or if idle needle or throttle body replacement is required, only then may the plugs or limiter caps be removed in order to perform necessary service.

If plug removal is required to replace idle needles or to perform necessary adjustments, proceed as follows (Figure 62):

- a. Make two parallel cuts in the throttle body between the locator points beneath the idle mixture needle plugs with a hack saw (Step 1). The cuts should reach down to the steel plug but should not extend more than 1/8" beyond the locator points. The distance between the saw marks depends on the size of the punch to be used.
- b. Place a flat punch at a point near the ends of the saw marks in the throttle body. Holding the punch at a 45° angle, drive it into the throttle body until the casting breaks away, exposing the steel plug (Step 2).
- c. Holding a center punch vertical, drive it into the steel plug. Then, holding the punch at a 45° angle, drive the plug out of the casting.

**NOTICE:** Hardened plug will break rather than remaining intact. It is not necessary to remove the plug completely; instead, remove loose pieces to allow use of idle mixture adjusting tool J-29030 or BT-7610B (or equivalent).

- d. Using Tool J-29030, or BT-7610B, adjust idle mixture needle according to specifications. If the idle mixture needles are removed, readjust the idle mixture per recommended instructions furnished by the vehicle manufacturer or provided in AC-Delco Service Bulletins SD-100, SD100A or 9D-1978A.

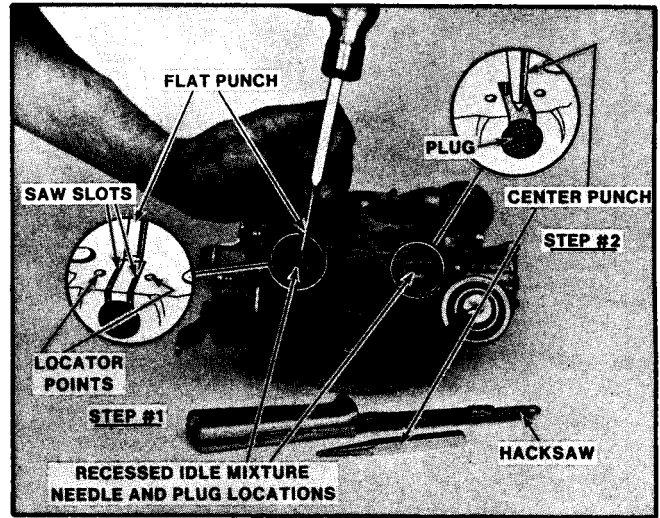

Figure 62 Idle Mixture Plug Removal

**NOTICE:** Before removing the idle mixture needle, it is suggested that the old needle be lightly bottomed and the number of turns to bottom be recorded. Then, when installing the new needle, lightly bottom, then back off the number of turns it took to bottom the old needle. Proceed to adjust needles to final idle mixture following procedures and specifications.

**NOTICE:** After idle mixture adjustment is complete on models where plugs were removed, it is advised that the needle settings be sealed with a silicone sealant RTV rubber or equivalent to prevent fuel vapor loss. If necessary to remove the idle mixture needles with idle limiter caps, destroy the limiter caps. Do not install a replacement cap as a bare mixture screw is sufficient evidence to indicate that the mixture has been readjusted.

## CLEANING AND INSPECTION

1. Thoroughly clean carburetor castings and metal parts in an approved carburetor cleaner, such as Carbon X (X-55) or its equivalent.

**NOTICE:** The following should NOT be immersed in carburetor cleaner as they will swell, harden, or distort:

- A. The electric choke, any rubber parts, electric solenoid, plastic parts, diaphragms, pump plunger, aneroid, filler spool, or aneroid cavity insert
- B. Vacuum Break Assemblies
- C. Choke housing plastic tube seal or gasket
- D. Choke coil and cover assembly
- E. Intermediate choke lever shaft cup seal recessed in float bowl insert



F. If choke housing is to be immersed in carburetor cleaner, remove the cup seal from inside the choke housing shaft hole

G. Fuel filter assembly, and check valve (if used)

H. Idle stop solenoid, A/C idle speed solenoid, throttle closing dashpot, throttle lever actuator, C.E.C. solenoid.

The plastic cam on the air valve shaft will withstand normal cleaning in carburetor cleaner (rinse thoroughly after cleaning).

Do not attempt to remove bowl insert. The bushing will withstand normal cleaning. (Rinse thoroughly after cleaning).

2. Thoroughly clean all metal parts and blow dry with shop air. Make sure all fuel passages and metering parts are free of burrs and dirt. Do not pass drills or wire through jets and passages.

3. Inspect upper and lower surface of carburetor castings for damage.

4. Inspect holes in levers for excessive wear or out of round conditions. If worn, levers should be replaced.

5. Check, repair, or replace parts if the following problems are encountered:

#### A. Flooding

1. Inspect float needle and seat for dirt, deep wear grooves, scores, and proper seating. (Needle and seat checking tool BT-6513 may be used to check the seal of the standard type needle in the seat).

**NOTICE:** When checking the rubber tipped needle, do not exceed 3" of vacuum for six seconds to prevent distortion of the rubber tip.

2. Inspect float needle pull clip for proper installation. Be careful not to bend needle pull clip.

3. Inspect float, float arms and hinge pin for distortion, binds, and burrs. Check density of material in the float; if heavier than normal, replace float.

4. Clean or replace fuel inlet strainer or filter.

#### B. Hesitation

1. Inspect pump plunger for cracks, scores, or excessive cup wear.

2. Inspect pump duration and return springs for being weak or distorted.

3. Check all pump passages and jets for dirt, improper seating inlet or discharge balls, scores in pump well.

4. Check pump linkage for excessive wear, repair or replace as necessary.

#### C. Hard Starting-Poor Cold Operation

1. Inspect inlet needle for sticking, dirt, etc.

2. Examine fast idle cam for wear or damage.

3. Also check items under "Flooding".

#### D. Poor Performance - Poor Gas Mileage

1. Clean all fuel and vacuum passages in castings.

2. Check choke valve for freedom of movement.

3. Inspect power piston(s), metering rods and jets for dirt, sticking, binding, damaged parts or excessive wear.

4. Check air valve for binding condition. If air valve is damaged, the air horn assembly must be replaced. A torsion spring kit is available for repairs to the air valve closing spring. A new plastic eccentric cam is included in the kit.

#### E. Rough Idle

1. Inspect gasket mating surfaces on castings for damage to sealing beads, nicks or burrs.

2. Clean all idle fuel passages.

3. Check throttle lever and valves for binds, nicks and other damage.

4. If removed, inspect mixture needles for ridges, burrs, or being bent. Install idle mixture needles and springs until needles are lightly seated. Back out mixture needles specified number of turns as an initial adjustment.

**NOTICE:** Final idle mixture and idle speed settings should be made on the car following the vehicle manufacturer's procedures and specifications noted in the service manual or AC-Delco Service Bulletins SD-100, SD-100A, or 9D-1978A.

5. Check all diaphragms for possible ruptures or leaks.

6. Clean plastic parts only in cleaning solvent - never in gasoline.

## CARBURETOR ASSEMBLY

### Throttle Body Reassembly

1. If removed, install fast idle cam follower, fast idle lever on end of primary throttle shaft. Install torsion spring (where used) and retaining screw in end of shaft. Tighten securely.

2. If removed, install idle mixture needles and springs until lightly seated. Then, as a preliminary idle mixture adjustment, back out the mixture needles number of turns counted at time of disassembly (see step 2, Page 34), or back out mixture needles number of turns specified by the vehicle manufacturer. Final adjustment must be made on the engine using the procedures and specifications of the vehicle manufacturer.

**NOTICE:** Do not force the idle mixture needle against the seat or damage will result.

3. Install lower end of pump rod in throttle lever by aligning tang on rod with slot in lever. End of rod should point outward toward throttle lever.



### Float Bowl Reassembly (Refer to Figures 49 through 60)

1. Install new throttle body to bowl insulator gasket making sure the gasket is properly positioned on two locating dowels on bottom of float bowl.

2. Install throttle body on bowl making certain throttle body is properly located over dowels on float bowl; then install throttle body to bowl screws (and lockwashers, if used) and tighten evenly and securely.

**NOTICE:** If a new (service) throttle body is used on 4MV-4MC models, be sure to perform APT setting procedures as described on page 42. Place carburetor on proper holding fixture (such as BT-30-15).

3. Install fuel inlet strainer, or filter (and check valve, if used), spring, new gasket and inlet nut. Tighten nut securely (18 ft. lbs.). The filter spring is not used on models that have a fuel strainer.

**NOTICE:** When installing a service replacement filter, make sure the filter is the type that includes the check valve, if required, to meet government safety standards. New service replacement filters with check valve meet this requirement. When properly installed, hole in filter faces toward inlet nut. Ribs on closed end of filter element prevent filter from being installed incorrectly unless forced. Tightening beyond specified torque can damage nylon gasket.

4. If used, install hot idle compensator "O" ring seal in recess in bowl, then install hot idle compensator. Install compensator cover and (2) retaining screws. Tighten screws securely.

**NOTICE:** On those models having the compensator located in the float bowl adjacent to the pump well area, install "O" ring cork seal and hot idle compensator in cavity in float bowl.

### 4MV Choke Assembly

5. If the vacuum break diaphragm (s) was removed from the bracket, slide vacuum break diaphragm between retaining ears and bend ears down slightly to hold securely.

**NOTICE:** If a second (auxiliary) vacuum break diaphragm is used, the vacuum diaphragm rod must be installed in the vacuum break lever and plunger stem prior to installing the unit on the choke bracket.

### Early Models

Install vacuum break link (U-bend end) in slot in diaphragm plunger. End of link should be on inside of slot toward choke bracket. Install other end of vacuum break link in hole on vacuum break lever and retain with clip.

6. Install the secondary lockout lever (or idle speed-up lever, if used,) on the bearing pin on the float bowl.

7. Install fast idle cam on the choke shaft making sure the cam actuating tang on the intermediate choke shaft lever is located on the underside of the tail of the fast idle cam, or in slot of fast idle cam.

### Assembly of Choke Housing to Float Bowl

1. If used, install new cup seal into insert on side of float bowl for intermediate choke shaft. Lip on cup seal faces outward.

2. Install secondary throttle valve lockout lever (if used) on boss on float bowl with recess in hole in lever facing inward (Figure 63).

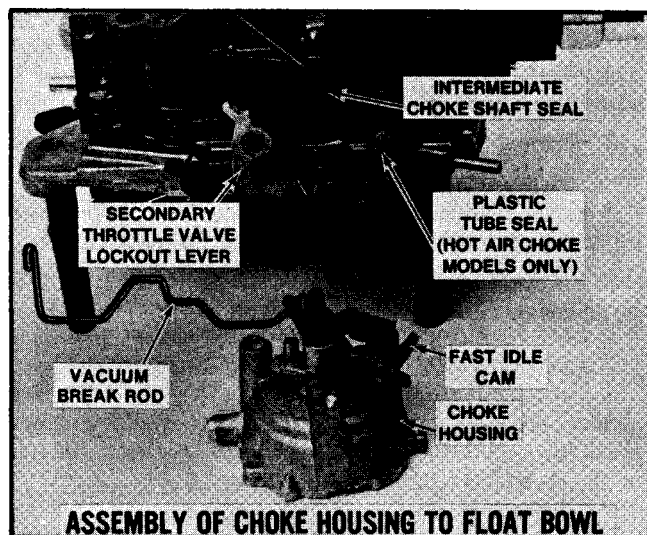

Figure 63 Assembly of Choke Housing to Float Bowl

3. If used, install new cup seal into inside choke housing shaft hole. Lip on seal faces inward, toward float bowl.

4. Install fast idle cam onto the intermediate choke shaft (steps on fast idle cam face downward).

5. Except on early 4MC models, carefully install fast idle cam and intermediate choke shaft assembly through seal in choke housing; then install thermostatic coil lever onto flats on intermediate choke shaft. The thermostatic choke coil lever is properly aligned when both inside and outside levers face toward fuel inlet. Install inside lever retaining screw into end of intermediate choke shaft. Tighten screw securely.

6. Install choke rod (plain end) into hole in lower choke rod inner lever; then holding choke rod with lower end pointing outward, lower choke rod inner lever into cavity in float bowl. Install plastic tube seal (if used) into cavity on choke housing before assembling choke housing to bowl. On early 4MC models with vacuum diaphragm unit integral with choke housing, install small gasket on vacuum passage between choke



housing and float bowl. Install choke housing to bowl sliding intermediate choke shaft into lower choke inner lever.

**NOTICE:** Tool BT-6911 can be used to hold the lower choke rod inner lever in correct position while installing the choke housing as shown in Figure 64.

7. Install choke housing retaining screw and washer and tighten securely.

**NOTICE:** The intermediate choke shaft lever and fast idle cam are in correct relation when the tang on lever is beneath the fast idle cam. Do not install choke cover and coil assembly until inside coil lever is adjusted (see Adjustment Procedures Bulletin 9D-5A of the Delco Parts and Service Manual 9X).

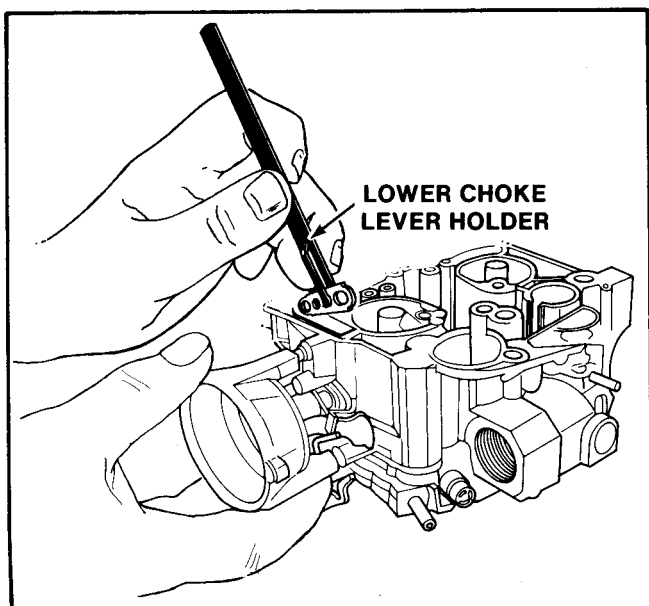

Figure 64 Installing Lower Choke Rod Lever

## COMPLETION OF FLOAT BOWL ASSEMBLY — ALL MODELS

**NOTICE:** Steps 1 and 2 pertain only to M4MC-M4ME units that use a rear vacuum break assembly.

1. Holding down on fast idle cam (hot idle position), install end of rear vacuum break rod in hole in intermediate choke lever.

2. Install end of vacuum break rod in slot in rear vacuum break plunger. Then install rear vacuum break and bracket assembly to float bowl using two attaching screws. Tighten securely.

**NOTICE:** Do not attach vacuum break hose until after the rear vacuum break adjustment is completed.

3. If removed, install baffle in secondary side of float bowl with notches toward top of bowl. Make sure baffle is seated and top is flush with casting surface.

4. On M4MC-M4ME models, install baffle inside pump well with slot toward bottom.

5. Install pump discharge ball and retainer in passage next to pump well. Tighten retainer securely.

6. Install primary main metering jets, if removed. **TIGHTEN SECURELY.**

7. On "modified" models that use an APT metering rod assembly with aneroid or filler spool, install metering rod assembly into float bowl, carefully aligning metering rod tip with hole in fixed jet. Tab on cover goes in slot in float bowl closest to the fuel inlet nut (Figure 66).

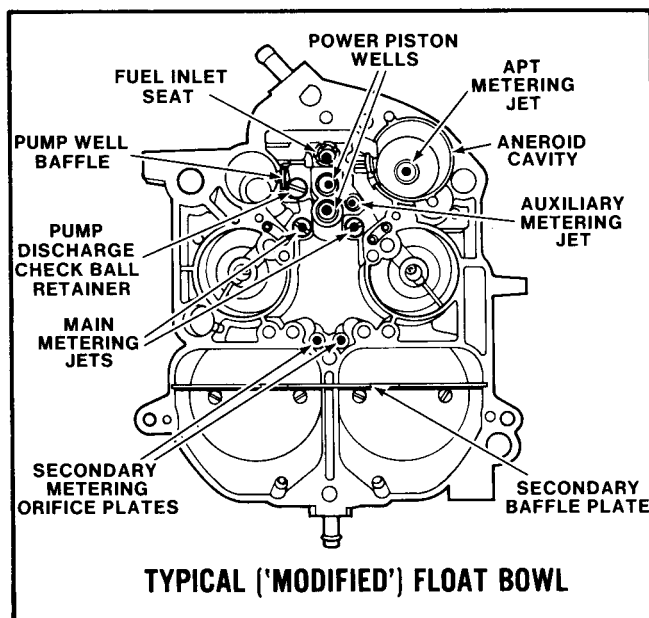

Figure 65 Float Bowl - Typical

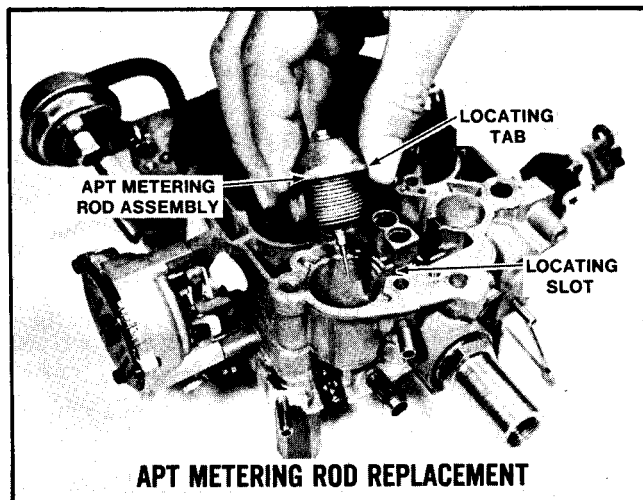

Figure 66 APT Metering Rod Replacement



**NOTICE:** The position of the APT metering rod, with aneroid or filler spool, in the fixed jet is extremely critical. Adjustment should NEVER be attempted unless replacement of the APT metering rod assembly is required due to damage to the rod, or failure of the original aneroid.

If required, the threaded metering rod assembly may be replaced as follows:

a. Note position of slot in adjusting screw of metering rod assembly and lightly scribe mark on cover.

b. With cover screws removed, carefully lift the metering rod and cover assembly from the float bowl.

**NOTICE: DO NOT** immerse the aneroid or filler spool in carburetor cleaner. The metering rod assembly, with aneroid or filler spool, is extremely fragile. Use care in handling these critical parts.

c. With metering rod and cover assembly held upright, using a small screwdriver, turn the adjusting screw counterclockwise, **carefully counting the number of turns until the threaded metering rod assembly bottoms in the cover.** Record number of turns counted for later reference (see Step f).

d. Remove "E" clip retainer from threaded end of rod. Then using small screwdriver, turn slotted rod clockwise until rod assembly disengages from cover.

**NOTICE:** Rod assembly is spring-loaded. Use care in removing rod assembly from cover.

e. Install tension spring on replacement metering rod assembly and thread rod and spring assembly into cover until the rod assembly bottoms in cover.

f. Using a small screwdriver, turn the adjusting screw clockwise until the rod is backed out of the cover **exactly the same number of turns from scribe line as recorded during disassembly** (see Step c).

**NOTICE:** When properly adjusted as above, slot in replacement APT metering rod assembly may not line up with scribe mark on cover.

g. Install "E" clip in groove in rod assembly, making sure clip is locked securely in place.

h. Carefully install cover and metering rod assembly onto float bowl aligning tab on cover assembly with slot in float bowl closest to the fuel inlet nut, (Figure 66).

**NOTICE:** Use care installing the metering rod and cover assembly into float bowl to prevent damaging or bending the metering rod tip.

i. Install cover attaching screws and tighten securely.

8. On other "modified" models that do not use the APT metering rod assembly with aneroid or filler spool, install aneroid cavity insert into float bowl.

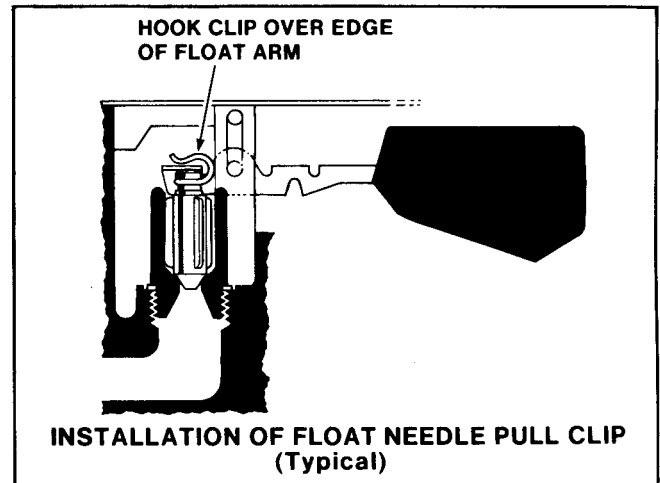

Figure 67 Float Needle Pull Clip Location

9. Install needle seat, with gasket, using tool BT-3006M.

10. To make float adjustment easier, carefully bend float arm upward at notch in arm before assembly.

11. Install needle by sliding float lever under pull clip from front to back. Correct installation of the needle pull clip is to hook the clip over edge of the float on the float arm facing the float pontoon (Figure 67). With float lever in pull clip, hold float assembly at toe and install hinge pin from pump well side (ends of hinge pin face the accelerating pump well).

**NOTICE:** Do not install float needle pull clip into holes in float arm. Severe flooding will result.

12. Install float needle and diaphragm assembly, making sure diaphragm is properly seated.

13. Install diaphragm retainer and two screws. Tighten securely.

14. Install float needle pull clip on float needle stem using needle nosed pliers. Pull clip is properly positioned with open end toward front of bowl.

15. Install float by sliding float lever into loop in pull clip. With lever in clip, hold float assembly at toe and install float hinge pin from pump well side. Be careful not to bend needle pull clip.

**NOTICE:** If desired, certain Quadrajets models may be converted from the diaphragm type needle and seat to the standard or conventional float needle and seat by installing a service modification kit. (Refer to 9C Parts Section of the Delco 9X Manual for specific applications and part number)

16. Carefully adjust float level following procedures and specifications listed in the vehicle manufacturer's service manual or in the "D" section of the Delco Carburetor Parts and Service Manual (9X).



17. On M4MC-M4ME models, install plastic filler block over float needle, pressing downward until properly seated.

18. Install power piston spring in power piston well.

**NOTICE:** If two power piston springs are used, the smaller spring seats in the center of the piston and bottoms on the float bowl casting. The larger diameter spring surrounds the small inner spring to exert additional pressure on the bottom of the power piston.

19. If primary metering rods were removed from hanger, reinstall making sure tension spring is connected to top of each rod (see Figures 52 or 68).

20. Install power piston assembly in well with metering rods carefully positioned in metering jets.

**NOTICE:**

a) On those models that have a "Button Head" pin extension pressed into the base of the power piston, press down firmly to insure engagement of retaining pin in throttle body gasket.

b) Some models use a spring clip over top of power piston well. On these, make sure clip is installed and seated.

c) On those which have a split ring retainer around the center of the power piston, carefully compress split ring and push piston down in well until it seats. This properly positions this type retainer.

On late models which use the plastic retainer on the top of the power piston (as shown Figure 68), install power piston in well and press down firmly on the plastic retainer forcing it into the recess in the bowl. Make sure it is properly seated. It may be necessary to tap the plastic retainer lightly in place with a hammer and drift. When installed correctly the plastic retainer is flush with the top of the float bowl casting.

21. On "modified" models with dual power pistons, remove masking tape, used for identification, and install auxiliary power piston spring in power piston well (front location — long spring).

Install auxiliary power piston assembly without metering rod in front well. Press down firmly on plastic power piston retainer to make sure the retainer is seated in recess in bowl and that the top is flush with the top of the float bowl casting. If necessary, using a drift punch and small hammer, tap retainer lightly in place.

22. On 4MV-4MC models, install plastic filler block over float needle, pressing downward until properly seated.

23. Install accelerator pump return spring in pump well.

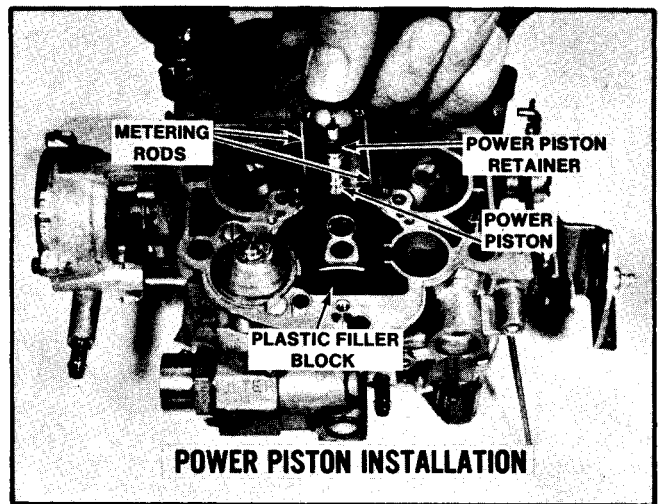

Figure 68 Power Piston Installation

24. On dual power piston models, hold main (rear) power piston down and swing auxiliary (front) power piston rearward until it touches the main power piston. Then release main power piston.

25. Install air horn gasket by carefully sliding tab of gasket around metering rods and beneath the power piston hanger. Position gasket over the two dowel pins on the float bowl.

**NOTICE:** Air horn gaskets for "modified" Quadrajets differ in that some have an extra hole forward of the main metering rod hanger, either for the auxiliary hanger (dual power piston models) or for the APT adjustment screw (Fig. 69). Be sure to use the correct gasket for the carburetor being worked on.

26. On dual power piston models, hold main (rear) power piston down and swing auxiliary power piston toward front of carburetor. Release main power piston.

Holding auxiliary power piston down with hanger toward front of carburetor, carefully insert the auxiliary metering rod in the fixed jet. Using finger to compress spring toward end of rod, slide rod onto small diameter groove in hanger and release spring. Correct spring location is on front side of hanger facing fuel inlet nut (Fig. 50). The hanger, when properly installed, will point toward rear of the metering rod cover (with aneroid or filler spool).

27. 4MV-4MC models — install accelerator pump plunger in pump well. M4MC-M4ME models — if used, install bowl vent valve spacer on accelerator pump plunger stem. Carefully lift corner of the air horn gasket and install accelerator pump plunger in the pump well by pushing the plunger to the bottom of the well against return spring force. While holding in this position, align pump plunger stem with hole in gasket and press gasket into place (Figure 69).

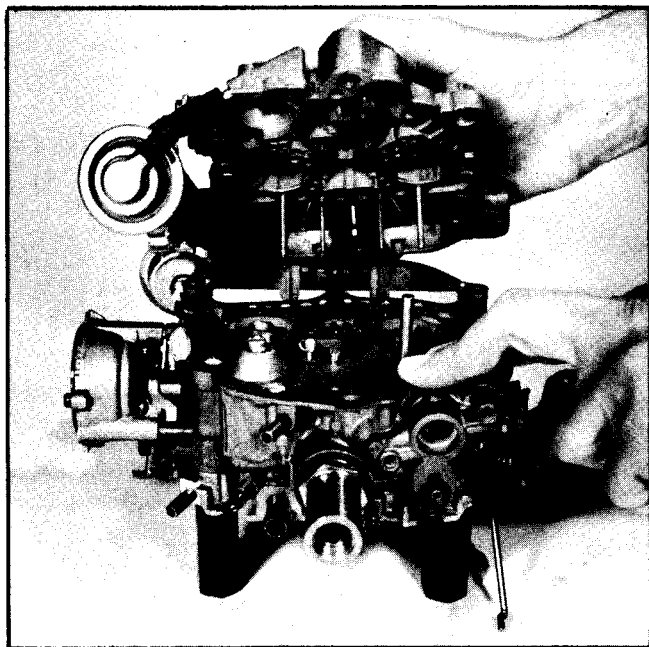

Figure 69 Installing Air Horn

## AIR HORN REASSEMBLY

1. Install the following, if removed:
  - a) Pump stem seal and retainer.
  - b) Choke shaft, choke valve and (2) attaching screws. Tighten screws securely in place.
  - c) Dashpot plunger rod through air horn and attached to air valve dashpot lever. Make sure clip retainer is installed (where used).
  - d) Air valve lockout lever (if used) - retain with roll pin. Make sure lever is free from binds.
  - e) Normally, the air valve and shaft do not have to be removed from the air horn for cleaning purposes. A repair kit is available which includes a new plastic cam, an air valve torsion spring, and retaining pin. Complete instructions for installation also are included in the kit. (Refer to the "C" Parts Bulletin in the Delco Carburetor Parts and Service Manual for part number application).

If it was necessary to replace the air valve closing spring and the air valve shaft was removed, install air valve shaft, plastic cam, air valves and four (4) attaching screws. Center air valves, tighten screws and stake in place. Make sure air valve operates freely with no binds. Then install air valve closing spring in air horn cavity. Insert spring pin, adjust pin, adjust air valve closing spring as outlined under adjustment procedures.

## AIR HORN TO BOWL INSTALLATION

1. 4MV-4MC models - Carefully lower air horn assembly onto float bowl, aligning bleed tubes, pull-over

enrichment tubes (if used), and accelerating well tubes with proper holes in gasket, and positioning pump plunger stem through hole in air horn.

On 4MV models using a "clipless" vacuum break rod, install vacuum break rod into main (front) vacuum break diaphragm plunger and into air valve lever on air horn before the air horn is lowered onto the float bowl.

Position pump plunger stem in air horn and dashpot (where used) in well in float bowl. Gently lower air horn assembly on gasket on float bowl, locating dowels through gasket until properly seated.

### 2. M4MC-M4ME Models

Carefully lower air horn assembly onto float bowl (holding down on air horn gasket at pump plunger location), making sure that the bleed tubes, pull-over enrichment tubes (if used), and pump plunger stem are positioned properly through the holes in the air horn gasket (Figure 69).

**NOTICE: ALL MODELS — DO NOT FORCE THE AIR HORN ASSEMBLY ONTO THE BOWL, BUT RATHER LIGHTLY LOWER IN PLACE. IF AIR HORN DOES NOT SEAT EASILY, CHECK ALIGNMENT OF AUXILIARY METERING ROD HANGER (IF USED).**

3. Install air horn to float bowl attaching screws. (Early models have (9), late models have (13), see Figure 70). The (2) long screws go through the secondary side of the air horn at rear and (2) countersunk screws go inside primary bores next to venturi. Install air valve lockout guard (if used) under intermediate length screw (#4 in Figure 70) and secure with self-tapping screw. If used, install air horn baffle (secondary side) beneath #3 and #4 air horn screws. Air horn screws (except countersunk screws) may or may not use lockwashers dependent upon application. Tighten all screws evenly and securely (see Figure 70 for proper tightening sequence).

**NOTICE: Do not install air horn screw #5 on M4MC-M4ME models using a bowl vent valve until completion of bowl vent valve adjustment. Then, install bowl vent valve spring, gasket, and cover, retaining with #5 air horn screw. On 4MV models using the vacuum operated vent switch valve, do not install #5 air horn screw until valve cover is installed (see Step 7, Page 41).**

4. On 4MC-M4MC-M4ME models, install front vacuum diaphragm rod into the slot in lever on the end of the air valve shaft. Then, install other end of rod into hole in the front vacuum break diaphragm plunger. Install front vacuum break diaphragm and bracket assembly to float bowl (4MC) or air horn (M4MC-M4ME) and retain with two screws. Tighten screws securely.



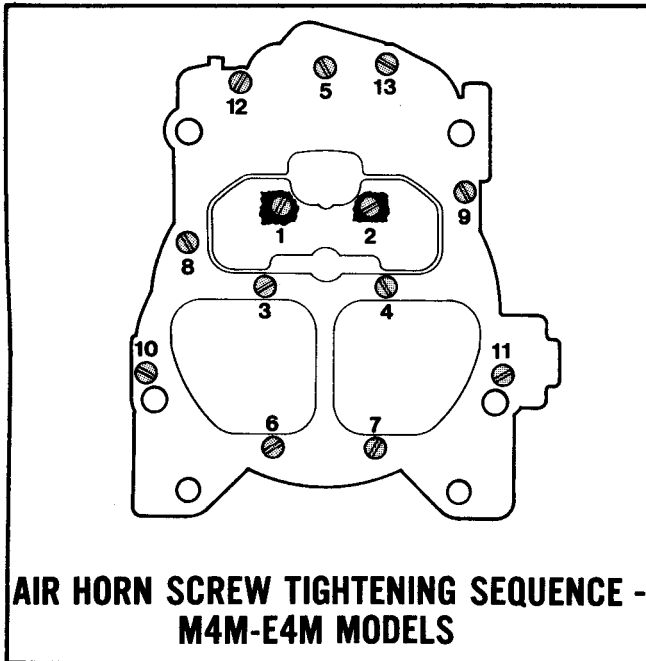

Figure 70 Air Horn Screw Tightening Sequence

**NOTICE:** Do not attach vacuum break hose until vacuum break adjustment is completed.

5. 4MV Models - Connect choke rod into lower choke lever inside bowl cavity. Then install upper end of rod into upper choke lever and retain rod in upper lever with clip.

On other models using the "clipless" rod design, connect choke rod into choke lever inside bowl cavity; then install upper end of rod into upper choke lever. Install upper choke lever on end of choke shaft, aligning slots in lever with slots on end of shaft, and install attaching screw. Tighten screw securely. If an air valve lockout lever is used, make sure tang on upper choke lever is located beneath tang on air valve lockout lever before tightening screw.

**NOTICE:** Make sure that the flats on the end of the choke shaft align with the slot in the choke lever.

6. If used, install idle vent valve on locating pins after engaging with actuating wire. Install attaching screw and tighten securely.

**NOTICE:** Some models use a thermostatically controlled idle vent valve. On these, install the thermostatic bi-metal strip first, then the spring arm on top to the bi-metal strip. Then install attaching screw. Install dust cover under air horn screw.

7. On models using a vacuum operated vent switch valve, carefully install diaphragm and stem in diaphragm retainer; then install diaphragm and retainer in air horn,

making sure diaphragm is not wrinkled or torn. Lightly tap diaphragm retainer into air horn assembly until fully seated. Install diaphragm spring over diaphragm stem and, with stem raised, compress spring while sliding vent valve assembly under slot in diaphragm stem.

**NOTICE:** Part number and "RP" on vent valve face upward. Install vent valve cover gasket, cover, and screw. Align cover with holes in air horn and tighten screw securely. Install longer air horn screw in vent valve cover and air horn and tighten screw securely. Install pump override lever on diaphragm stem and retain with small screw. Tighten screw securely.

8. Install (2) secondary metering rods into the secondary metering rod holder (upper ends of rods point toward each other). Install secondary metering rod holder (with rods positioned in secondary metering discs) onto air valve cam follower. Install retaining screw and tighten securely. Work air valves up and down several times to make sure they are free in all positions.

9. Connect upper end of pump rod to pump lever. If two hole pump lever is used, make sure pump rod is in specified hole in lever, noted at disassembly (or see specifications). Place pump lever on air horn casting — aligning hole in pump lever with hole in horn casting. Using screwdriver, push pump lever roll pin back through casting until end of pin is flush with casting bosses in air horn (Figure 71).

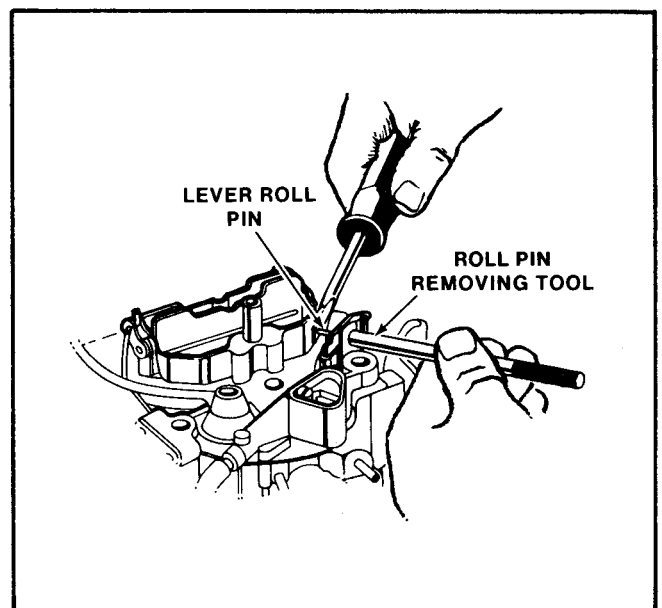

Figure 71 Installing Pump Lever

**NOTICE:** Use care installing the small roll pin to prevent damage to pump lever casting bosses.

**NOTICE:** If the "clipless" pump rod design



is not used, install pump rod in pump lever and retain with clip.

**NOTICE:** The front vacuum break, rear vacuum break (if used), and fast idle cam (choke rod) adjustments must be performed, and the thermostatic coil lever inside the choke housing has to be indexed properly before installing the choke thermostatic coil and cover assembly, and gasket (if used). Refer to the adjustment procedures and specifications contained in Section "D" of the Delco Carburetor Parts and Service Manual (9X).

10. After the vacuum break(s), fast idle cam, and inside thermostatic coil lever are adjusted, install front and rear (if used) vacuum break hoses. Then, the thermostatic coil and cover assembly, and gasket (if used), should be installed and the cover assembly rotated until the choke valve just closes. At this point, the index cover should be adjusted. Install three choke cover retainers, and screws where used, and tighten securely.

On late model carburetors where tamper resistant rivets and retainers were removed during disassembly, (and after the inside coil lever, fast idle cam, choke rod, and front and rear vacuum break adjustments have been checked), install the cover and coil assembly in choke housing by following the instructions supplied in new choke cover retaining kit.

**NOTICE:** On M4ME models, ground contact for the electric choke is provided by a metal plate located at the rear of the choke assembly. **DO NOT INSTALL A CHOKE COVER GASKET BETWEEN THE ELECTRIC CHOKE ASSEMBLY AND THE CHOKE HOUSING.**

11. If the C.E.C. valve or idle stop solenoid was removed from the bracket for replacement purposes, install solenoid in bracket, lockwasher, and retaining nut. Tighten nut securely, making sure lockwasher tabs align with slots in bracket and flats on hex portion of solenoid nut. Then, bend back tabs to retain the nut.

If mounting bracket was removed from the air horn

for replacement purposes, install solenoid and bracket assembly on locating lugs on air horn. Then, install screw securing solenoid bracket to float bowl. Tighten screw securely. Then crimp bracket tabs on air horn. Install vacuum hose from tube on float bowl to C.E.C. valve.

12. On other models, install (2) screws in bracket to retain the idle speed solenoid, A/C idle speed solenoid, throttle closing dashpot, or throttle lever actuator to the float bowl. Tighten screws securely.

**NOTICE:** Whenever a service replacement throttle body is installed on 4MV-4MC models equipped for exhaust emission control (except 4MV Pontiac), the following adjustment procedures must be performed carefully:

- a. With carburetor assembled, place a .300" plug gauge or drill in forward vent tube in air horn. With slight downward pressure on plug gauge or drill, seat power piston.
- b. Using screwdriver, back APT screw in throttle body OUT until power piston is completely seated.
- c. From this position, turn APT screw inward until power piston starts to move upward.
- d. From this point, turn APT screw in the specified number of turns listed on the instruction sheet included in the service replacement throttle body package.
- e. After adjustment, remove plug gauge or drill from air horn and install welch plug (furnished with throttle body) over APT screw.

## ADJUSTMENT PROCEDURES AND SPECIFICATIONS

Refer to the Delco Carburetor 9X Manual "C" Section for Replacement Parts and "D" Section for Trouble Shooting, Adjustment Procedures and Specifications, for each carburetor model. The adjustments should be performed in sequence listed as applicable to each carburetor model.

The 9X Manual, Carburetor Tools and Gages, are available through AC-Delco suppliers.



TYPICAL EXPLODED VIEW — QUADRAJET

PARTS

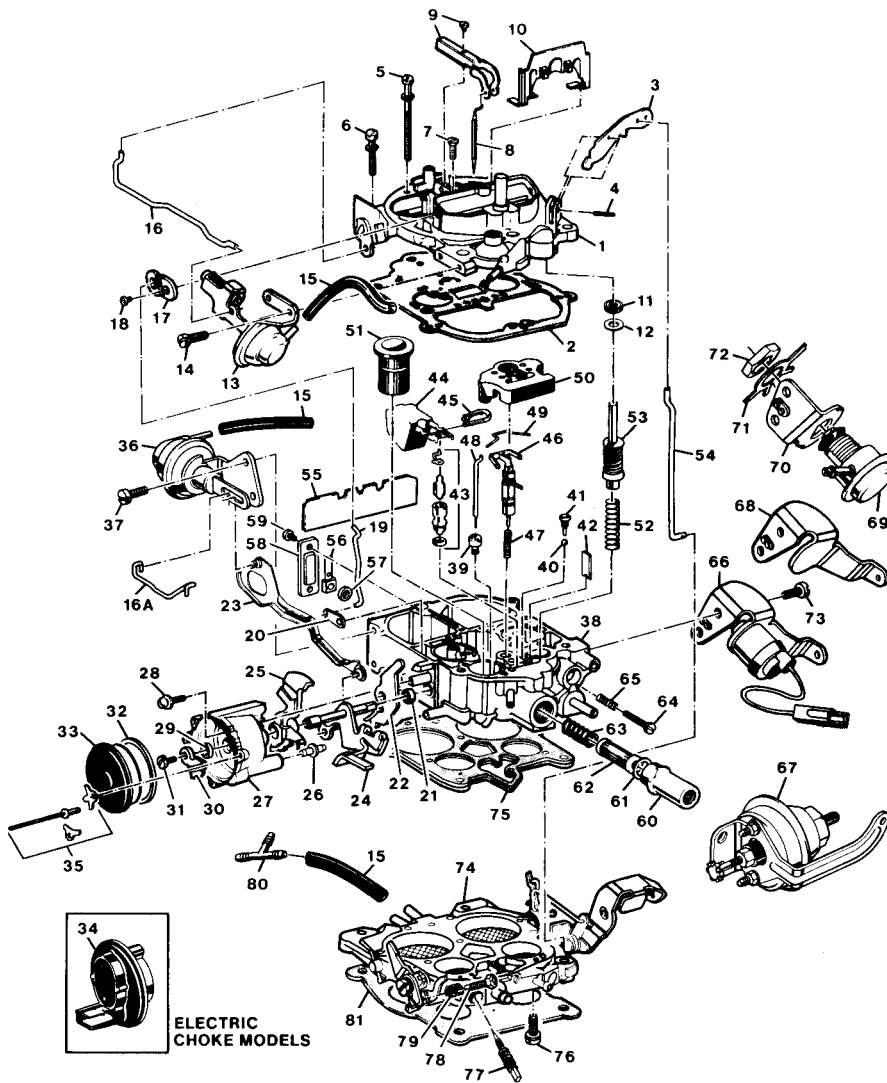

ELECTRIC  
CHOKE MODELS

- Air Horn Parts**
- 1 Air Horn Assembly
- 2 Gasket-Air Horn to F/B
- 3 Lever-Pump Actuating
- 4 Roll Pin-Pump Lever Hinge
- 5 Screw-Air Horn to T/B (Long)
- 6 Screw-Air Horn to F/B (Short)
- 7 Screw-Air Horn to F/B Countersunk)
- 8 Metering Rod-Secondary
- 9 Holder and Screw-Secondary Metering Rod
- 10 Baffle-Air Horn
- 11 Seal-Pump Stem
- 12 Retainer-Pump Stem Seal
- Choke Parts**
- 13 Vacuum Break Cont & Brkt Asm (Prim)
- 14 Screw-Vacuum Break Attaching
- 15 Hose-Vacuum Break
- 16 Link-Air Valve
- 16A Link-Air Valve (Truck)
- 17 Lever-Choke (Upper)
- 18 Screw-Choke Lever Atch
- 19 Link-Choke
- 20 Lever-Inter Choke Shaft (lower)
- 21 Seal-Inter Choke Shaft (Hot Air Choke)
- 22 Lever-Secondary Throttle Lockout
- 23 Link-Rear Vacuum Break
- 24 Inter Choke Shaft & Lever Asm
- 25 Cam-Fast Idle
- 26 Seal-Choke Hsg to F/B (Hot Air Choke)
- 27 Choke Housing Asm.
- 28 Screw-Choke Housing to F/B Atch
- 29 Seal-Inter Choke Shaft (Hot Air Choke)
- 30 Lever-Choke Coil
- 31 Screw-Choke Coil Lever
- 32 Gasket-Stat Cover (Hot Air Choke)
- 33 Choke Cover & Coil Asm (Hot Air Choke)
- 34 Choke Cover & Coil Asm (Electric Choke)
- 35 Kit-Stat Cover Attaching
- 36 Rear Vacuum Break Cont & Brkt Asm/Secd
- 37 Screw-Vacuum Break Cont Attaching
- Float Bowl Parts**
- 38 Float Bowl Assembly
- 39 Primary Metering Jet Asm
- 40 Ball-Pump Discharge
- 41 Retainer-Pump Discharge Ball
- 42 Baffle-Pump Well
- 43 Needle & Seat Assembly
- 44 Float & Lever Assembly
- 45 Hinge Pin-Float Assembly
- 46 Power Piston Assembly
- 47 Spring-Power Piston
- 48 Rod-Primary Metering
- 49 Spring-Metering Rod Retainer
- 50 Insert-Float Bowl
- 51 Insert-Aneroid Cavity
- 52 Spring-Pump Return
- 53 Pump Plunger Assembly
- 54 Link-Pump Plunger
- 55 Baffle-Secondary Bores
- 56 Idle Compensator Assembly
- 57 Seal-Idle Compensator
- 58 Cover-Idle Compensator
- 59 Screw-Idle Compensator Cover
- 60 Filter Nut-Fuel Inlet
- 61 Gasket-Filter Nut
- 62 Filter-Filter Inlet
- 63 Spring-Fuel Filter
- 64 Screw-Throttle Stop
- 65 Spring-Throttle Stop Screw
- 66 Idle Solenoid & Bracket Assembly
- 67 Idle Load Compensator & Bracket Assembly
- 68 Bracket-Throttle Return Spring
- 69 Actuator-Throttle Lever (Truck Only)
- 70 Bracket-Throttle Lever Actuator (Truck Only)
- 71 Washer-Actuator Nut (Truck Only)
- 72 Nut-Actuator Attaching (Truck Only)
- 73 Screw-Bracket Attaching
- Throttle Body Parts**
- 74 Throttle Body Assembly
- 75 Gasket-Throttle Body to F/B
- 76 Screw-Throttle Body to F/B
- 77 Idle Needle & Spring Assembly
- 78 Screw-Fast Idle Adjusting
- 79 Spring-Fast Idle Screw
- 80 Tee-Vacuum Hose
- 81 Gasket-Insulator Flange

Figure 72 Typical Quadrajets Assembly

# QUADRAJET Carburetor

## Models 4MV-4MC-M4ME-M4MC Service Manual

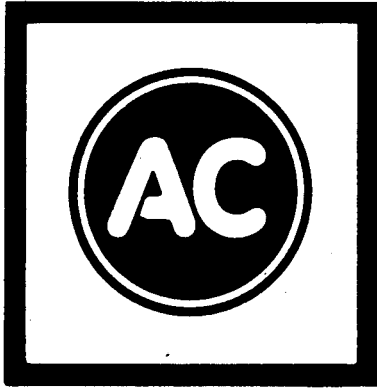



# Delco Carburetor

MODEL 4MC QUADRAJET

1973-76 GMC MOTOR HOME

455 CUBIC INCH OLDS ENGINE

BULLETIN: 9C-4000  
 DATE: NOVEMBER, 1975  
 PAGE: 1  
 REPLACES 9C-4000  
 DATED JANUARY 1975

PARTS SHOWN ARE FOR IDENTIFICATION ONLY. CONSULT PARTS LIST FOR CORRECT PART NAME AND NUMBER

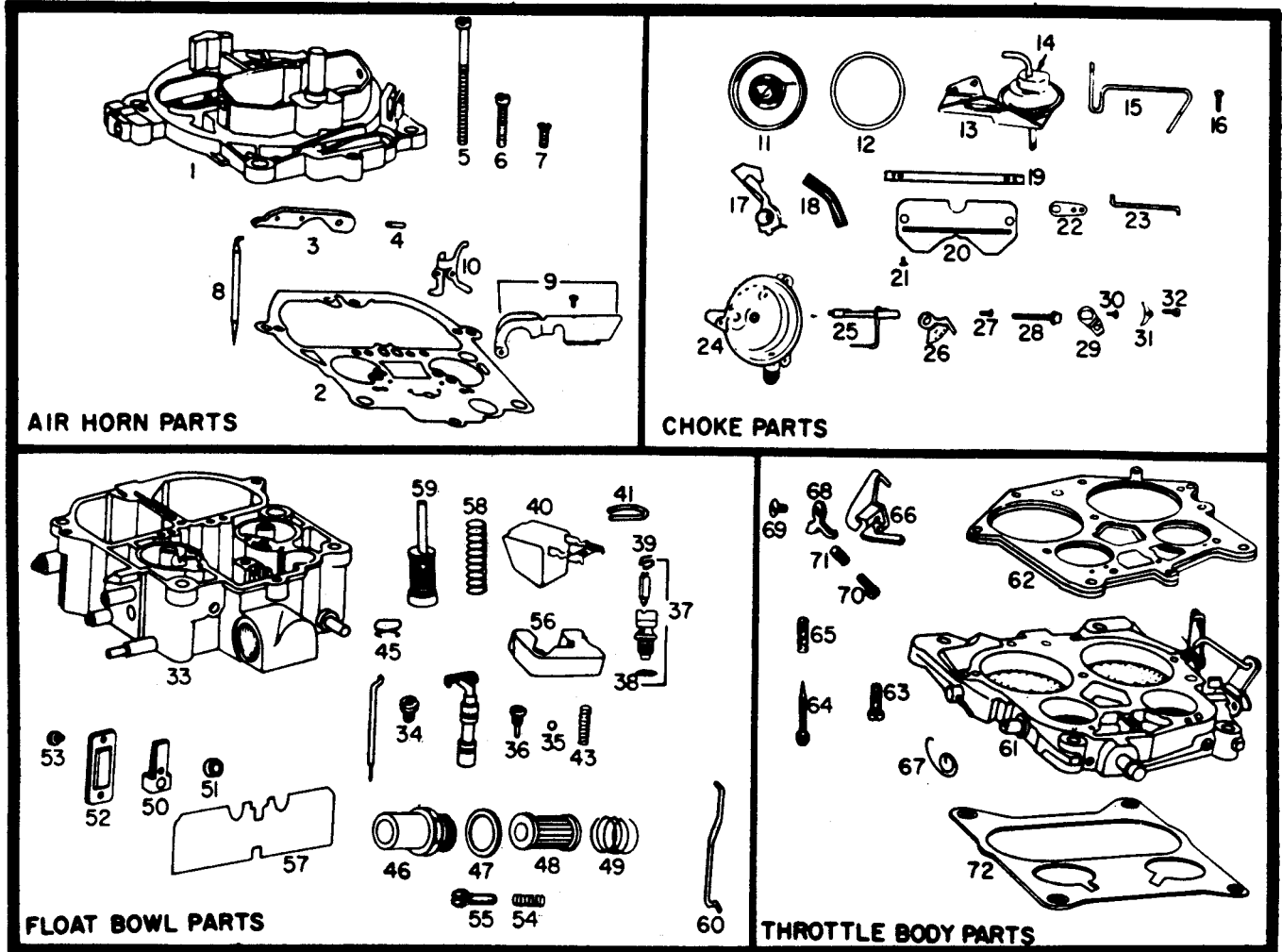

PARTS IN ALL COLUMNS SAME — EXCEPT WHERE INDICATED

Illus. No.	1975-76			APPLICATION
	1973-74	FED	CALIF.	
	7043254	7045254	7045554	CARBURETOR No.
	24-404	24-405	24-406	REPLACEMENT PACKAGE No.
	7046812	17051886	17051886	OVERHAUL KIT
	9258	9269	9269	POWER CARBURETOR KIT
	40-419	40-428	40-428	GASKET SET
<b>AIR HORN PARTS</b>				
1	7047976	7047976	17051386	Air Horn Assembly
2	7029087			Gasket—Air Horn
3	7048169			Lever—Pump Actuating
4	9428787			Roll Pin—Pump & Lockout Lever Hinge
5	7029912			Screw—Air Horn
6	7014699			Screw—Air Horn
7	7031105			Screw—Air Horn
8	7045780			Metering Rod—Secondary
9	7034522			Sec. Metering Rod Holder Kit
	7037968			Lever—Air Valve Lockout
	7035344			Air Valve Spring & Cam Kit
	7030753			Air Valve Stop

	7043254	7045254	7045554	CARBURETOR No.
CHOKE PARTS				
Illus. No.				
11	7036881			Stat Cover, Coil & Gasket Assy.
12	7002760	17050961	17050961	Gasket—Stat Cover
13	7047499			Vacuum Break Control & Brkt. Assy.
14	7040031			Vacuum Break Control Assy.
15	7038305			Rod—Vacuum
16	7038581			Screw—Control Attaching
17	7035199			Cam—Fast Idle
18	7026339			Hose—Vacuum
19	7038259			Choke Shaft
20	7045555			Choke Valve
21	7029866			Screw—Choke Valve
22	7031231			Lever—Intermediate Choke
23	7038269			Rod—Choke
24	7036880			Choke Housing Assembly
25	7038282			Inter. Choke Shaft & Lever Assy.
—	7037569			Seal—Inter. Choke Shaft
—	7030662	7043367	7043367	Seal—Choke Hsg. to Bowl
26	7038285			Lever—Stat Coil
27	7019709			Screw—Coil Lever
28	7038808			Screw—Choke Hsg. to Bowl
29	7038301			Lever—Choke
30	7029866			Screw—Choke Lever
31	7000614			Retainer—Stat Cover
32	7011270			Screw—Stat Cover
FLOAT BOWL PARTS				
33	7046757			Float Bowl Assembly
34	7031970	7031970	7031968	Jet—Primary
35	7002117			Ball—Pump Discharge
36	7029849			Retainer—Pump Discharge Ball
37	30-142			Needle & Seat Assy.
38	KIT ONLY			Gasket—Needle Seat
39	7033751			Pull Clip—Float Needle
40	7033752			Float Assembly
41	7029856			Hinge Pin—Float Assembly
42	7034903			Power Piston Assembly
43	7036019			Spring—Power Piston
44	7046338			Metering Rod—Primary
45	7029862			Spring—Metering Rod—Primary
46	7045878			Filter Nut—Fuel Inlet
47	7024281			Gasket—Filter Nut
48	GF-141			Filter—Fuel Inlet
49	7032732			Spring Fuel Filter
50				Idle Compensator Assembly
51	—			Gasket—Idle Compensator
52	—			Cover—Idle Compensator
53	—			Screw—Cover Attaching
54	7003176			Spring—Idle Stop Screw
55	7002121			Screw—Idle Stop
56	7034361			Insert—Float Bowl
57	7031365			Baffle—Float Bowl
58	7004597	7041169	7041169	Spring—Pump Return
59	7035031			Pump Assembly
60	7026138			Rod—Pump
THROTTLE BODY PARTS				
61	7046811	17052803	17051396	Throttle Body Assembly
62	KIT ONLY			Gasket—Throttle Body
63	7035790			Screw—Throttle Body
64	7048532			Idle Needle
65	7011479			Spring—Idle Needle
66	7038298			Lever—Cam Follower
67	7035772			Spring—Cam Lever
68	7035998			Fast Idle Lever
69	7035523			Screw—Fast Idle Lever
70	7044794			Screw—Fast Idle Adjusting
71	7029900			Spring—Fast Idle Screw
72	412501	419047	419047	Gasket—Flange



# Delco Carburetor

MODEL M4MC QUADRAJET  
1977 GMC MOTOR HOME  
403 CUBIC INCH OLDS ENGINE

BULLETIN: 9C-4001  
DATE: NOVEMBER 1977  
PAGE: 1  
REPLACES 9C-4001  
DATED NOVEMBER 1976

PARTS SHOWN ARE FOR IDENTIFICATION ONLY. CONSULT PARTS LIST FOR CORRECT PART NAME AND NUMBER

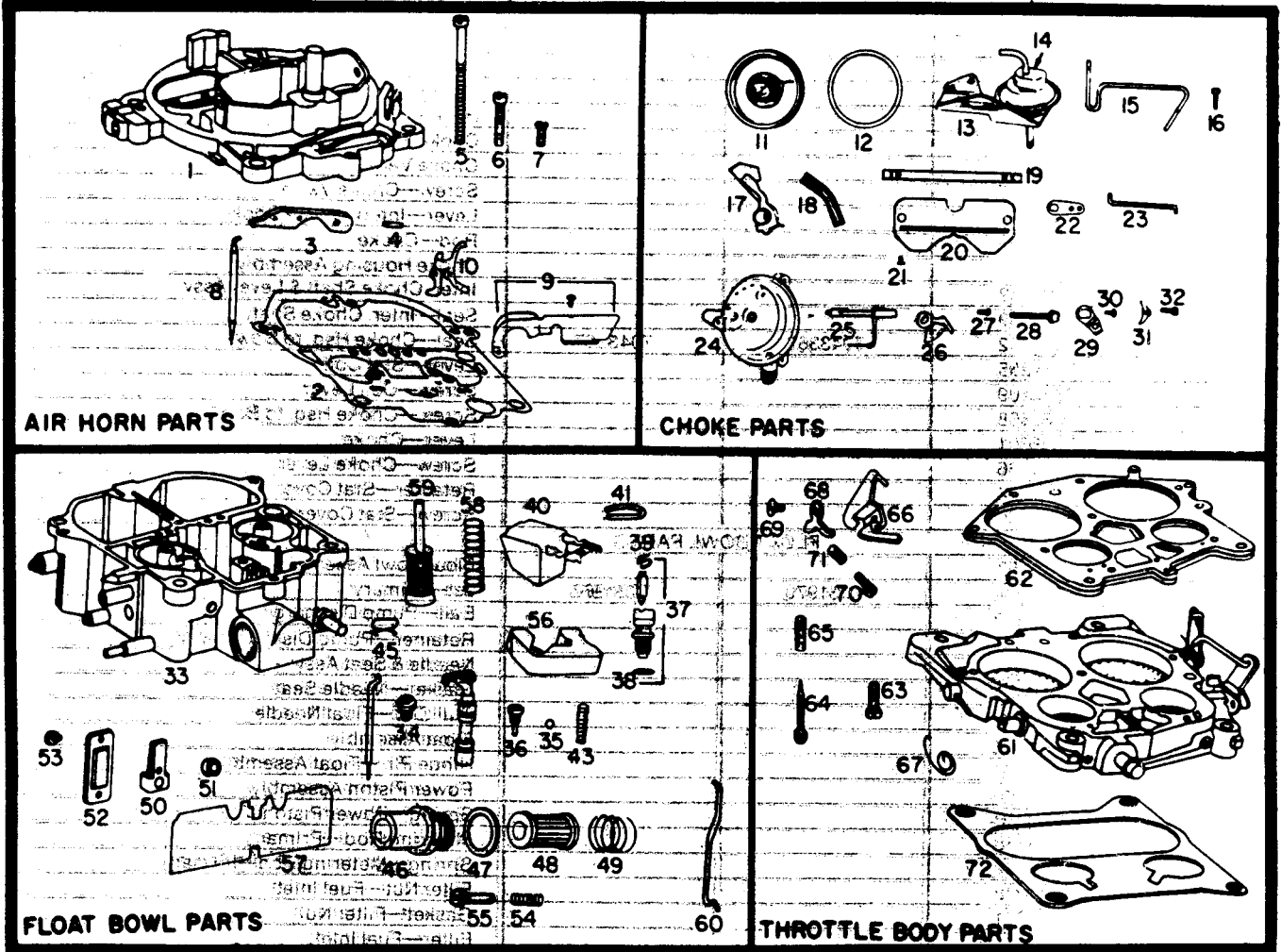

PARTS IN ALL COLUMNS SAME — EXCEPT WHERE INDICATED

	FEDERAL	CALIFORNIA	APPLICATION
	17057254	17057559	CARBURETOR No.
	24407	24411	REPLACEMENT PACKAGE No.
	17056499	17055923	OVERHAUL KIT
	9319	9319	POWER CARBURETOR KIT
	40-454	40-454	GASKET SET
Illus. No.	AIR HORN PARTS		
1	17055497	17055919	Air Horn Assembly
2	17051797		Gasket—Air Horn
3	7048169		Lever—Pump Actuating
4	9428787		Roll Pin—Pump & Lockout Lever Hinge
5	7029912		Screw—Air Horn
6	7014699		Screw—Air Horn
7	7031105		Screw—Air Horn
8	7045780		Metering Rod—Secondary
9	7034522		Sec. Metering Rod Holder Kit
10	—	—	Lever—Air Valve Lockout
—	7035344		Air Valve Spring & Cam Kit
—	—	—	Air Valve Stop



Illus. No.	17057254	17057559	CARBURETOR No.
	<b>CHOKE PARTS</b>		
11	17054309		Stat Cover, Coil & Gasket Assy.
12	17050961		Gasket-Stat Cover
13	7044435		Vacuum Break Control & Bracket Assy.
14			Vacuum Break Control Assy.
15	7041527		Rod-Vacuum
16	17050732		Screw-Control Attaching
17	17056631	17056632	Cam-Fast Idle
18	7026339		Hose-Vacuum
19	7038259		Choke Shaft
20	7048904		Choke Valve
21	7029866		Screw-Choke Valve
22	7031231		Lever-Intermediate Choke
23	7041472		Rod-Choke
24	17055095	17055922	Choke Housing Assembly
25	7041492		Intermediate Choke Shaft & Lever Assy.
-	7037569		Seal-Intermediate Choke Shaft
-	7043367		Seal-Choke Hsg. to Bowl
26	7043368		Lever-Stat Coil
27	7019709		Screw-Coil Lever S
28	7038808		Lever-Choke Hsg. to Bowl
29	7041542		Lever-Choke
30	7029866		Screw-Choke Lever
31	7000614		Retainer-Stat Cover
32	7011270		Screw-Stat Cover
	<b>FLOAT BOWL PARTS</b>		
33	17055498	17055921	Float Bowl Assembly
34	7031975	7031978	Jet-Primary
35	7002117		Ball-Pump Discharge
36	7029849		Retainer-Pump Discharge Ball
37	30134		Needle & Seat Assy.
38	KIT ONLY		Gasket-Needle Seat
39	7033751		Ball Clip-Float Needle
40	7046300		Float Assembly
41	7041469		Hinge Pin-Float Assembly
42	7044449		Power Piston Assembly
43	7036019	17055329	Spring-Power Piston
44	17056955	17051353	Metering Rod-Primary
45	7041459		Spring-Metering Rod-Primary
46	7044951		Filter Nut-Fuel Inlet
47	7024281		Gasket-Filter Nut
48	7032732		Filter-Fuel Inlet
49			Spring Fuel Filter
50			Idle Compensator Assembly
51			Gasket-Idle Compensator
52			Cover-Idle Compensator
53			Screw-Cover Attaching
54	7003176		Spring-Idle Stop Screw
55	7002121		Screw-Idle Stop
56	7041471		Insert-Float Bowl
57	7031365		Baffle-Float Bowl
58	7042979		Spring-Pump Return
59	17053072		Pump Assembly
60	7026138		Rod-Pump
-	7044330		Insert-Aneroid Cavity
-	7041473		Lever-Secondary Lockout
	<b>THROTTLE BODY PARTS</b>		
61	17058885	17054744	Throttle Body Assembly
62	KIT ONLY		Gasket-Throttle Body
63	7035790		Screw-Throttle Body
64	7048532		Idle Needle
65	7011479		Spring-Idle Needle
66	7041497		Lever-Cam Follower
67	17051494		Spring-Cam Lever
68	7041498		Fast Idle Lever
69	7036079		Screw-Fast Idle Lever
70	7044794		Screw-Fast Idle Adjusting
71	7029900		Spring-Fast Idle Screw
72	419047		Gasket-Flange



# Delco Carburetor

MODEL M4MC QUADRAJET

1978 GMC MOTOR HOME  
403 CUBIC INCH OLDS ENGINE

SHEET NO: 9C-4002  
DATE: NOVEMBER 1977  
PAGE: 1

PARTS SHOWN ARE FOR IDENTIFICATION ONLY, CONSULT PARTS LIST FOR CORRECT PART NAME AND NUMBER

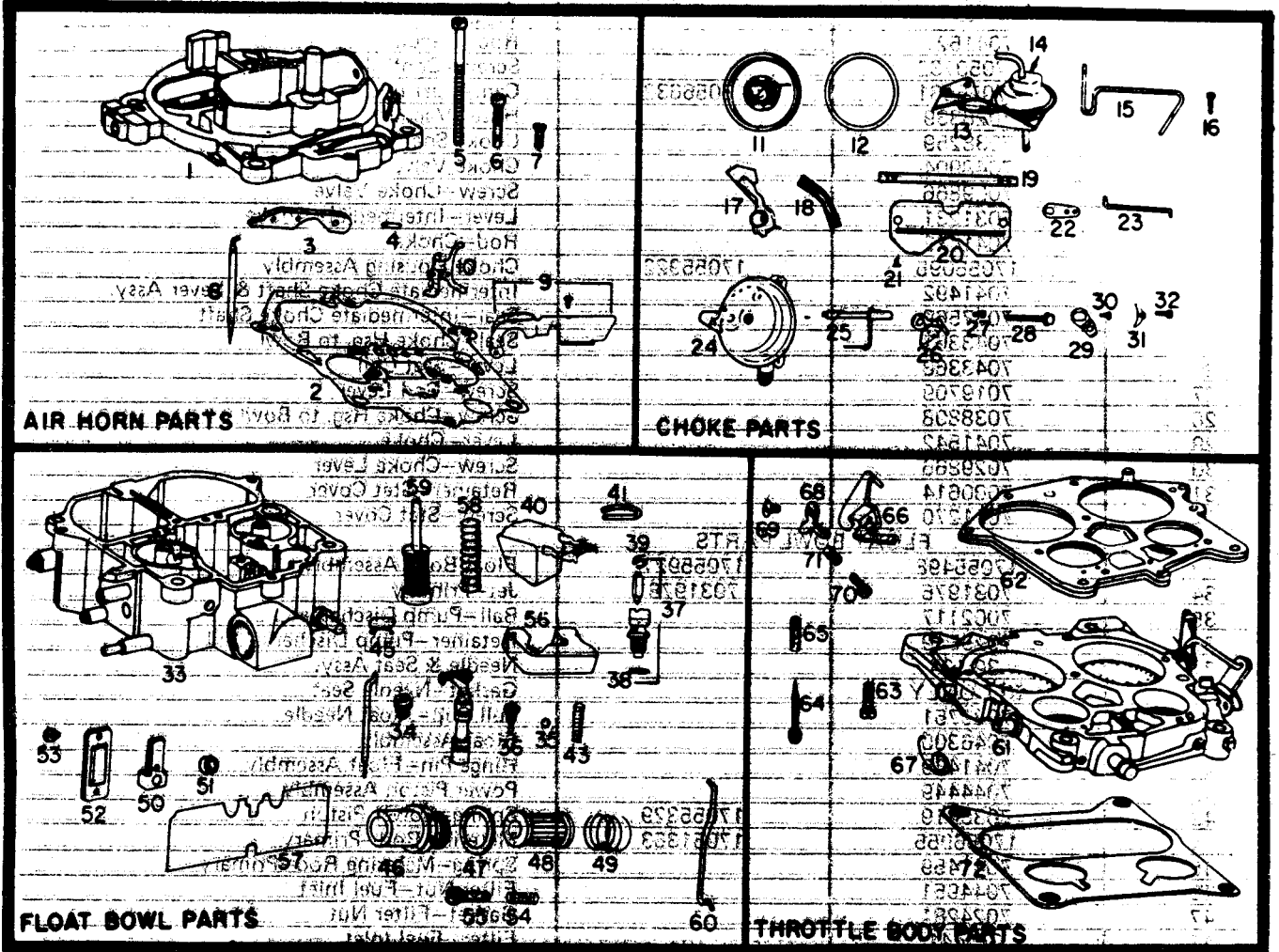

PARTS IN ALL COLUMNS SAME — EXCEPT WHERE INDICATED

	FEDERAL	CALIFORNIA	APPLICATION
	17058264	17058559	CARBURETOR NO.
	24-409	24-410	REPLACEMENT PACKAGE No.
	17055634	17065041	OVERHAUL KIT
	9341		POWER CARBURETOR KIT
	40-466		GASKET SETS
Illus. No.	AIR HORN PARTS		
1	17055632	17065038	Air Horn Asser
2	17056357		Gasket—Air Horn
3	7048169		Lever—Pump Actuating
4	9428787		Roll Pin—Pump & Lockout Lever Hinge
5	7029912		Screw—Air Horn
6	7014699		Screw—Air Horn
7	7031105		Screw—Air Horn
8	7045780		Metering Rod—Secondary
9	7034522		Sec. Metering Rod Holder Kit
10	—	—	Lever—Air Valve Lockout
—	7035344	—	Air Valve Spring & Cam Kit
—	—	—	Air Valve Stop

	17058254	17058559	CARBURETOR No.
Illus. No.	CHOKE PARTS		
11	17054309		Stat Cover, Coil & Gasket Assy.
12	17050961		Gasket—Stat Cover
13	7044435		Vacuum Break Control & Bracket Assy.
14	—	—	Vacuum Break Control Assy.
15	7041527		Rod-Vacuum
16	17050732		Screw—Control Attaching
17	17056631	17056632	Cam—Fast Idle
18	7026339		Hose—Vacuum
19	7038259		Choke Shaft
20	7048904		Choke Valve
21	7029866		Screw—Choke Valve
22	7031231		Lever—Intermediate Choke
23	7041472		Rod—Choke
24	17055613	17065040	Choke Housing Assembly
25	17050754		Intermediate Choke Shaft & Lever Assy.
—	7037569		Seal—Intermediate Choke Shaft
—	7043367		Seal—Choke Hsg. to Bowl
26	7043368		Lever—Stat Coil
27	7019709		Screw—Coil Lever
28	7038808		Screw—Choke Hsg. to Bowl
29	7041542		Lever—Choke
30	7029866		Screw—Choke Lever
31	7000614		Retainer—Stat Cover
32	7011270		Screw—Stat Cover
	FLOAT BOWL PARTS		
33	17055633	17065039	Float Bowl Assembly
34	7031974	7031978	Jet—Primary
35	7002117		Ball—Pump Discharge
36	7029849		Retainer—Pump Discharge Ball
37	30-134		Needle & Seat Assy.
38	KIT ONLY		Gasket—Needle Seat
39	7033751		Pull Clip—Float Needle
40	7046300		Float Assembly
41	7041469		Hinge Pin—Float Assembly
42	7044449		Power Piston Assembly
43	7036019	17055329	Spring—Power Piston
44	17056953	17051353	Metering Rod—Primary
45	7041459		Spring—Metering Rod—Primary
46	17059861		Filter Nut—Fuel Inlet
47	7024281		Gasket—Filter Nut
48	GF-441		Filter—Fuel Inlet
49	7032732		Spring Fuel Filter
50	—		Idle Compensator Assembly
51	—		Gasket—Idle Compensator
52	—		Cover—Idle Compensator
53	—		Screw—Cover Attaching
54	7003176		Spring—Idle Stop Screw
55	7002121		Screw—Idle Stop
56	7041471		Insert—Float Bowl
57	7031365		Baffle—Float Bowl
58	7042979		Spring—Pump Return
59	17053072		Pump Assembly
60	7026138		Rod—Pump
—	17051796		Insert—Aneroid Cavity
—	7041473		Lever—Secondary Lockout
	THROTTLE BODY PARTS		
61	17058648	17058984	Throttle Body Assembly
62	KIT ONLY		Gasket—Throttle Body
63	7035790		Screw—Throttle Body
64	7048532		Idle Needle
65	7011479		Spring—Idle Needle
66	7041497		Lever—Cam Follower
67	17051494		Spring—Cam Lever
68	7041498		Fast Idle Lever
69	7036079		Screw—Fast Idle Lever
70	7044794		Screw—Fast Idle Adjusting
71	7029900		Spring—Fast Idle Screw
72	419047		Gasket—Flange