



Motor Home

OPERATING MANUAL

EFFECTIVE WITH

VEHICLE IDENTIFICATION NUMBER

TZE165V100893

date
we

IMPORTANT
OPERATING
SAFETY AND
MAINTENANCE
INSTRUCTIONS

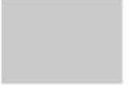

A Word To The GMC MotorHome Owner

Congratulations on your purchase of a GMC MotorHome. You have opened the way to an endless variety of happy holidays.

This manual has been prepared to acquaint you with the operation and maintenance of your MotorHome, and to provide important safety information. It is supplemented by convenient folders which provide additional information on vehicle maintenance, emission control, and warranties. We urge you to read these publications carefully and follow the recommendations to help assure the most enjoyable and troublefree operation of your vehicle.

When it comes to service, remember that your GMC MotorHome Dealer knows your vehicle best and is interested in your complete satisfaction. Return to him for service and any other assistance you may require.

GMC Truck and Coach maintains a number of Zone Offices throughout the country. Should you have a problem that cannot be handled through normal channels, please follow the procedure described under the "Owner Assistance" section.

Thank you for choosing a GMC MotorHome. We extend our best wishes for many years of pleasant traveling.

Cordially,



*R. C. Stelter
General Sales Manager*

GMC MOTORHOME OPERATING MANUAL

IMPORTANT

This manual should be considered a permanent part of the vehicle and must remain with the vehicle at time of resale.

All information, illustrations and specifications contained in this manual are based on the latest product information available at the time of publication. The right is reserved to make changes at any time without notice.

For vehicles sold in Canada, substitute the name General Motors of Canada whenever the name GMC Truck & Coach Division appears in this manual.

Service Publications

**GMC TRUCK & COACH DIVISION
GENERAL MOTORS CORPORATION**

Pontiac, Michigan 48053

K H E K M
880 A A B A
M M

TABLE OF CONTENTS

SUBJECT	PAGE NO	SUBJECT	PAGE NO.
<u>Important Information on</u>			
<u>Vehicle Loading</u>	1	Speedometer and Odometer	19
<u>Before Driving Your MotorHome</u>	3	Fuel Gauge	19
Driver Checklist	3	Temperature Gauge	19
Inside Rearview Mirror	3	Oil Pressure Gauge	19
Keys	4	Charging System Warning Light	19
Seats	4	Brake System Warning Light . .	19
Entrance Door	5	Tell-Tale Warning Light Cluster	20
Lap Belts	5	Headlight Switch	21
Lap Belt Inspection	6	Windshield Wiper Lever	21
Child Restraint	6	Windshield Washers	21
Trailer Hauling	6	Fuel Selector Switch	21
Operation In Foreign Countries	7	Battery Boost Switch	21
Trip Tips	8	Cigar-Cigarette Lighter	22
Driving Tips	9	Heating System (Without Automotive Air Conditioner)	22
New Vehicle Operating Speeds.	9	Automotive Air Conditioner	23
<u>Starting and Operating Vehicle</u> . .	11	Radios and Tape Deck	24
Engine Exhaust Gas Caution	11	Mobile Radio Transmitters	25
Steering Column Controls	12	Power Level System	26
Anti-Theft Steering Column Lock . . .	12	<u>Operation of Living Area Facilities</u> . . .	29
Parking	12	Living Area Facilities Caution . . .	29
Starting Engine	12	Living Area Electrical System	29
Automatic Transmission	13	General Information	29
Turn Signals and Lane Change Feature	14	120-Volt To 12-Volt Converter and Battery Charger	29
Hazard Warning Flasher	14	External Power	30
Horn Control	14	Lighting System	30
Power Steering	14	Monitor Panel	31
Tilt Steering Wheel	15	Onan Motor Generator	31
Cruise Control	15	Living Area Water System	33
Floor Controls	16	Filling Water Tank	33
Power Brake System	16	External Water Connection	35
Headlight Dimmer Switch	18	Water Pump	35
Headlight "Flicker"	18		
Instrument Panel and Controls	19		

TABLE OF CONTENTS

SUBJECT	PAGE NO.	SUBJECT	PAGE NO.
Water Heater	36	Lap Belt Care	57
Kitchen Facilities	36	Interior Glass	57
All-Electric Refrigerator ..	36	Kitchen Sink	57
Kitchen Range/Oven	37	Vacuum Cleaner	57
Kitchen Sink and Faucet .	40	Drapery Care	58
Water Purifier	40	Cleaning Fabrics	58
Bathroom Facilities	41	Cleaning Fabrics (With Cleaning Fluids)	58
Standard Toilet	41	Cleaning Fabrics (With Detergent Foam Cleaner) .	59
Recirculating Toilet	42	Removal of Specific Stains .	59
Bathroom Sink and Shower Control Valve ...	43	Exterior Appearance Care	60
Shower Head	43	Bright Metal Parts	60
Bathroom Warm Air Duct .	43	Exterior Glass	60
Bathroom Exhaust Fan	44	Polishing and Waxing	60
Ventilation	44	Touch-Up Paint	60
Windows	44	Undercoating	60
Ceiling Vents	44	<u>Service and Maintenance</u>	61
Roof-Mounted Air Conditioner	45	Maintenance Schedule	61
Furnace	45	Accessibility	62
Furniture	48	Exterior Compartments	62
<u>In Case of Emergency</u>	51	Engine Accessibility	62
Four-Way Hazard Warning Flasher .	51	Engine Compartment Light	64
Emergency Starting	51	Hoisting Instructions	64
Jump Starting	51	Lubrication Details .	65
Engine Coolant Caution	53	Engine	65
Jack Usage Instructions	53	Transmission	67
Towing	54	Final Drive	68
Freeing Vehicle From Sand, Etc. ...	54	Steering System	68
Emergency Exit	55	Brake System .	69
Fire Extinguisher	56	Servicing Details	69
<u>Appearance Care</u> .	57	Engine Cooling System	69
Care and Cleaning of Interior	57	Engine Fuel System	71
General Information	57		

TABLE OF CONTENTS

SUBJECT	PAGE NO	SUBJECT	PAGE NO
Carburetor		Sanitizing Living Area Water System	91
Chassis Ele Sys		Winterization	
Wheels and		Vehicle Storage	92
Front Suspe	78	<u>General Data and Specifications</u>	95
ar S	79	<u>Owner Assistance</u>	103
LP Gas System	80	U.S. Zone Territories	
iving Area Electrical System	81	U.S. Zone Offices	105
Motor Generator Maintenance	8	Mexico Zone Office	105
san S	86	GM of C da Limited—Zone Offices	
Standard Toilet	86	After-Hour Information Service	
Recirculating Toilet	87	Maintenance Manual and Parts Book	
Draining Hol ng Tank	88	Fact About Gasoline Mileage	
Dr ng Living Area Wate System	89	ide:	
Wate Tank Filter	90	Gas Station Information Inside Back Cover	

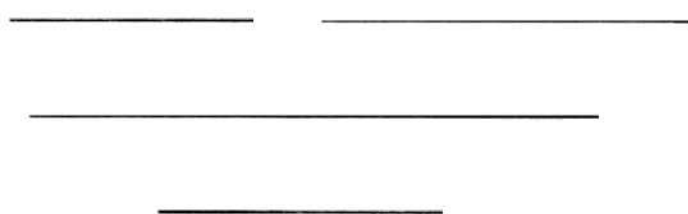

IMPORTANT INFORMATION ON VEHICLE LOADING

CAUTION

The components of your vehicle are designed to provide satisfactory service if the vehicle is not loaded in excess of either the Gross Vehicle Weight Rating (GVWR) or the maximum Front and Rear Gross Axle Weight Ratings (GAWR's) specified on the vehicle identification number plate. Overloading can create serious potential safety hazards and can also shorten the service life of your vehicle. Your dealer can advise you concerning proper loading conditions of your vehicle.

When loading the MotorHome, it is important that it is properly loaded. All items should be loaded as centrally and as low as possible. This is essential to maintain proper vehicle handling. Even though a single item may not weigh much alone, several of these items may have considerable weight. Proper loading is essential.

MAXIMUM FRONT AND REAR AXLE WEIGHTS (AS MANUFACTURED)

The weight of the load must be properly distributed over both the front and rear axles, although not necessarily evenly. The plate shows the maximum weight that the front axle can carry (front GAWR) and the maximum weight that the rear axle (rear GAWR) can carry. The GVWR represents the maximum permissible loaded weight of the vehicle. It is established by the manufacturer taking into consideration the engine, transmission, frame, brake, axle and tire capabilities. Actual front and rear end weights at the ground can only be determined by weighing the vehicle. This can be accomplished through highway weigh stations or other such commercial facilities. For assistance in this regard, consult your dealer. Care should also be exercised to see that the load is distributed on both sides of the centerline of the vehicle as equally as possible.

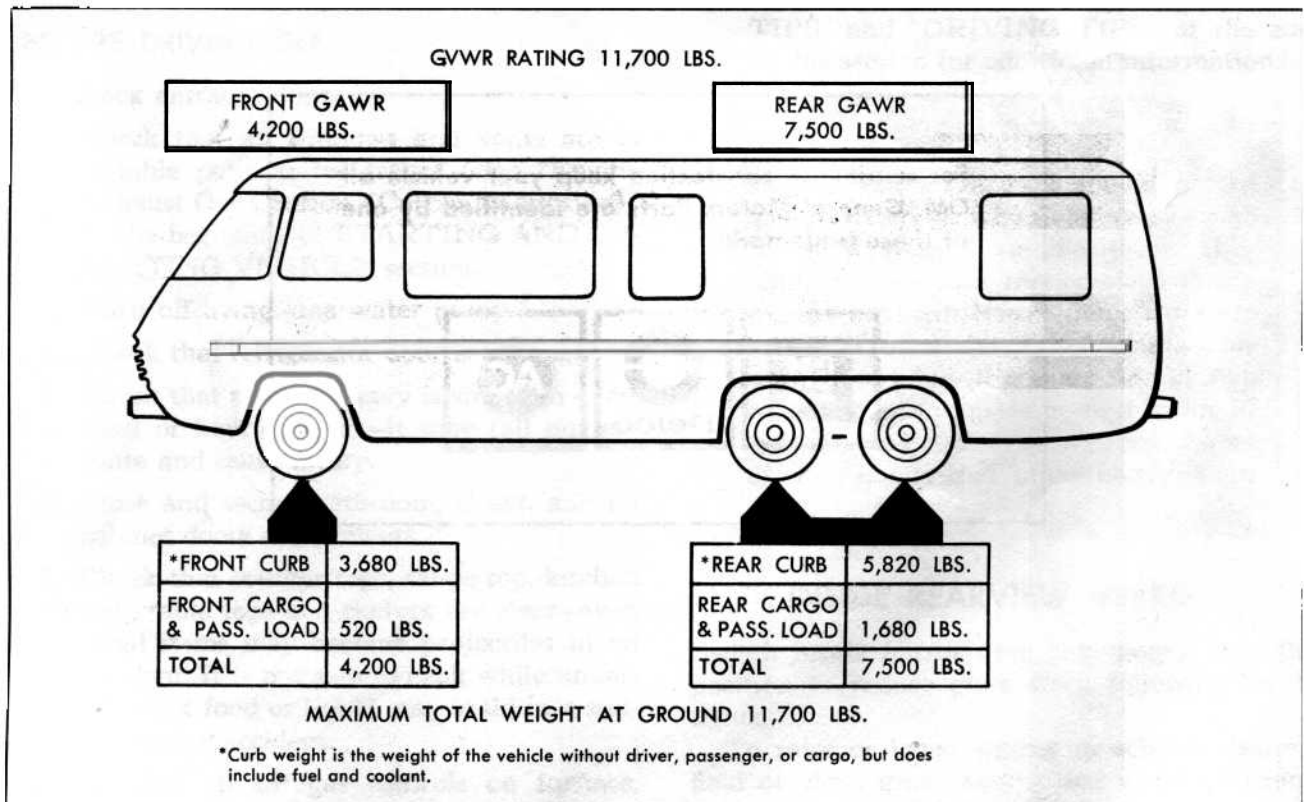

Vehicle Loading

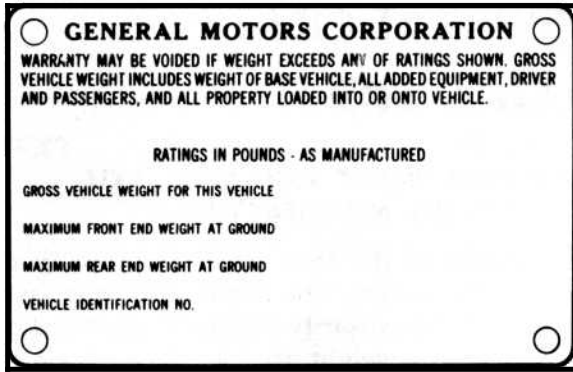

Vehicle Identification Plate

VIN (Vehicle Identification Number) Plate

The vehicle identification number plate shows the GVWR and the front and rear GAWR's for the vehicle to which they are attached.

Gross Vehicle Weight (GVW) is the weight of the vehicle itself, all items added to the vehicle after it has left the factory, the driver and all occupants, and everything that is loaded into (or onto) the vehicle. *The GVW must not exceed the GVWR and the front and rear weights*

of the loaded vehicle must not exceed the front and rear GAWR's.

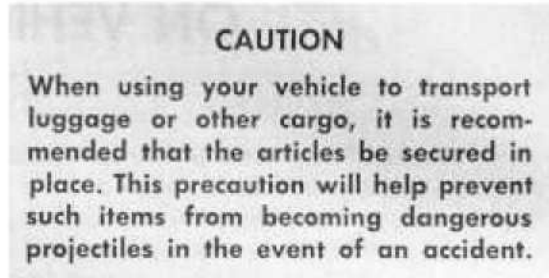

EFFECT ON WARRANTY

Your New Vehicle Warranty does not apply to any part of your vehicle "which has been subject to misuse." Any part which fails because of overloading has been subject to misuse within the meaning of this provision of the warranty.

REAR BUMPER LOADING

Care must be taken with racks or temporary attachments, when attached to the rear bumper. Such items could nullify the energy absorbing capabilities of the rear bumper. Your GMC MotorHome dealer can advise you as to suitable means of attachment.

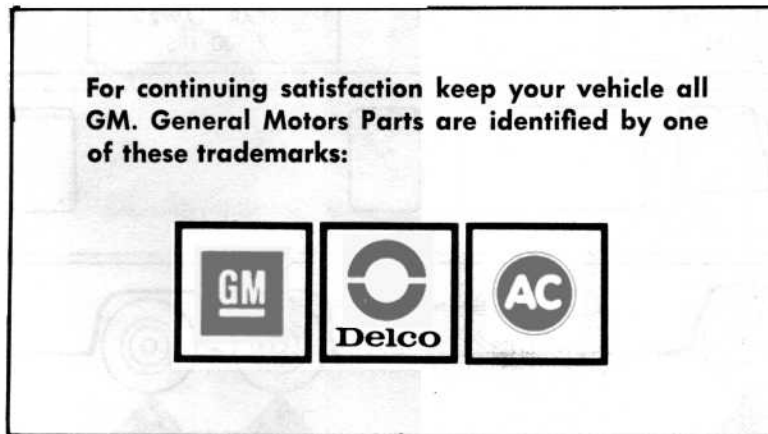

BEFORE DRIVING YOUR MOTORHOME

DRIVER CHECK LIST

BEFORE ENTERING VEHICLE

1. See that windows, mirrors, and lights are clean.
2. Check inflation condition of tires.
3. Turn off LP gas valve on LP tank (See CAUTION under "LP Gas System" in SERVICE AND MAINTENANCE section).
4. Check that sewer connection, all external compartments, and filler openings are properly stowed or closed and/or locked.
5. Check that items stored on exterior of vehicle are securely lashed.
6. Will any items stored on exterior of vehicle present a clearance problem?
7. Are there any rocks, posts, low-hanging lines or branches under or near the vehicle you must avoid before driving away?
8. Check that area to rear of vehicle is clear if about to back-up.

BEFORE DRIVING OFF

1. Lock entrance door.
2. Check that all windows and vents are in suitable position for travel (See "Engine Exhaust Gas Caution (Carbon Monoxide)" at the beginning of STARTING AND OPERATING VEHICLE section).
3. Turn off living area water pump.
4. Check that refrigerator door is fastened.
5. Check that nothing heavy is stored in overhead or high cabinets—it may fall out en-route and cause injury.
6. Close and secure bathroom, closet, and all cabinet doors and drawers.
7. Check that counter tops, range top, kitchen sink, table tops and shelves are clear—even small items may become projectiles in an accident. It is not safe to cook while underway—hot food or liquid may scald in a sudden stop or accident.
8. Be sure all LP gas controls on furnace, range/oven and optional gas/electrical refrigerator are turned off.

9. Check that all interior stowage is securely held.
10. Check that all lights and switches are set in positions suitable for travel.
11. Position driver's seat for comfort.
12. Check that driver's and front passenger's seat, and any other swivel-mounted seats are locked in position.
13. Check adjustment of inside and outside mirrors. Adjust curtains where necessary for visibility.
14. If vehicle is equipped with optional Power Level System, check that both control knobs are set to "TRAVEL" position.
15. Fasten lap belts.
16. Check that warning light bulbs light when key is turned to ON or START position.
17. With engine running, check that warning lights are now out.
18. Be sure you understand your vehicle and how to operate it and its systems safely.
19. It is recommended that you refer to "TRIP TIPS" and "DRIVING TIPS" at the end of this section for additional information.

CAUTION

Counter and table tops should not be used for storage when underway—even for light weight, small articles. They might become dangerous projectiles during an accident. Heavy items stored in overhead or waist-high cabinets may also cause injury if a sharp turn or stop causes them to topple against inside of cabinet door, forcing it open. Store canned goods and other heavy items down low.

INSIDE REARVIEW MIRROR

Switch inside mirror (see next page) to night position to reduce glare from following headlights.

To raise or lower mirror to achieve desired field of view, grasp mirror and exert sufficient pressure by pushing or pulling up, down, or sideways.

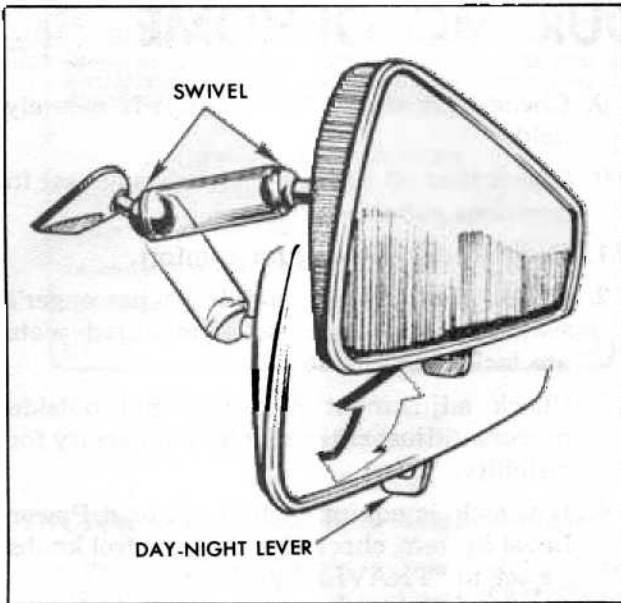

Inside Rearview Mirror



Seat Swivel Mechanism

KEYS

Two sets of keys are furnished with your vehicle. Each key has a different cross section so that it can be inserted only in certain locks.

Key with Square Head—For ignition switch only.

Key with Oval Head—For door lock, glove box and external utilities compartment.

NOTE: A third key is provided for the water tank filler door when located on rear of vehicle.

The code number of each key is stamped on the "knock out" plug in the key head. Your dealer removed these plugs and placed them with the spare set of keys in the special key envelope that was given to you at the time of delivery. For your protection:

- Record the numbers on the key envelope and discard the key plugs.
- Keep the key envelope in a safe place such as your wallet, **NOT IN THE VEHICLE.**

In the event the original keys are lost, duplicates can be made by your dealer or a locksmith using the key code information. When leaving the vehicle unattended, remove the keys and lock the entrance door.



Seat Track Mechanism

SEATS

The driver and passenger seats in the driver compartment may be adjusted to suit an individual's preference. To move seat forward or backward, simply release the seat locking lever located on the aisle side of the seat. Once released, exert slight body pressure in the direction desired. Release lever to lock the seat in the desired position.

The seats can be swiveled to provide easy entrance and exit. To turn swivel seat, release locking mechanism by moving seat swivel lever (as shown), then turn seat.

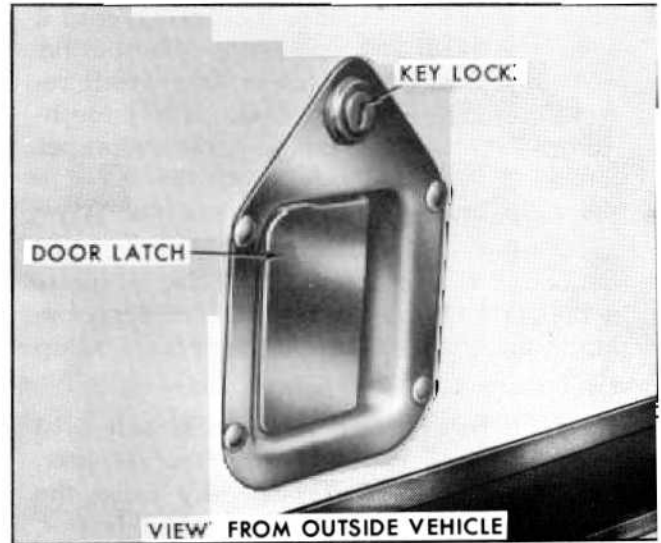
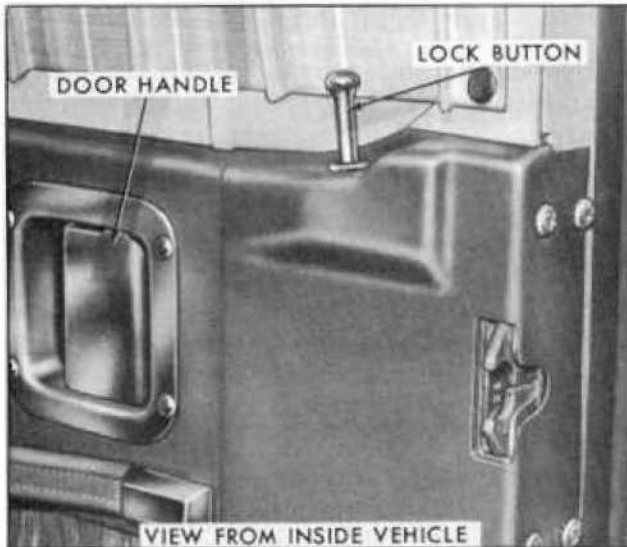

Entrance Door Latch

CAUTION

Check that all swiveling seats are locked in position before driving off. If any seat swiveled during an accident the occupant may be more likely injured. **DO NOT** adjust the driver's seat swivel or fore and aft mechanism while the vehicle is moving. The seat could move unexpectedly causing loss of control of the vehicle.

ENTRANCE DOOR

DOOR LATCH

Door must be locked from outside the vehicle by inserting the key into the door key lock and turning. To unlock, turn in the clockwise direction. Reverse the direction to lock.

To lock door from inside vehicle, push the lock button **DOWN**. To unlock and open door from the inside, pull the lock button **UP** and pull on inside door handle.

REMINDER: Always lock entrance door when driving for greater security in the event of an accident, to help keep children from inadvertently opening door, and for security against entry by unwelcome persons while momentarily stopped.

LAP BELTS

Your GMC MotorHome is equipped with lap belts in the driver and front passenger seating

position(s), as well as certain other seating locations in the MotorHome. It is recommended that while the vehicle is in motion, all occupants remain seated and keep lap belts buckled snugly at all times.

The driver and front passenger seating positions—have retractors which are designed to automatically take up excess webbing.

- Adjust seat to desired position and sit erect and well back in the seat.
- In a single motion, pull webbing across lap far enough to permit inserting metal latch

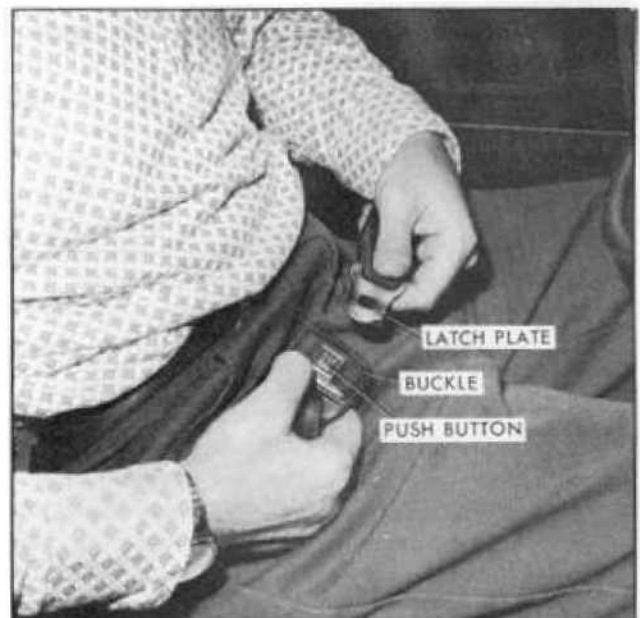

Lap Belt (Front Seating Positions)

plate end of lap belt into the buckle, until a snap is heard. If webbing is not pulled out far enough to reach the buckle, let the belt rewind into the retractor to release lock mechanism, so belt can be pulled out to the proper length.

- Position belt across lap as **LOW ON HIPS** as possible. To reduce the risk of sliding under the belt during an accident, adjust to a **SNUG FIT** by pulling belt firmly across lap in direction of retractor so it can take up slack.

NOTE: Take care not to let the lap belt twist while it is being rewound into the retractor. The bulk of the twisted belt may cause the retractor to jam so it will not rewind further, while at the same time the retractor's locking mechanism may prevent the belt from being withdrawn. If a belt should become jammed, you may be able to release it by working the belt in and out until the belt rewinds far enough to unlock. If lap belt remains jammed or other parts of the restraint system do not operate properly take the vehicle to your dealer for service.

Lap belts at seating positions other than the driver and front passenger positions—should be positioned and secured as above, and adjusted to a **SNUG FIT** by pulling on the end of the belt extending from the buckle.

- To lengthen the lap belts at these seating positions, place buckle at right angle to the belt webbing and pull on buckle; belt should then slide easily through the adjustment feature.
- To unfasten seat belts, depress push button in center of buckle.

CAUTION

A snug fit and a low lap belt position are essential to lessen the chance of injury in the event of an accident, because this spreads the force exerted by the lap belt in a collision over the strong hip bone structure rather than across the soft abdominal area. To lessen the chance of injury in the event of an accident—never use the same belt for more than one person at a time; avoid wearing belts in a twisted condition; do not allow belts or hardware to become pinched between the seat structural (metallic) member or in the door.

LAP BELT INSPECTION

- Periodically inspect belts, buckles, retractors, and anchors for damage that could lessen the effectiveness of the restraint system.
- Keep sharp edges and pointed objects away from belts.
- Replace belts if cut, weakened, frayed, or subjected to collision loads.
- Check that the anchor mounting bolts are tight.
- Have questionable parts replaced.
- Keep belts clean and dry.
- Clean only with mild soap solution and lukewarm water.
- Do not bleach or dye belts since this may severely weaken them.

CHILD RESTRAINT

Children in vehicles should be restrained to lessen the risk of injury in accidents, or sudden stops. In using any infant or child restraint system, read and follow all installation and usage instructions.

All unused lap belts near the child should be stowed properly to help prevent them from striking the child in the event of an accident. Lap belts without storage provisions should have buckles latched and belts adjusted to remove slack.

If a child is traveling in a vehicle not equipped with an appropriate infant or child restraint system, the following precautions should be taken:

1. Infants unable to sit up by themselves should be restrained by placing them in a covered, padded bassinet placed crossways in the vehicle (widthwise) on the **REAR-FACING** dinette seat. The bassinet should be securely restrained with the regular vehicle lap belts.

2. Children able to sit up by themselves should be placed on a seat and lap belted. Never allow a child to stand or kneel on any seat or elsewhere in the vehicle, once it is underway.

TRAILER HAULING

Towing a trailer will affect handling, durability and economy. Maximum safety and satisfaction depends upon proper use of correct equipment and avoiding overloads and other abusive operation.

The maximum loaded trailer weight which you can pull with your vehicle depends on what special equipment has been installed. GMC does not recommend towing any trailer **OVER 1,000 POUNDS GROSS TRAILER WEIGHT** unless the vehicle **HAS THE REQUIRED EQUIPMENT**. Information on trailer hauling capabilities, special equipment required, and optional equipment offered can be obtained by writing to GMC Truck & Coach Division, General Motors Corporation, Technical Service Department, Pontiac, Michigan 48053 (or in Canada, by writing to General Motors of Canada Limited, Owner Relations Department, Oshawa, Ontario L1J 5Z6).

To assist in attaining good handling of the Vehicle Trailer Combination, it is important that the trailer tongue load be maintained at approximately 10% of the loaded trailer weight. Tongue loads can be adjusted by proper distribution of the load in the trailer, and can be checked by weighing separately the loaded trailer and then the tongue.

When towing trailers, tires should be inflated to the highest inflation pressures shown on tire placard located on glove box door. The allowable passenger and cargo load (GVW) of this vehicle is reduced by an amount equal to the trailer tongue load on the trailer hitch.

MAINTENANCE

More frequent vehicle maintenance is required when being used to pull a trailer. Refer to "SERVICE and MAINTENANCE" section in this manual.

BREAK-IN SCHEDULE

In addition to the "New Vehicle Operating Speeds" given later in this section, it is recommended that your new vehicle be operated for 500 miles before trailer towing. If it is necessary to tow during this period, avoid speeds over 50 MPH, and full throttle starts.

CAUTIONS

1. Trailer brakes are required on trailers over 1,000 lbs. loaded weight.

2. **DO NOT** tap into vehicle's hydraulic brake system if operation of the trailer brake system requires more than 0.02 cu.-in. of fluid displacement from the vehicle's master cylinder. The vehicle's master cylinder fluid capacity will not be sufficient to operate both vehicle and trailer brakes under all conditions of use if more than 0.02 cu.-in. of fluid displacement is required.

3. Whenever a trailer hitch is removed, be certain to have any mounting holes in underbody properly sealed to prevent possible entry of exhaust fumes, dirt or water. (See "ENGINE EXHAUST GAS CAUTION" in the following section.)

OPERATION IN FOREIGN COUNTRIES

Your vehicle's engine is designed to operate on unleaded fuel of approximately 91 research octane number.

If you plan to operate your vehicle outside the continental limits of the United States or Canada, there is a possibility that the best fuels available are so low in anti-knock quality that excessive knocking and serious engine damage may result from their use. To obtain information on the quality of fuels available in the countries in which you plan to travel write to GMC Truck & Coach Division, General Motors Corporation, Pontiac, Michigan 48053 (or in Canada write to General Motors of Canada Limited, Owner Relations Department, Oshawa, Ontario), giving:

- The vehicle identification number (from plate attached to right side of dash panel or from the registration slip or title).
- The country or countries in which you plan to travel.

It is recommended that you do not operate your vehicle in any country not having fuels meeting the requirements of your vehicle's engine as these **MAY CAUSE ENGINE DAMAGE** for which GMC Truck & Coach is not responsible under the terms of the New Vehicle Warranty or Emission Control Systems Warranty.

TRIP TIPS

A small amount of preparation prior to a trip will save a lot of time when traveling.

When loading heavy items into your MotorHome try to store them as low and centrally as possible. This will aid performance and handling of the vehicle. Remember even though an item may not weigh much individually the sum weight of several of these articles may be substantial.

CAUTION

When transporting luggage or other cargo in your MotorHome, it is recommended that all articles be secured in place. This precaution will help prevent such items from becoming projectiles in the event of an accident.

The following emergency equipment is recommended, at minimum:

- Fire Extinguisher
- Hydraulic Jack and Lug Wrench
- Spare Tire
- Flashlight
- First Aid Kit
- Road Emergency Flares
- Basic Tool Kit

These items might be found useful:

- Plastic Bucket and Funnel
- Water Hose and "Y" Connection, in case of two units on one water system
- Level
- Shovel
- Spare Automotive Fuses and Bulbs
- 2" x 4" Chocks or Blocks

The following checks should be made before starting on a trip:

OUTSIDE VEHICLE

1. Run through "Driver Check List" at the beginning of this section.
2. Check engine oil level.
3. Check fluid levels on batteries.

4. Visually inspect radiator coolant level.
5. Fill windshield washer reservoir.
6. Check tire pressure, and inspect tires for road damage, foreign objects.
7. Check operation of all outside lights.
8. Check that all exterior vents are unobstructed.
9. Check and empty holding tank.

INSIDE VEHICLE

1. Check operation of optional Power Level System.
2. Check gasoline supply.
3. Check transmission fluid level.
4. Check power steering fluid level.
5. Check operation of windshield wipers and windshield washers.
6. Check operation of brakes.
7. Check operation of interior lights.
8. Check all appliances and fixtures for proper operation.
9. Check operation of motor generator.
10. Check and fill living area water system
11. Check and fill LP gas tank.
12. Check Maintenance Schedule folder to make sure all periodic maintenance and safety checks have been performed.
13. After the vehicle has been loaded, check to see that the vehicle's Gross Vehicle Weight, and front and rear axle capacities have not been exceeded. This check should be made fully loaded including passengers. (Refer to the "IMPORTANT INFORMATION ON VEHICLE LOADING" section of this manual for further information.)

Before leaving any camp-site make sure all litter has been picked up.

When traveling in winter it is recommended that the water tank not be filled until the destination is reached. This will ensure that the vehicle has thoroughly warmed up. The water and holding tank systems should be drained before leaving for home. Also, at this time, put some non-toxic, non-flammable anti-freeze into the sink and shower traps. Heat tape has been found useful in preventing pipe freeze-up, where power is available. Some non-toxic, non-flammable anti-freeze in the holding tank will help keep the tank contents from freezing. The recirculating toilet should be drained immediately at the end of the trip.

DRIVING TIPS

The MotorHome driver controls are automotive-type to make the vehicle as comfortable as possible. The steering and braking controls are power assisted to help make driving as effortless as possible. However, it must be remembered that the MotorHome is much higher, wider, and heavier than a family automobile.

Since the MotorHome is 9-ft. 2-in. high, with the roof mounted air conditioner, additional care is required to watch for low bridges and overpasses. **TREE BRANCHES CAN DO CONSIDERABLE DAMAGE TO THE WINDSHIELD OR ROOF OF THE VEHICLE TOO, SO WATCH FOR THEM.**

The MotorHome power-to-weight ratio is lower than that of the average automobile. Therefore it is essential to compensate for less acceleration when moving into traffic, or when passing another vehicle.

NEW VEHICLE OPERATING SPEEDS

Driving speeds for your new vehicle should be limited to a maximum of 50 MPH for the first 100 miles, and 65 MPH for the next 400 miles with no heavy throttle accelerations. If your initial mileage is of the around-town variety, which is considered "severe service" especially in cold weather, be sure to include some 25 to 50 mile highway trips during the break-in period and vary the vehicle's speed.

For continuing satisfaction keep your vehicle all GM. General Motors Parts are identified by one of these trademarks:



GMC MOTORHOME NOTES

STARTING AND OPERATING VEHICLE

ENGINE EXHAUST GAS CAUTION (CARBON MONOXIDE)

Avoid inhaling exhaust gases because they contain carbon monoxide which by itself is colorless and odorless. Carbon monoxide is a dangerous gas that can cause unconsciousness and is potentially lethal.

If, at any time, you suspect that exhaust fumes are entering the Motor-Home from any source have the cause determined and corrected as soon as possible. If you must drive before the cause is corrected, drive only with ALL except two rear windows FULLY open and heating or cooling system adjusted for maximum ventilation (see below).

The best protection against carbon monoxide entry into the vehicle body is a properly maintained engine exhaust system, body and body ventilation system. It is recommended that the exhaust system and body be inspected by a competent mechanic:

- Each time the vehicle is raised for lubrication or oil change.
- Whenever a change is noticed in the sound, alignment, or appearance of the exhaust system.
- Whenever the exhaust system, underbody or rear of the vehicle is damaged.

See your Maintenance Schedule folder for inspection procedure.

To allow proper operation of the vehicle's ventilation system, keep front inlet grille clear of snow, leaves, or other obstructions at all times.

OCCUPYING A PARKED VEHICLE WITH ENGINE RUNNING FOR AN EXTENDED PERIOD OF TIME IS NOT RECOMMENDED.

Do not run engine in confined areas such as garages any more than needed to move vehicle in or out of area. When vehicle is stopped in an UNCONFINED area with the engine running for any more than a short period of time, adjust heating or cooling system to force outside air into the vehicle as follows:

1. On vehicles not equipped with automotive air conditioning, set fan to medium or high speed and upper control lever to any position except "OFF." Lower control lever should be adjusted to any position except extreme left "RECIRC."
2. On vehicles equipped with automotive air conditioning, set fan to medium or high speed, upper control lever to any position except "OFF," and lower control lever to any position except extreme left "RECIRC."

The two rear windows should be closed while driving to avoid drawing dangerous exhaust gases into the vehicle through those openings. In addition, it is recommended that roof vent(s) be closed while driving. If, for some reason, a rear window or roof vent must remain open for a period while driving, or electrical wiring or other cable connections to a trailer must pass through the seal between them and the body, the following precautions should be observed.

- Close all windows.
- Adjust heating or cooling system to force outside air into the vehicle as described in Step 1 or 2 above but with fan set at high speed.
- Air vents in the instrument panel should be fully open.

It is important that the inside engine cover be properly seated to prevent possible leakage of exhaust fumes into the vehicle through this opening.

See "LIVING AREA FACILITIES CAUTION (CARBON MONOXIDE)" on page 29.

STEERING COLUMN CONTROLS

ANTI-THEFT STEERING COLUMN LOCK

The anti-theft ignition switch, located on the right side of the steering column, has five positions:

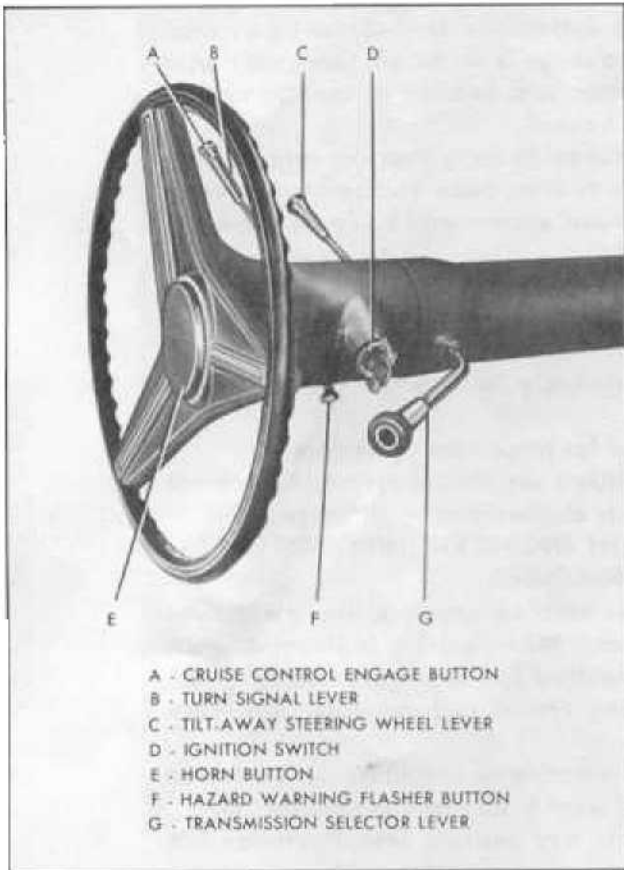

Steering Column Controls

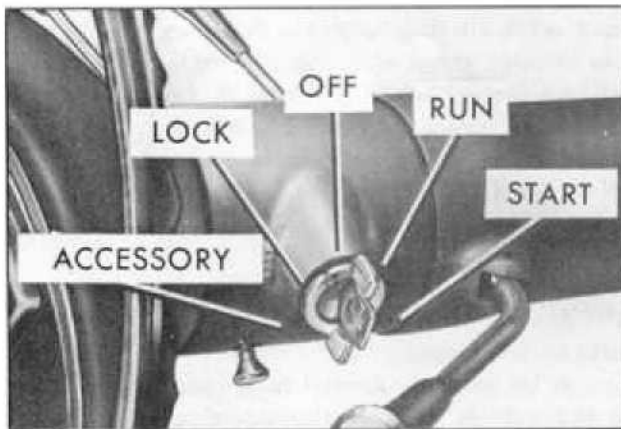

Anti-Theft Steering Column Lock

- **ACCESSORY**—Permits operation of electrical accessories when the engine is not running. To engage, push key in and turn toward you (counterclockwise).
- **LOCK**—Normal parking position, locks ignition and provides added theft protection by preventing normal operation of steering wheel and shift controls. Key cannot be turned to “LOCK” position and removed until transmission is placed in “PARK.”
- **OFF**—Permits turning engine off without locking steering wheel and shift controls.
- **RUN**—Normal operating position.
- **START**—Permits engagement of starter.

NOTE: The anti-theft steering column lock is not a substitute for the parking brake. Always set the parking brake when leaving the driver’s seat unattended.

If difficulty is experienced in turning the ignition key and lock knob to unlock the ignition, attempt to turn the steering wheel as hard as possible in the direction the wheels are turned. At the same time turn the ignition-lock knob in a clockwise direction with as much effort as you can apply with your own hand. Do not attempt to use a tool of any kind to apply additional force on the lock knob, as this could break the knob.

PARKING

When leaving the driver’s seat unattended:

- **SET PARKING BRAKE FIRST.** (See note on page 17.)
- Place transmission selector lever in “PARK.”
- Turn key to **LOCK** position.
- Remove key from steering column lock (the buzzer will remind you).
- Lock entrance door if leaving vehicle.

STARTING ENGINE

1. Apply the parking brake.
2. Place the transmission selector in “P” or “N” (“P” is preferred). A starter safety switch is designed to prevent starter operation while

the transmission selector is in any drive position. (If it is necessary to re-start the engine with the vehicle moving, place the selector lever in "N".)

3. Depress accelerator pedal and activate starter as outlined in the following, for different conditions.

COLD ENGINE

Fully depress accelerator pedal and slowly release. With foot off the pedal, crank the engine by turning the ignition key to the "START" position—release when engine starts. If engine starts but fails to run, repeat this procedure. When engine is running smoothly (approx. 30 seconds) the idle speed may be reduced by slightly depressing the accelerator pedal and then slowly releasing.

CAUTION

Extended running of the engine (5 minutes or more) without depressing the accelerator pedal, could cause damage to the engine or exhaust system due to overheating.

WARM ENGINE

Depress accelerator pedal about halfway and hold while cranking the engine.

EXTREMELY COLD WEATHER (BELOW 0° F.) OR AFTER VEHICLE HAS BEEN STANDING IDLE FOR SEVERAL DAYS

Fully depress and release accelerator pedal two or three times before cranking the engine. With foot off the accelerator pedal, crank the engine by turning the key to the start position—release key when engine starts.

IF ENGINE FAILS TO START:

- First, fully depress and release the accelerator pedal several times, then remove foot from accelerator pedal and crank engine.
- If engine still does not start, fully depress the accelerator pedal and hold to the floor while cranking the engine.
- If the engine has been flooded with gasoline, it may start to run but not have enough power to keep running. In this case, continue

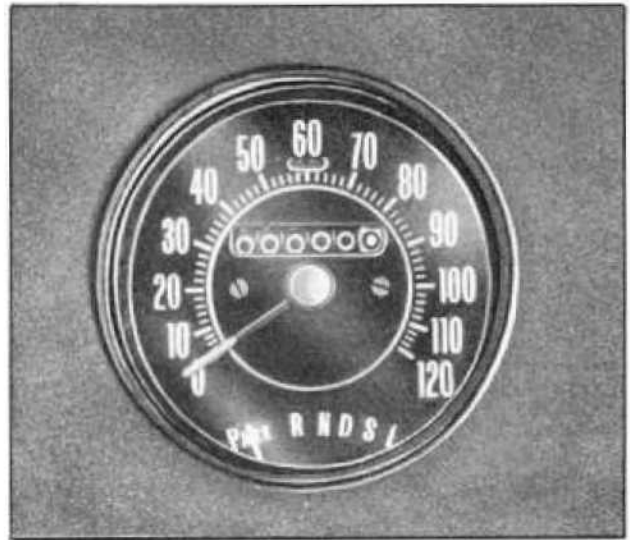

*Transmission Shift Indicator
and Speedometer*

cranking with the accelerator pedal fully depressed until the engine cleans itself of excess gasoline and runs smoothly.

- If engine doesn't crank properly due to a discharged main battery (automotive battery), place the battery switch in the "BAT BOOST" position. Switch is designed to return to the "BAT NORMAL" position after use.

NOTE: Do not continue cranking the engine for more than 30 seconds at a time to prevent starting overheating.

AUTOMATIC TRANSMISSION

The transmission selector lever is located on the right side of the steering column and the shift indicator is located in the bottom section of the speedometer cluster on the dash.

- "PARK"—Transmission lock when parking or while starting the engine. Pull the selector lever towards you to select or release this position. Never move the selector lever to "PARK" position unless the vehicle is completely stopped. "NEUTRAL" is the only other position in which your vehicle may be started.
- REVERSE "R"—For backing the vehicle. Bring the vehicle to a complete stop before moving the selector lever into Reverse.
- NEUTRAL "N"—The out-of-gear position. It is provided for starting a stalled engine

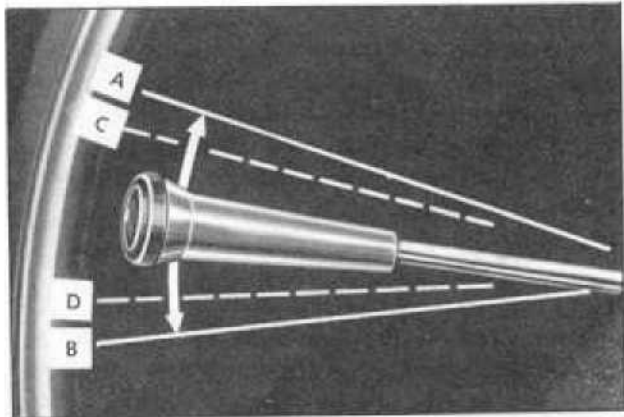

Turn Signal Lever

while the vehicle is in motion or running the engine while standing with brake applied. **DO NOT COAST IN NEUTRAL.**

- **DRIVE RANGE "D"**— The driving range for city and highway driving. This position permits the transmission to operate through its complete range of gear ratios and to select automatically the proper ratio for road and load conditions.
- **SUPER RANGE "S"**—Used when super performance is needed for increased acceleration in traffic, hill climbing, or "Engine Braking" down-hill. The selector lever may be moved from "D" to "S" and vice versa, under most operating conditions. "SUPER" should not be used at speeds above 75 MPH.
- **LOW "L"**—Available for heavy pulling through mud or sand and for engine braking when descending steep hills. The selector lever may be moved to "L" at any speed but the transmission will only shift automatically into Low range when the vehicle speed is under approximately 40 MPH. The transmission will not upshift from Low range as long as the selector lever is in the "L" position.

CAUTION

Before descending a steep or long grade, down a mountain or hillside, reduce speed and shift into a lower gear. Use the lower gear ranges to control vehicle speed. Avoid prolonged or frequent application of the brakes which could cause overheating and thus reduce brake effectiveness. Use caution

when shifting into lower range or lower gear on slippery surfaces with vehicle moving—abrupt engine braking action could cause the front wheels to skid, possibly leading to loss of vehicle control.

- **FORCED DOWNSHIFT** — When additional acceleration is desired to pass moving vehicles or to climb steep grades at speeds between approximately 35 and 65 MPH, the transmission can be downshifted by depressing the accelerator pedal completely to the floor. It is also possible to obtain a forced downshift in "DRIVE" range at speeds under 35 MPH by depressing the accelerator pedal part way down.

TURN SIGNAL AND LANE CHANGE FEATURE

Whenever a right or left turn is intended, when changing lanes, or when pulling away from the curb, use the turn signals.

- **FULL TURN** — For normal turns, move the turn signal lever to position "A" for right turn and "B" for left turn. Lever will remain in position without manual effort until the turn is completed, then cancel automatically.
- **LANE CHANGE** — Move lever to the detent position "C" for change to right lane or to "D" for change to left lane. Hold lever in position until lane maneuver is completed, then release. Lever will return to "OFF" position.

HAZARD WARNING FLASHER

For operation of hazard warning flasher, see "In Case of Emergency" later in this manual.

HORN CONTROL

The horn is actuated by depressing the circular shaped button located in the center of the steering wheel.

POWER STEERING

If the steering system power assist fails due to some malfunction, or because the engine has stalled, the vehicle can still be steered. However, much greater effort is required, particularly in sharp turns.

TILT STEERING WHEEL

The tilt steering wheel can be tilted up above normal position to provide additional room for entrance and exit as well as selected driving positions above or below normal height.

The tilt mechanism is operated by lifting up on the small control lever, on the left side of the steering column just below the directional signal lever, then moving the steering wheel to the selected position and releasing the lever.

CRUISE CONTROL

The optional Cruise Control is an automatic speed control system which is designed to allow the vehicle to hold a selected speed of approximately 30 MPH or higher—depending on engine limitations—thus increasing comfort and economy on turnpikes, and other non-congested highways.

- **TO OPERATE** – The Cruise Control engagement button is located in the end of the turn signal lever. Accelerate the vehicle to the desired speed and momentarily push in the engagement button, take your foot off the accelerator and this speed will be maintained.
- **TO RESET AT A FASTER SPEED** – Accelerate the vehicle to the desired higher speed, push in the engagement button fully and release slowly.
- **TO RESET AT A SLOWER SPEED** – Depress the engagement button fully and **HOLD**. Allow vehicle to decelerate. When vehicle reaches desired speed, release the engagement button slowly.
- **FOR PASSING** – You can increase your speed by depressing the accelerator pedal. When you remove your foot from the pedal, the vehicle will slow down to the cruising speed set prior to the acceleration.
- **TO DISENGAGE** – Lightly apply the brake pedal to disengage system.

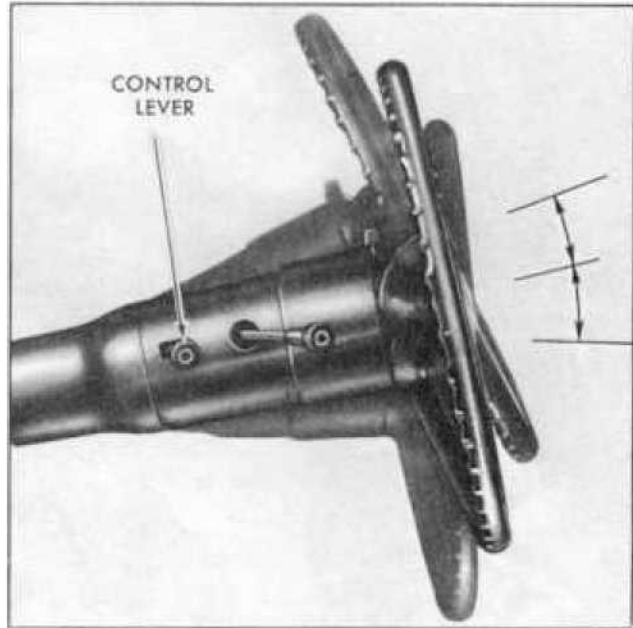

Tilt Steering Wheel

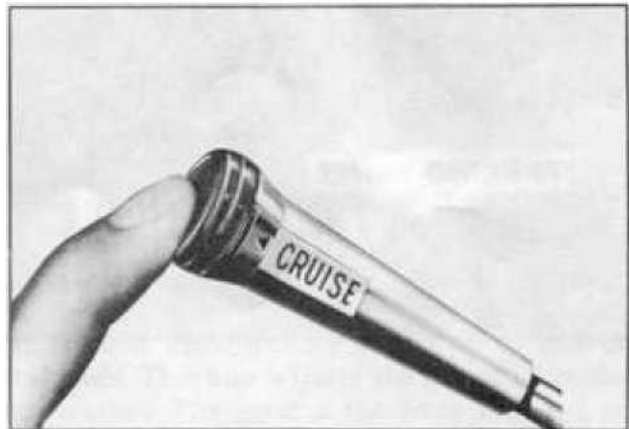

Cruise Control Lever

CAUTION

DO NOT use the Cruise Control when conditions are not suitable for maintaining a constant speed, such as in heavy or varying traffic, or on winding or slippery roads. With the Cruise Control engaged, removing foot from the accelerator pedal does not permit engine speed to return to idle.

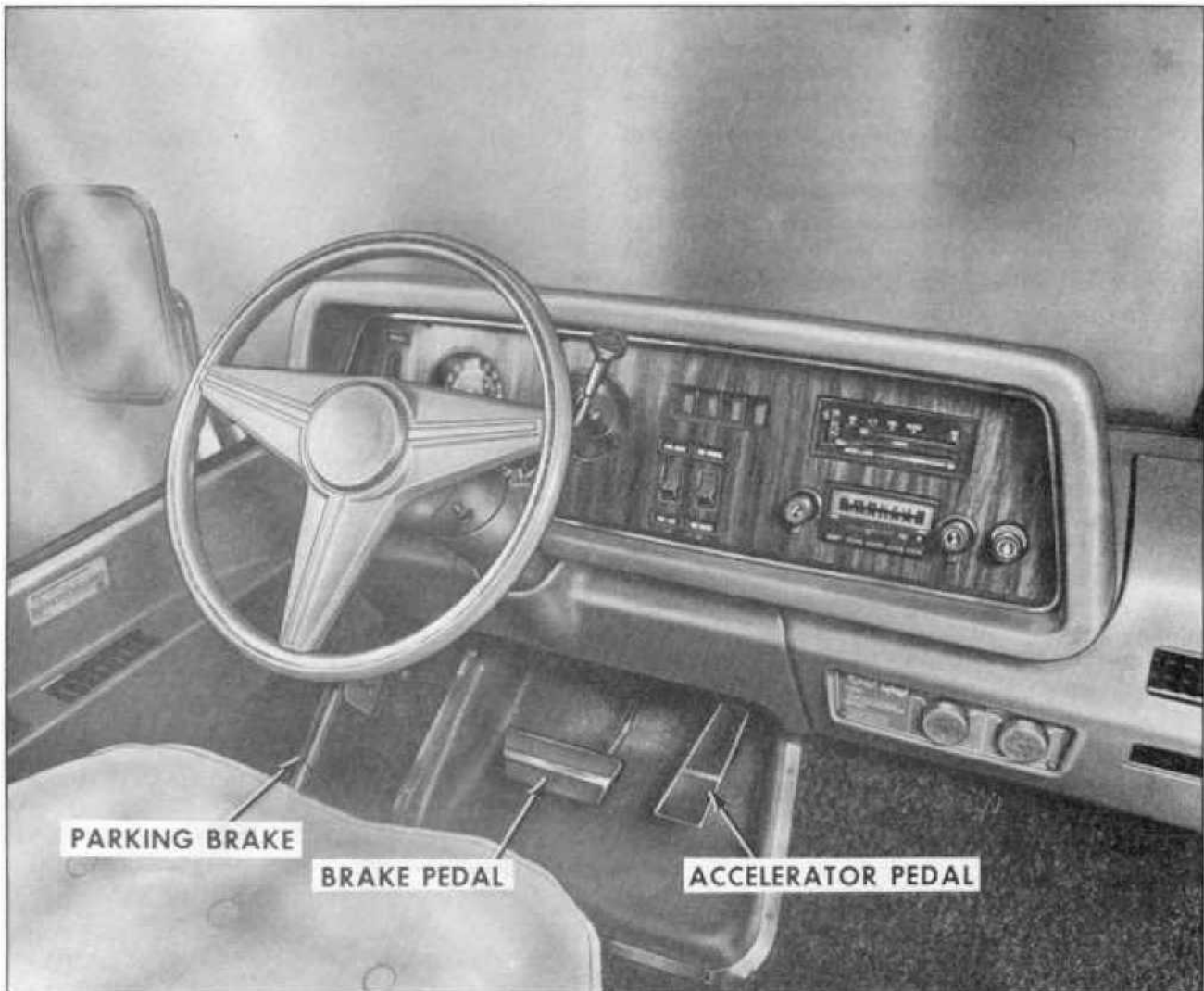

Vehicle Floor Controls

FLOOR CONTROLS

POWER BRAKE SYSTEM

This vehicle is equipped with a Dual Hydraulic Split System With Power Assist. It is also equipped with disc type brakes on the front wheels and drum type brakes on the tandem rear wheels.

NOTE: Operation of the brake system warning light is covered (on page 19) (in the section on "Instrument Panel and Controls").

CAUTION

Driving through deep water may wet the brakes and adversely affect brake performance so that the vehicle will not slow down at the usual rate, and may

pull to the right or left. Applying the brakes lightly will indicate whether they have been so affected. To dry them quickly, lightly apply the brakes while maintaining a safe forward speed with an assured clear distance ahead until brake performance returns to normal.

- On your vehicle, if power assist to the brakes is interrupted due to a stalled engine or some malfunction, two or more brake applications can normally be made using reserve power.
- If the brake pedal is held down, the system is designed to bring the vehicle to a full stop on reserve power. However, the reserve power

SELF-ADJUSTING BRAKES

Brakes on this vehicle (except for the Parking Brake) are self-adjusting, designed to eliminate periodic adjustments.

Drum brake adjustments are made automatically as the brakes are applied while vehicle is moving backwards.

Disc brake adjustment is made automatically with each brake application.

- If excess brake pedal travel develops, drive alternately backward and forward several times and apply brakes firmly in each direction.
- See your dealer if normal pedal travel is not restored, or if there is a rapid increase in pedal travel, which could be a sign of other brake trouble.

NOTE: "Riding The Brake" by resting your foot on the brake pedal when not intending to brake can cause abnormally high brake temperatures, excessive lining wear and possible damage to brakes.

REMINDER: Front disc brakes have a built-in wear indicator that is designed to make a high frequency, squealing, or cricket-like warning sound when the linings are worn to where replacement is required. The sound will occur intermittently or continuously when wheels are rolling, but will disappear when the brake pedal is applied firmly. See also the various brake checks listed in the maintenance schedule folder.

PARKING BRAKE

- To set parking brake, pull up the handle located on the floor against the left wall, below the instrument panel.
- For maximum holding power, depress regular brake pedal with the right foot at the same time.
- To release parking brake push the handle down.

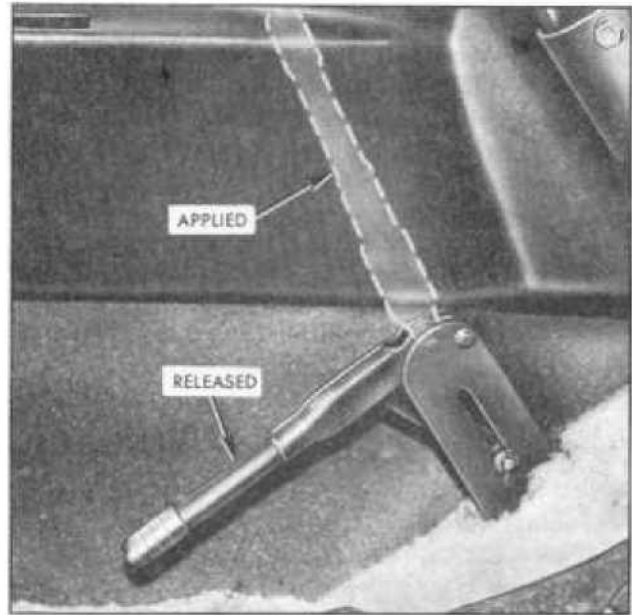

Parking Brake Control

the level. If "torque lock", as this condition is called, does occur, it may be necessary to have another vehicle nudge this vehicle up hill, to take some of the pressure off the transmission while the driver pulls on the transmission selector lever.

HEADLIGHT DIMMER SWITCH

To obtain high or low beam headlights, push the foot dimmer switch located on the floor to the left of the brake pedal. Each time the switch is depressed, the light beam changes. A headlamp

beam indicator, on the face of the speedometer, is designed to light up when the headlights are on high beam.

HEADLIGHT "FLICKER"

The headlight circuits are protected by a circuit breaker in the light switch. An overload on the breaker will cause the lights to "flicker" on and off, or in some cases to remain off. If this condition develops, have your headlight electrical circuit checked immediately.

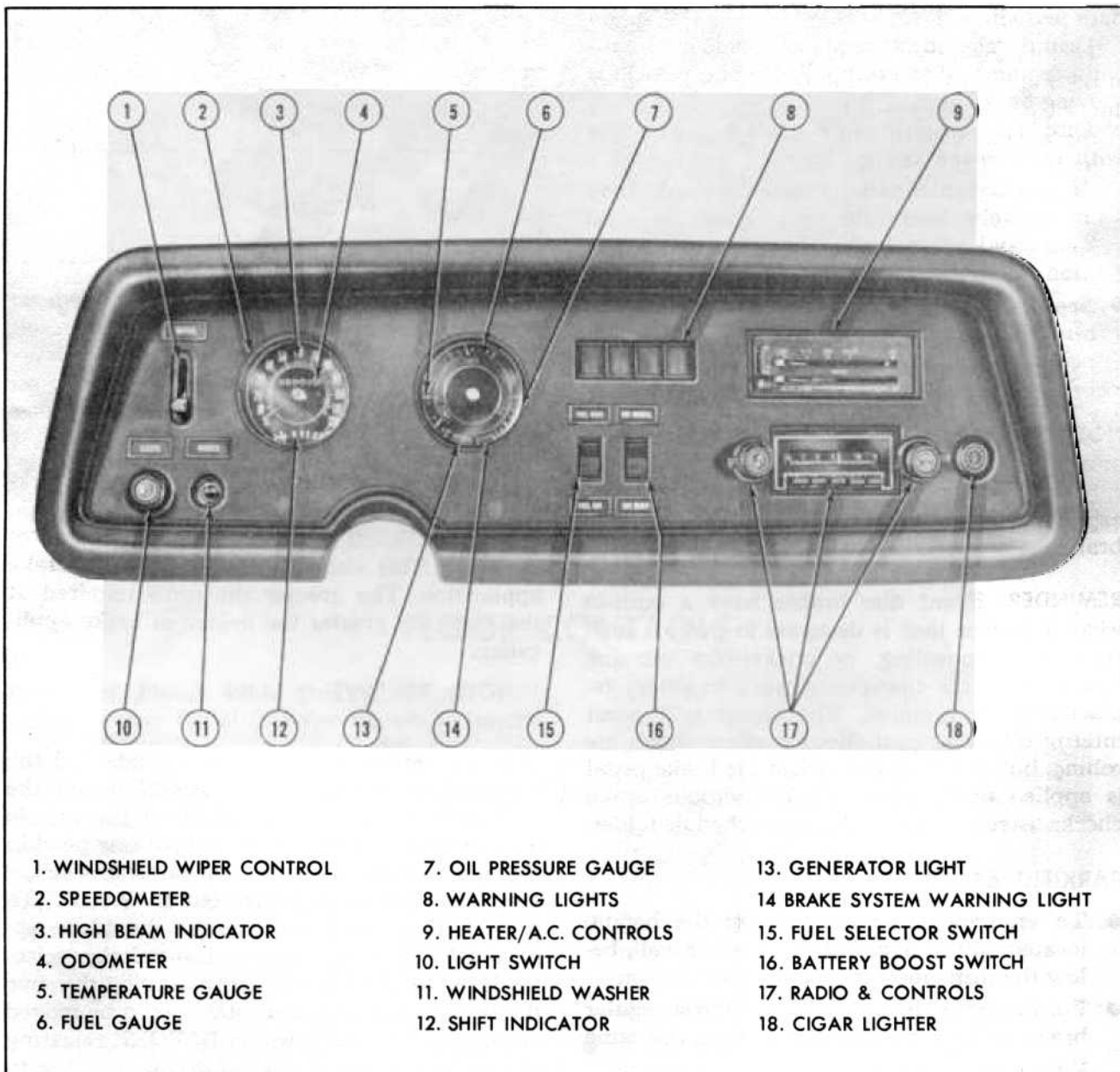

Instrument Panel

INSTRUMENT PANEL AND CONTROLS

SPEEDOMETER AND ODOMETER

The speedometer indicates the forward speed of the vehicle in miles-per-hour. The odometer registers the accumulated mileage the vehicle has been driven. Also, located in the speedometer cluster are the turn signal indicators which show direction and proper operation of the turn signals, the high beam indicator light, and the shift indicator.

FUEL GAUGE

This gauge shows the approximate fuel level in the main tank when fuel selector switch is in the "FUEL MAIN" position, and the fuel level in the auxiliary tank when fuel selector switch is in the "FUEL AUX" position. The pointer will indicate the correct positions only when the ignition is in the "ON" position.

Since both fuel tanks are interconnected, the indicated level is designed to read the same (with the switch in either position) until approximately 60% of the total fuel capacity has been used. See "Fuel Selector Switch" later in this section.

TEMPERATURE GAUGE

This gauge registers the temperature of the engine coolant. The center area of the water temperature gauge marks the normal operating range. However, if the needle moves beyond the center area marks into the "H" side or hot area of the gauge, stop the engine as soon as possible, and remain stopped until the cause of the overheating is determined.

OIL PRESSURE GAUGE

This gauge registers engine oil pressure. The consistency of the oil in a cool engine will cause a high reading when the engine is first started. As the engine warms, the pressure will recede to normal. With the engine warmed up to normal operating temperature, minimum pressure at idle should be slightly above the "L" graduation (8 PSI). At normal operating speeds, minimum pressure should be between the second and middle graduations (35 PSI). Should the pressure drop below these minimums, stop the engine immediately and check the cause of the low

oil pressure. This could be the result of a dangerously low oil level in the crankcase. Driving the vehicle with low oil pressure can cause extensive engine damage.

CHARGING SYSTEM WARNING LIGHT

Located to the right of the temperature gauge is the charging system warning light. A red light "GEN" will appear with the ignition key in the "ON" position and the engine not running. This light lets you know the warning signal is operational. Should the light fail to come on, see your MotorHome dealer. When the engine is started, the warning light should go out and remain out. If the light remains on when engine is running, have your dealer locate and correct the trouble as soon as possible.

BRAKE SYSTEM WARNING LIGHT

The service brake system is designed so that half of the brake system will provide some braking action in the event of a hydraulic leak in the other half of the system. If the red warning light, located to the left of the oil pressure gauge, glows continuously when the engine is running and after the brakes have been firmly applied, it may indicate that there is a malfunction in one part of the brake system.

- As a check on bulb condition the light should glow during engine starting.
- Have system repaired if light does not come on during check.
- This warning light is not a substitute for the visual check of brake fluid level required as part of normal maintenance.



Speedometer and Gauge Clusters

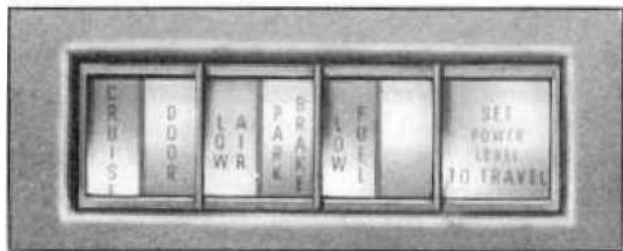

Warning Light Cluster

WHAT TO DO IF LIGHT GLOWS RED:

- The service brake system is partially inoperative.

1. Pull off the road and stop, carefully—remembering that:

- Stopping distances may be greater.
- Greater pedal effort may be required.
- Pedal travel may be greater.

2. Try out brake operation by starting and stopping on shoulder of road — then:

- If you judge such operation to be safe, proceed cautiously at a safe speed to nearest service outlet for repair, or
- Have vehicle towed to dealer for repair.

Continued operation of the vehicle in this condition is dangerous.



Windshield Wiper, Washer, and Headlight Controls

TELL-TALE WARNING LIGHT CLUSTER

A cluster of indicator lights is located just to the left of the heater controls. These are designed to inform the driver of the status of certain systems or conditions of which he should be aware. Among these are:

- “CRUISE” (Optional Equipment) — This indicator is designed to glow GREEN whenever the Cruise Control System is engaged and working.
- “DOOR”—The door light is designed to warn the driver that the entrance door is not properly closed.
- LOW AIR—The low air light is designed to warn the driver that air pressure in the rear suspension system is abnormally low. (See “Emergency Operation,” page 26, later in this section.)
- “PARK BRAKE”—As a reminder, the “PARK BRAKE” brake reminder light is designed to glow whenever the parking brake control is not fully released and the ignition is on.
- “LOW FUEL” (Optional Light) — The low fuel warning light in your vehicle is designed to come on when the main tank has less than five gallons of fuel left and the fuel selector switch is in the “FUEL MAIN” position. If, at any point after this, the fuel selector switch is changed to “FUEL AUX” the “LOW FUEL” warning light will then go out and come on again when the fuel in the auxiliary tank goes below five gallons. At this point both fuel tanks of your vehicle are nearly depleted.
- “SET POWER LEVEL TO TRAVEL” (Optional Light)—This light is designed to inform the driver that the optional power level controls should be set to the “TRAVEL” position before driving the vehicle (also a buzzer will sound for approximately 10 seconds). This will allow your vehicle’s air suspension system to automatically maintain the proper suspension pressure while the vehicle is being driven. (See “Power Level System” later in this section.)

HEADLIGHT SWITCH

The headlight switch serves four functions:

1. Pulling the switch half-way out provides parking lights, instrument panel lights, tail lights, side marker lights, and clearance and identification lights.
2. Pulling the switch all the way out provides all driving lights, — this includes headlights, plus those mentioned above.
3. To dim instrument panel lights, turn switch knob clockwise.
4. To operate the dome lights, turn switch knob fully counterclockwise.

WINDSHIELD WIPER LEVER

The windshield wipers are variable speed, and hydraulically powered. The lever control, on the left side of the instrument panel varies the speed of the wiper blades from stop (“DOWN” position) to fast (extreme “UP” position).

WINDSHIELD WASHERS

The windshield washers are controlled by the washer switch located under the windshield wiper lever. To operate the washers, turn the wipers to an ON position, then push down on the switch until the desired amount of washer fluid has been directed to the windshield.

- Check washer fluid level regularly — do it frequently when the weather is bad.
- Use a fluid such as GM OPTIKLEEN to prevent freezing damage, and to provide better cleaning.
- Do not use radiator anti-freeze in windshield washer; it could cause paint damage.
- In cold weather, warm the windshield with defrosters before using washer — to help prevent icing that may seriously obscure vision.

FUEL SELECTOR SWITCH

The fuel selector switch, located below the warning light cluster, has two positions—“FUEL MAIN” and “FUEL AUX.” This switch allows the driver to change the fuel pick-up and fuel gauge sending unit from the main tank, as it

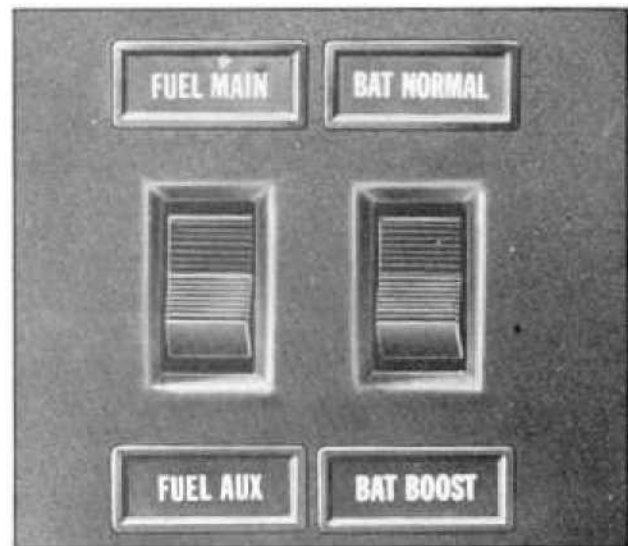

Fuel Tank and Battery Switches

goes empty, to the auxiliary tank which will normally contain 7 to 9 gallons of fuel. It is recommended that any time the fuel system is filled, this switch be put in the “FUEL MAIN” position and left there until auxiliary fuel is needed.

BATTERY BOOST SWITCH

The GMC Dual Battery System provides power from two batteries to the vehicle’s 12-volt electrical system either in combination or singularly. The components used to provide charging and/or switching are conventional, except for a diode assembly with which both batteries will receive charging current whenever the vehicle is running. The diode assembly has separate outputs to the two batteries and provides isolation between the batteries and their associated circuits whenever the engine is not running.

The main battery (or automotive battery) supplies power to the chassis circuit; i.e., engine, external lights, etc. The auxiliary battery (living area battery) powers the MotorHome living area; i.e., internal lights, refrigerator, etc.

When additional power is needed for either battery circuit, hold switch momentarily in “BAT BOOST” position. After use, switch is designed to return to the “BAT NORMAL” position.

NOTE: If the battery boost switch is retained in the “BAT BOOST” position for extended periods this can result in both batteries being discharged.

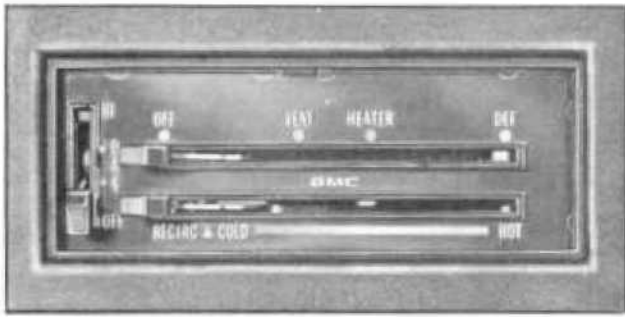

*Automotive Heating System Controls
(with Type 1 Fan Switch)*

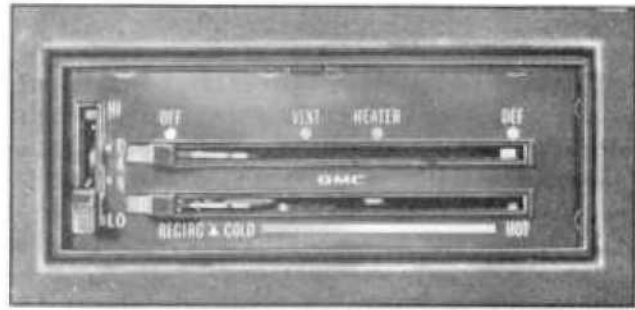

*Automotive Heating System Controls
(with Type 2 Fan Switch)*

The auxiliary (living area) battery will recharge itself whenever the motor generator is running, or whenever your MotorHome is connected to an external power source (see page 30), in addition to being recharged while the vehicle's engine is running.

CIGAR-CIGARETTE LIGHTER

Push the lighter in all the way to operate. When it is heated sufficiently to use, it is designed to "snap" back to normal position with noticeable sound. Avoid holding the lighter in by hand while it is heating.

For added safety, the cigar-cigarette lighter has a heat-sensitive terminal which is designed to melt and break the circuit if the lighter becomes overheated.

HEATING SYSTEM (WITHOUT AUTOMOTIVE AIR CONDITIONER)

The heating system controls are located on the instrument panel to the right of the steering column. There are three separate controls; "FAN" lever to control speed of blower operation; "RECIRC," "COLD," "HOT" lever to control temperature of air; "OFF," "VENT," "HEATER," "DEF" lever to control direction of air flow. The "FAN" lever works vertically and the other two levers work horizontally. The three levers may be placed in any combined position to deliver the climate conditions most desirable at any given time.

- **TYPE 1 "FAN"**—The fan switch has four positions; "OFF" and three blower speeds ranging to "HI" and two unmarked positions between "OFF" and "HI." The fan will not operate unless the top lever has been moved from the "OFF" position, and in order

to operate the fan in the "HI" position the engine must be running.

- **TYPE 2 "FAN"**—The fan switch has four positions; "LO" and three blower speeds ranging to "HI." Fan will operate whenever the key is in the "RUN" or "ACCESSORY" position. In order to operate the fan in the "HI" position the engine must be running.
- **"OFF," "VENT," "HEATER," "DEF"**—With the lever in the "OFF" position the system is off. With the lever in the "VENT" position 100% outside air enters the driver's compartment. The air enters through the dash mounted outlets and through the heater outlets. Temperature of incoming air may be controlled by moving the "RECIRC," "COLD," "HOT" (temperature) lever to desired position. Any one of the blower speeds may be selected.

With the lever in the "HEATER" position, air will flow through the heater floor distributor outlet (with slight flow of air to the defroster outlet). For maximum heat, move temperature lever to "HOT" position and "FAN" switch lever to "HI" position. Heating system output can be varied by moving temperature lever and "FAN" lever to different positions.

With the lever in the "DEF" position, the system operates the same as in the "HEATER" position except most of the air flow will be through the defroster outlets at the windshield.

- **"RECIRC," "COLD," "HOT"**—This lever, used in conjunction with the system selector lever ("OFF," "VENT," "HEATER," "DEF") and the "FAN" switch lever, will control the temperature of the output air being distributed.

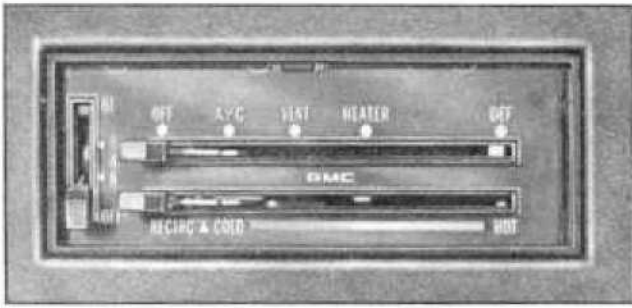

*Automotive Air Conditioner Controls
(with Type 1 Fan Switch)*

- Clear windshield, rear window, outside mirror, and all side windows of ice and snow before driving vehicle.
- Operate blower on "HI" for a few seconds before moving the vehicle, to clear the air intake of snow.

AUTOMOTIVE AIR CONDITIONER

The Automotive Air Conditioning System offers year-round driving comfort. In addition to providing circulation of cool air during hot weather, the system can provide warm air in cold weather and dehumidify outside air in humid weather.

Combined air conditioning and heating system controls are located on the instrument panel in the upper right-hand corner. There are three separate controls; "FAN" lever, to control speed of blower; "OFF," "A/C," "VENT," "HEATER," "DEF" lever to control direction of air flow and which system is to be operated; "RECIRC," "COLD," "HOT" lever to control the temperature of the air. The three levers may be placed in many combined positions to deliver the climate conditions most desirable at any given time.

- **TYPE 1 "FAN"**—The fan switch has four positions; "OFF" and three blower speeds ranging from "LO" to "HI." The fan will not operate unless the top lever has been moved from the "OFF" position, and in order to operate the fan in the "HI" position the engine must be running.
- **TYPE 2 "FAN"**—The fan switch has four positions; "LO" and three blower speeds ranging to "HI." Fan will operate whenever

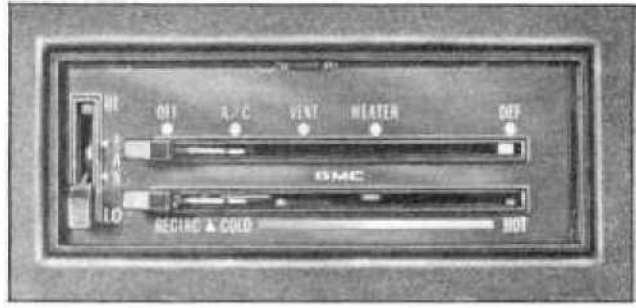

*Automotive Air Conditioner Controls
(with Type 2 Fan Switch)*

- the key is in the "RUN" or "ACCESSORY" position. In order to operate the fan in the "HI" position the engine must be running.
- **"OFF," "A/C," "VENT," "HEATER," "DEF"**—With the lever in the "OFF" position the system is off. With the lever in the "A/C" position (and the "RECIRC," "COLD," "HOT" lever at "RECIRC" position) the air conditioning system is activated and the blower automatically goes to "HI" speed providing the engine is running. This position uses 80% recirculated air. This setting will provide maximum cooling. In combination with "A/C" setting moving the temperature lever to the "COLD" position provides 100% outside air. Further movement of the temperature lever to the right (toward "HOT" position) will heat the dehumidified air to the desired temperature. The "FAN" switch can be set to meet air flow requirements.

With the lever in the "VENT" position, 100% outside air enters the driver's compartment. This setting is for use during periods of less severe heat and humidity, air flow is identical to air flow in "A/C" position, however, the air conditioning compressor is not operating. Temperature of incoming air may be controlled by moving the temperature lever to the desired position. Any one of the blower speeds may be selected.

With the lever in the "HEATER" position, air will flow through the heater floor distributor outlets (with a slight flow of air to the defroster outlet). For maximum heat, move the temperature lever to "HOT" position and "FAN" switch lever to "HI" position.

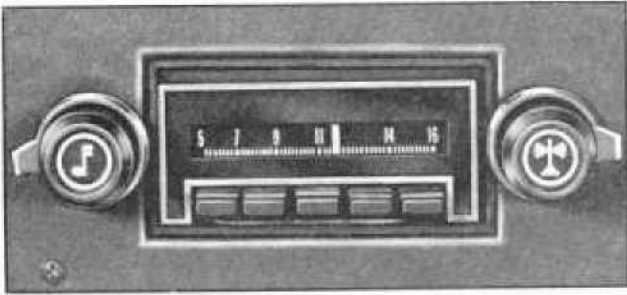

Push Button AM Radio

Heating system output can be varied by moving temperature lever and "FAN" lever to different positions.

With the lever in "DEF" position, system operates the same as in the "HEATER" position except most of the air flow will be through the defroster outlets at the windshield.

- "RECIRC," "COLD," "HOT" – This lever, used in conjunction with the system selector lever ("OFF," "A/C," "VENT," "HEATER," "DEF") and the "FAN" switch lever, will control the temperature of the output air being distributed.

CAUTION

Operate in "DEF" position for 30 seconds before switching to "A/C." This will remove humid air from the system and minimize rapid fogging of the glass which can occur if humid air is blown onto a cool windshield.

- Clear windshield, rear window, outside mirrors, and all side windows of ice and snow before driving vehicle.
- Operate blower on "HI" for a few seconds before moving the vehicle, to clear the air intake of snow.

RADIOS AND TAPE DECK

PUSH BUTTON "AM" RADIO

The "ON-OFF" switch is on the left-hand center knob with the volume control. The left-hand outside knob varies the tone response of the receiver. The right-hand center knob is used to select the station desired. The right-hand outside knob adjusts the volume of front and rear speakers.

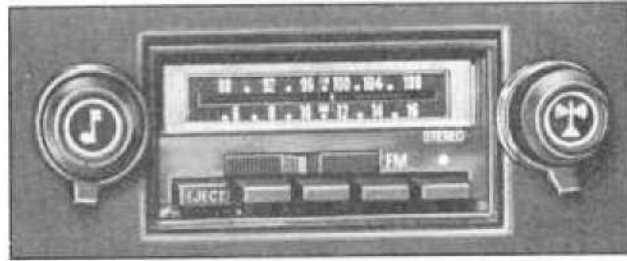

AM-FM Stereo Radio with Tape Deck (Tape Removed)

In addition to the manual controls, this radio provides five push buttons with which to automatically select pre-set stations. To pre-set, pull the push button "out" as far as it will go, tune in the desired station manually, and then push the button "in."

Repeat this operation for each push button.

AM-FM RADIO

In addition to providing standard AM reception, this set permits you to receive clear static-free FM broadcasts. Move the slide bar, above the push buttons to the right or left to select AM or FM reception. All other controls remain the same as described for push button radios. FM broadcasts may be received as far as 25 miles from the sending station, depending on the power of the station and the existing terrain. In fringe areas, it may be possible to retune the radio slightly to maintain peak reception. If not, retune to a closer or stronger FM station or switch to AM operation. Push buttons may be set for both AM or FM stations as follows:

- Place slide bar in AM position.
- Pull push button out as far as it will go, tune in desired AM station manually and then push button in to LOCK-IN position.
- Repeat for each remaining push button.
- Place slide bar in FM position and repeat procedures outlined for AM band setting.

IMPORTANT: Bands should not be changed if push button is unlocked or radio may be damaged.

ANTENNA

The radio antenna is mounted on top of the vehicle. If necessary, adjustments for maximum antenna effectiveness on AM can be made by your authorized GMC MotorHome dealer.

STEREO RADIO

Stereo Receivers permit FM stereo reception with the AM-FM radio. Radio controls are used to turn the set on and off and for station selection. For most pleasing stereo effect, the speakers are criss-crossed, with the left front and right rear speakers reproducing the left channel, and the opposite speakers reproducing the right channel. Balancing the speakers is not required as this adjustment has been made at the factory. Should it become necessary to make this adjustment, see your GMC MotorHome dealer. The indicator light will be on when the radio is tuned to an FM stereo station. Most broadcasts on such stations will be in stereo.

To Tune Your Stereo Radio

- Tune radio to an FM Stereo station (one which makes the indicator light come on with a steady glow).
- Tune the lever behind the station selector knob until volume from front and rear speakers sounds equal.
- Regulate volume and tone controls as required.

STEREO TAPE SYSTEM

The optional Stereo Tape Player provides prerecorded stereo programs for your enjoyment.

To play, insert cartridge through tape door with label side up and open end in first. Tape will play through all four programs in succession, then replay in same sequence. Balancing the speakers is not required as this adjustment has been made at the factory. Should it become necessary to make this adjustment, see your GMC MotorHome dealer.

1. Rotate fader control until volume from front and rear speakers sounds equal.
2. Regulate volume control and tone controls as desired.
3. To change program track, push in volume control knob and release; player will index to next track.
4. Push in the "eject" button to remove tape cartridge from player.

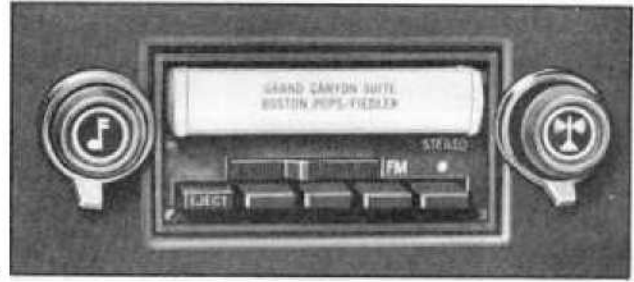

AM-FM Stereo Radio with Tape Deck (Tape Installed)

Cleaning and Care

Every 100 hours of operation, or if tape slips and runs slowly, the capstan (revolving metal post), head and tape guide should be cleaned with a cotton-tipped swab moistened with alcohol (do not use carbon tetrachloride). To clean the capstan, trip the "ON-OFF" switch at the rear of the receptacle with your finger and hold the swab against the rotating capstan.

IMPORTANT: When tape player is not in use, remove the cartridge and store it in a cool, dry place out of direct sunlight. If the cartridge is not removed, the radio may be inoperative and possible roller damage to the tape unit could occur.

MOBILE RADIO TRANSMITTERS

Mobile radio transmitting equipment is subject to Federal Communications Commission regulations and must be installed by a qualified radio technician. The specific installation instructions for radio transmitters will vary depending upon the radio equipment used. Mobile telephone equipment installed by your local telephone company, citizens band radios and electronic garage door openers will not adversely affect vehicle operation. In the event any other type of mobile radio transmitter is to be installed, further instructions are required so that vehicle operation will not be adversely affected. Contact GMC Truck & Coach Division, General Motors Corporation, Technical Service Department, Pontiac, Michigan 48053 (or in Canada, contact General Motors of Canada Limited, Product Service Department, Oshawa, Ontario).



Power Level System Controls

POWER LEVEL SYSTEM

The optional Power Level System provides the ability to level the vehicle at campsite or parking area where the ground is not level. This system overrides the automatic leveling feature that maintains a constant ride height at the rear tandem suspension. The Power Level System can raise or lower the rear of the vehicle approximately 4 inches from normal ride height.

The Power Level Controls are located to the right of the steering wheel at the lower portion of the dash panel.

NORMAL OPERATION

The controls consist of two knobs labeled: "LEFT REAR" and "RIGHT REAR." Each knob has four positions and is used as follows: "RAISE"—Knob in this position will raise rear of vehicle to any desired level, up to a maximum of 4 inches above normal ride height. When desired height is reached, turn indicator on knob to "HOLD" position.

"HOLD"—When indicator line on knob is turned to this position the appropriate side of the vehicle will remain at that height. This can be done after being either in the "RAISE" or "LOWER" position. It is recommended that when vehicle is parked that the two knobs be turned to "HOLD."

"LOWER"—With the indicator line in this position the appropriate side of the vehicle will lower a maximum of 4 inches below normal ride height. In order to maintain a desired height turn indicator on knob to "HOLD."

"TRAVEL"—Whenever driving vehicle on highways or improved roads place indicator line in "TRAVEL" position. This will automatically maintain a constant ride height at the rear (approx. 8-inch ground clearance at rear). A reminder light in the dash panel is designed to light any time the engine is running and the transmission selector lever is moved to "D" (Drive Range).

When using Power Level the vehicle engine need not be running to operate the system, however, the ignition key must be in the "ACCESSORY" position.

A glass of water or a bubble type level when placed in a normally level location inside the vehicle can be used to assist in determining the desired level condition.

OFF-ROAD OPERATION

In order to gain maximum ground clearance both control knobs should be placed in the "RAISE" position. It is recommended that a speed of 15 MPH should not be exceeded since the air suspension in this position has maximum pressure supplied.

EMERGENCY OPERATION

In the event of total air loss ("LOW AIR" warning light illuminated) for any reason, the vehicle may be driven at a speed of 5-15 MPH (depending on road surface) with the rear of the vehicle in the fully "DOWN" position. Care should be exercised since ground clearance at the rear will be at a minimum. Vehicle should be taken to nearest dealer.

Depending on the type of failure, it may be possible to add air to the rear suspension air reservoir (shop air fill valve located on reservoir) by filling reservoir at a local gas station (DO NOT EXCEED 120 PSI).

MAINTENANCE

No routine maintenance is required on the Power Level System. Refer to **SERVICE AND MAINTENANCE** section later in this manual for "Rear Suspension" Maintenance.

For continuing satisfaction keep your vehicle all GM. General Motors Parts are identified by one of these trademarks:



GMC MOTORHOME NOTES

OPERATION OF LIVING AREA FACILITIES

LIVING AREA FACILITIES CAUTION (CARBON MONOXIDE)

Carbon monoxide is a colorless and odorless gas and can cause unconsciousness and is potentially lethal in high concentrations.

Whenever operating the optional motor-generator it is essential the left-rear window of the vehicle be kept closed to prevent possible entry of motor-generator exhaust gases into vehicle. Inspect the motor-generator exhaust system at vehicle lubrication intervals or when a change is noticed in the sound, alignment, or appearance of the exhaust system or if it is damaged. Do not run motor-generator in a confined area, such as a garage.

The MotorHome is equipped with LP gas operated range/oven, furnace, and may be equipped with an optional gas/electric refrigerator. These components generate carbon monoxide when operated and should be used only if there is adequate ventilation. Whenever operating range or oven(s) be sure power range hood, furnace, and gas/electric refrigerator are open and kept clean and free from clogging materials such as snow, leaves, dirt, grease, etc.

See ENGINE EXHAUST CAUTION (carbon monoxide) page 11.

LIVING AREA ELECTRICAL SYSTEM

GENERAL INFORMATION

The MotorHome living area electrical system is designed for utmost convenience. It is capable of supplying the vehicle with power from at least two sources (three, if equipped with a motor generator).

All electrical components except the water heater, the roof mounted air conditioner (if equipped), and the plug receptacles, are powered by the 12-volt auxiliary (living area) battery which is automatically charged each time the vehicle's engine is running.

In addition, your vehicle may be plugged into a 120-volt external power source which will supply 120-volt power throughout the living area, power all 12-volt components through a power converter, and charge the living area battery.

If your MotorHome is equipped with a motor generator, the vehicle will be supplied with 120-volt and 12-volt power throughout the living area, and recharge the living area battery, any time the motor generator is running.

120-VOLT TO 12-VOLT CONVERTER AND BATTERY CHARGER

The MotorHome is equipped with a 45 amp 120-volt to 12-volt power converter. Its function is to take a portion of the 120-volt current, that is received when the vehicle is plugged into an external power source, or when the motor

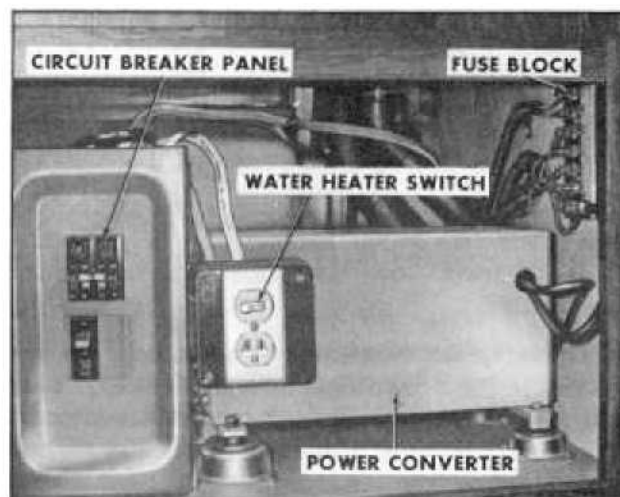

Living Area Electrical Compartment

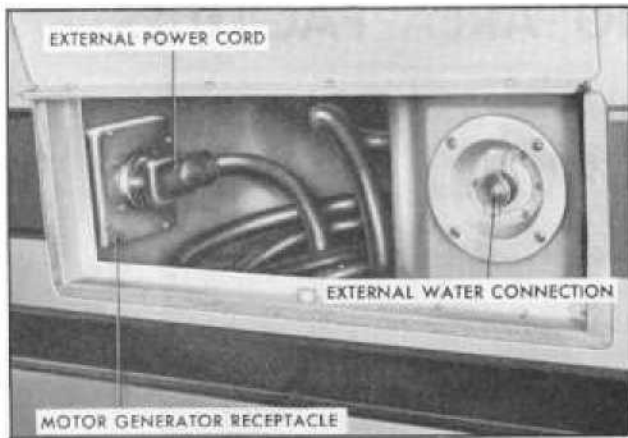

External Utilities Compartment

generator is running, and change it to 12-volts which powers much of the MotorHome. It will also charge the auxiliary (living area) battery any time 120-volt current is being received. The unit is located in the living area electrical compartment, next to the hall closet.

All switching operations in the power converter are automatic. It should remain plugged in at all times.

CAUTION

Do not use living area electrical compartment as a storage area. The converter must have a free flow of air through and around the unit. If air flow is restricted, the converter could overheat which could result in malfunction and permanent damage. Do not let the unit get wet, but do keep it as clean as possible to help assure its long life. The converter can be cleaned with low pressure air (30 PSI maximum) if necessary.

EXTERNAL POWER

The external utilities compartment located in the left side of the MotorHome contains the 21-foot power cord used for external power connections.

To make an external power connection, remove the cord from the compartment and plug it into a suitable power receptacle. All internal switching will take place automatically. When disconnecting from an external power source the power cord should be plugged into the motor generator receptacle within the external utilities

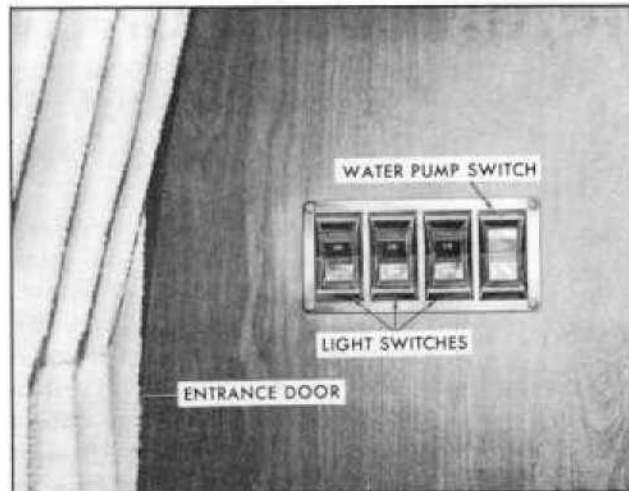

Light Switch Panel (Typical)

compartment. This connects the motor generator to the MotorHome electrical system. If the vehicle is not equipped with a motor generator simply coil the power cord neatly within the external utilities compartment.

Your MotorHome's external power cord contains two 120-volt circuits, rated to carry 40 amperes total. The electrical connection to be used must be suitable for these requirements. If the receptacle is designed to mate with the prongs on the power cord plug, the electrical connection can be expected to **CARRY RATED LOAD**. It is recommended that the power cord not be plugged in if the receptacle is not designed for your plug. In this event you can use your optional motor generator.

CAUTION

If the available power supply is other than 120/240 volt, 60 cycle rating, or is not properly grounded, it is essential that no attempt be made to plug in. Your MotorHome's electrical system is not designed for such electrical systems and connection could result in serious personal injury or property damage.

LIGHTING SYSTEM

All the lighting throughout the MotorHome is on the 12-volt system. Some of these lights contain a three-way switch which allows a choice in the amount of light given off. The switches to these lights are located on the light fixture itself.

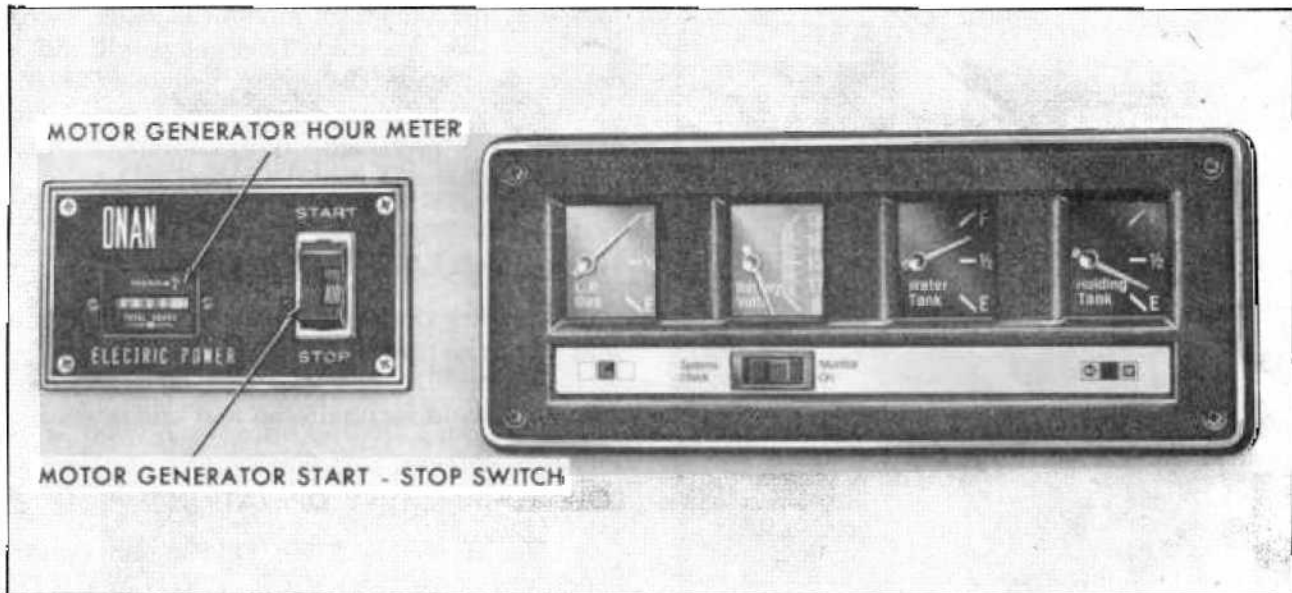

Monitor Panel and Motor Generator Switch

A panel of light switches is located near the entrance door. These switches operate the porch light, the kitchen light, the aisle floor light, and the water pump switch.

MONITOR PANEL

The MotorHome Monitor Panel is a series of four gauges located at eye level in the living area. Included are:

- **L.P. GAS**—This gauge is designed to indicate the amount of liquid petroleum gas remaining in the tank.
- **BATTERY VOLTS**—During operation, the indicator should remain in the center segment of the dial to indicate normal battery condition. If the indicator shows less than 11-volts, an under-charge condition exists in the living area battery and a recharge is required.
- **WATER TANK**—This gauge is designed to indicate the amount of water remaining in the living area water tank.
- **HOLDING TANK**—This is designed to indicate content level in the holding tank. Never allow this gauge to reach the "FULL" mark. If the holding tank is overfilled the overflow will back up through the bathroom shower drain.

NOTE: As of time of publication of this manual, the vehicle may not be equipped with a holding tank sending unit because final certification of

this unit has not been received. Therefore holding tank gauge may not register.

These gauges are activated by a "ROCKER" switch located on the face of the panel. This switch has three positions; "ON," "OFF," and "MOMENTARY ON." An indicator light glows when gauges are operating.

ONAN MOTOR GENERATOR

IMPORTANT: Before operating motor generator see the carbon monoxide caution at the beginning of this section.

The motor generator will allow operation of all 120-volt appliances without an external power connection, thus allowing the vehicle to be independent of an external power source. The motor generator is located in an exterior compartment in the left rear corner of the vehicle.

The unit is mounted on slides and can be pulled out like a drawer for ease in servicing the unit. To slide out the unit depress the buttons on the two latches. Then pull up on safety latch in upper right-hand corner and pull unit out.

OPERATING INSTRUCTIONS

The unit can be started from inside the MotorHome by using the remote switch which is located at eye level on the side of the refrigerator. A START-STOP switch is also located on the right side of the generator.

Before starting the motor generator the external power cord must be plugged into the

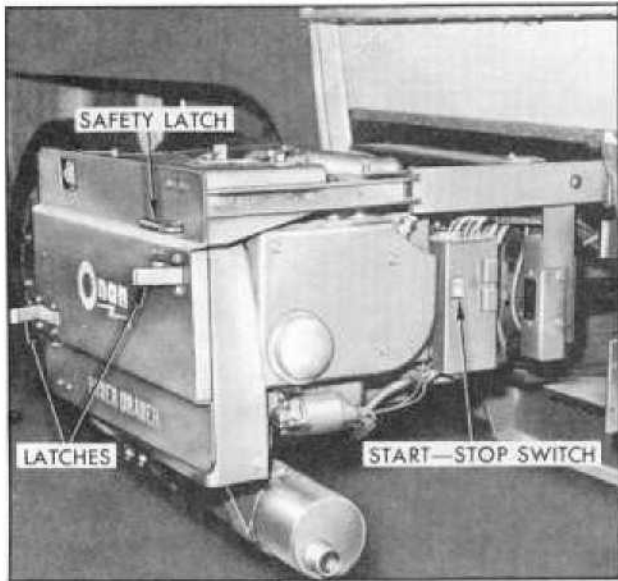

Onan Motor Generator

motor generator receptacle. Both of these components are located in the external utilities compartment on the left side of the vehicle. Be sure the crankcase has been filled with oil to the "F" full mark on the dipstick. Check oil only when the motor generator is not operating.

The remote **START-STOP** switch is a three-position rocker switch. By pressing the top half of the switch the starter on the motor generator will be activated, hold in the switch until the unit is started. The switch should then be released. When the motor generator is running the small amber light next to the switch will be lit. To stop the unit depress the bottom half of the switch, and hold in until the unit comes to a full stop. The **START-STOP** switch on the unit itself operates in a similar manner.

IMPORTANT: If the motor generator has been running with a load connected, disconnect the load and allow it to run for a few minutes (with no-load connected) before pushing **STOP** button.

The circuit breaker on top of the unit will trip when the demand for electricity in amperes exceeds the motor generators capabilities. If the circuit breaker does trip, remove part of the electrical load and reset the breaker.

HOURLY METER

Located to the left of the **START-STOP** switch is the **HOURLY METER**. The **HOURLY**

METER indicates total amount of hours motor generator has operated. This gauge will aid in determining when the motor generator should receive periodic inspections, maintenance and service parts replacements in conjunction with the Maintenance Schedule folder.

HIGH TEMPERATURE OPERATION

Make sure that nothing obstructs air flow to and from the unit.

Keep cooling fins clean. Motor generator housing should be unaltered and undamaged.

LOW TEMPERATURE OPERATION

1. Use correct SAE No. Oil for temperature conditions (see **SERVICE AND MAINTENANCE** section later in this manual to determine proper weight oil). Change oil only when engine is warm.

2. Keep fuel system clean and battery in well charged condition.

LOW OIL LEVEL

If motor generator suddenly stops during a tight turn or sudden stop of the MotorHome, the cause is most likely a low oil level. The unit is designed to shut-down when oil level is abnormally low. Before attempting to restart unit, check oil level and correct as necessary.

DUSTY AND DIRTY OPERATION

1. Keep unit clean. Keep cooling system clean.

2. Service air cleaner as required.

3. Change crankcase oil and filter more often than normal.

4. Keep governor linkage clean.

FUEL

The motor generator's fuel is supplied from the vehicle's main fuel tank.

NOTE: The motor generator may be operated while the vehicle is underway. However, the vehicle's gasoline supply will be depleted at a faster rate.

LIVING AREA WATER SYSTEM

Your GMC MotorHome is equipped with its own self-contained water system. Refer to "Water System Schematic." The water tank and pressure pump is located at the right rear corner of the MotorHome. The water pump switch is located near the entrance door.

Water pressure is maintained by a 12-volt water pump which is designed to automatically maintain enough pressure to ensure a steady water flow. A pressure switch is located at the water pump to maintain line pressure between 20 psi and 30 psi.

Information on how to sanitize, drain, and maintain your vehicle's water system can be found in the SERVICE AND MAINTENANCE section.

IMPORTANT: Do not attempt to increase water pressure with high pressure air. Be sure the water pump is turned "OFF" when the water tank is empty.

FILLING WATER TANK

FILLING FROM A PRESSURIZED WATER SYSTEM

Type 1

1. Remove the plastic cap at the hose connec-

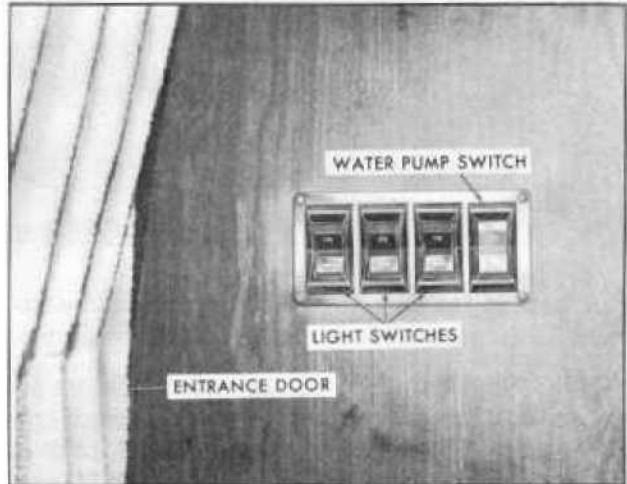

Light Switch Panel (Typical)

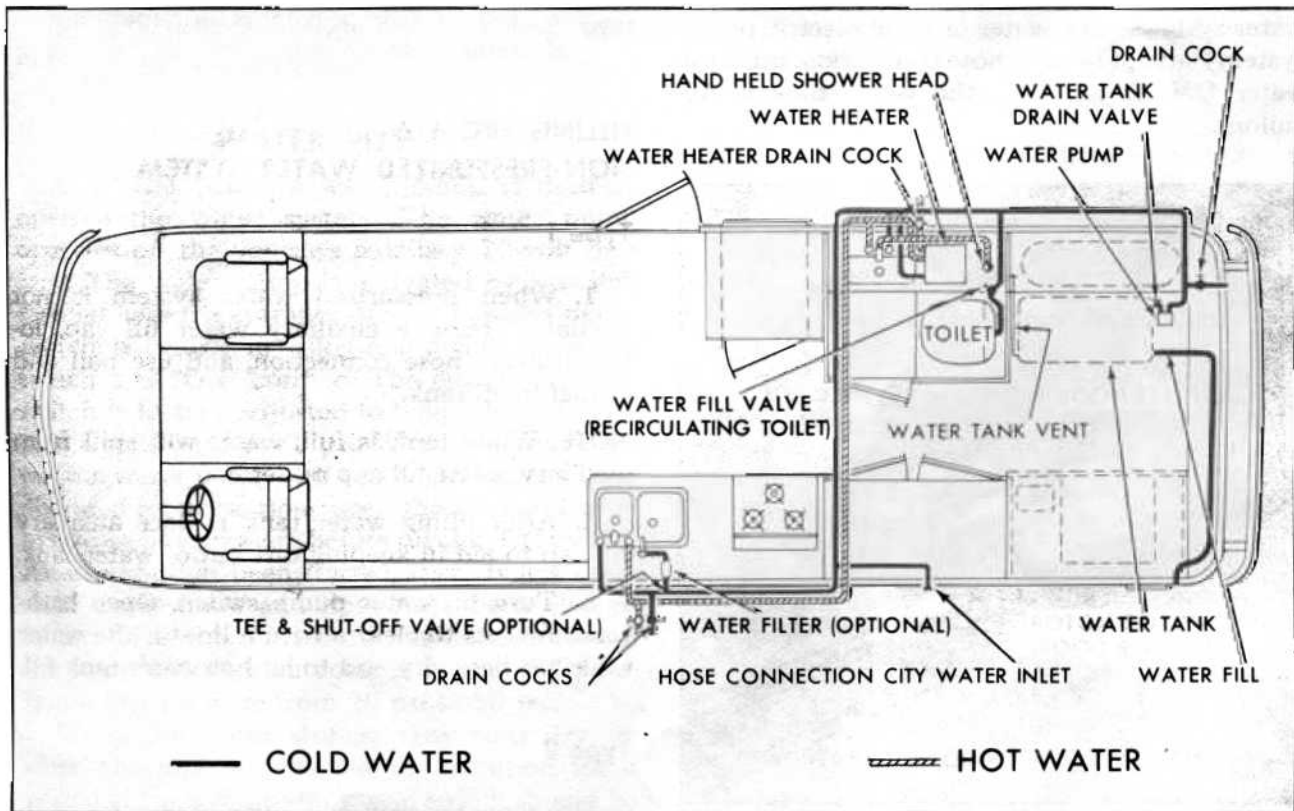

Living Area Water System (Typical)



Location for Filling Water Tank (Type 1)

tion located inside the LP gas storage compartment at the right rear corner of the MotorHome.

NOTE: When using the hose connection to fill water tank from pressurized water system, remove the auxiliary water fill cap. When tank is full, water will spill from auxiliary water fill cap outlet.

2. When filling water tank from a pressurized water system (city water or rural electric pump system) attach hose to hose connection and turn water ON. Capacity of the water tank is 40 gallons.

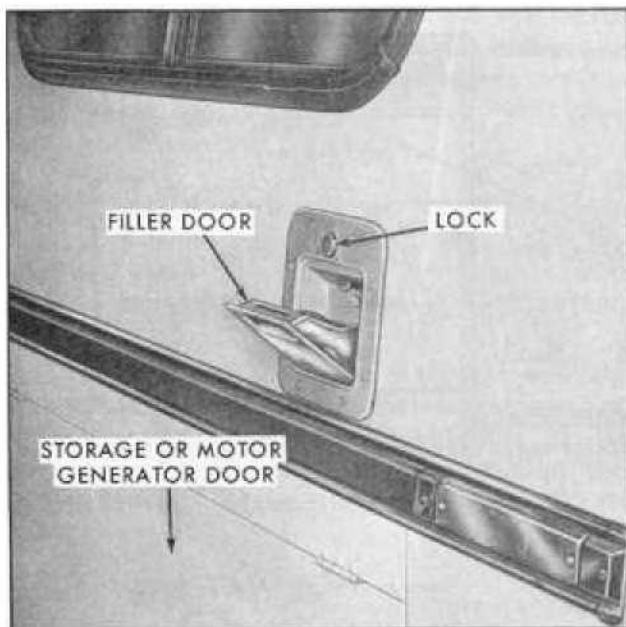

Location for Filling Water Tank (Type 2)

3. When disconnecting hose, be sure to install plastic cap at hose connection and replace auxiliary water fill cap to aid in keeping dirt out of water tank.

4. Turn on water pump switch. Open bathroom faucets to clear air from lines if the water tank has been dry and to let hot water tank fill.

Type 2

1. Carefully remove any accumulated foreign material (dirt, salt, etc.) from filler door with the aid of a clean cloth.

2. Unlock filler door and open.

3. Insert hose into top of filler opening and turn water ON. Capacity of the water tank is 40 gallons.

NOTE: When tank is full, water will spill from the water filler opening.

4. Turn on water pump switch. Open bathroom faucets to clear air from lines if the water tank has been dry and to let hot water tank fill.

CAUTION

Always lock water filler door after filling tank to help prevent contamination of water system.

FILLING FROM A NON-PRESSURIZED WATER SYSTEM

Type 1

1. When pressurized water system is not available, remove auxiliary water fill cap, located above hose connection, and use pail and funnel to fill tank.

NOTE: When tank is full, water will spill from auxiliary water fill cap outlet.

2. After filling water tank replace auxiliary fill cap to aid in keeping dirt out of water tank.

3. Turn on water pump switch. Open bathroom faucets to clear air from lines if the water tank has been dry and to let hot water tank fill.

Type 2

Use same procedure as given earlier, for "Filling From A Pressurized Water System—Type 2."

EXTERNAL WATER CONNECTION

Connecting to a park or city water supply is easily accomplished. It is not necessary to drain the vehicle's water system.

1. Remove the plastic cap at the hose connection located in the external utilities compartment.
2. Attach hose and turn ON external water supply.
3. When disconnecting hose, be sure to install plastic cap at hose connection to aid in keeping dirt out of water lines.

IMPORTANT: To avoid possible damage to external water connection components, from freezing, when not being used—perform the following:

- a. Remove access cover from lower shelf in closet.
- b. Open drain valve for external water connection (See Page 90).
- c. At the external water connection, momentarily depress the check valve button to allow this portion of plumbing to drain.
- d. Install hose connection cover.
- e. Close drain valve and install access cover in closet.

WATER PUMP

A 12-volt pressure water pump is used to operate the water system. The water pump operates off the vehicle's auxiliary 12-volt battery. The water pump is activated by a switch located near the entrance door. The water pump switch is amber in color and lights up when switch is in "ON" position. The pump's pressure switch is factory adjusted to hold a line of pressure from 20 psi to 30 psi. When initially starting the water pump or if the pump has not been operated for some time, open the kitchen faucet to release line pressure before turning ON switch. After pump has been started, leave faucet open until water flows and lines have been cleared of air. Once this procedure has been followed, the pump will work automatically and will maintain a line pressure from 20 psi to 30 psi.

When the water storage tank runs dry, or when the unit will be out of operation for a period of time, the water pump switch should be turned OFF.

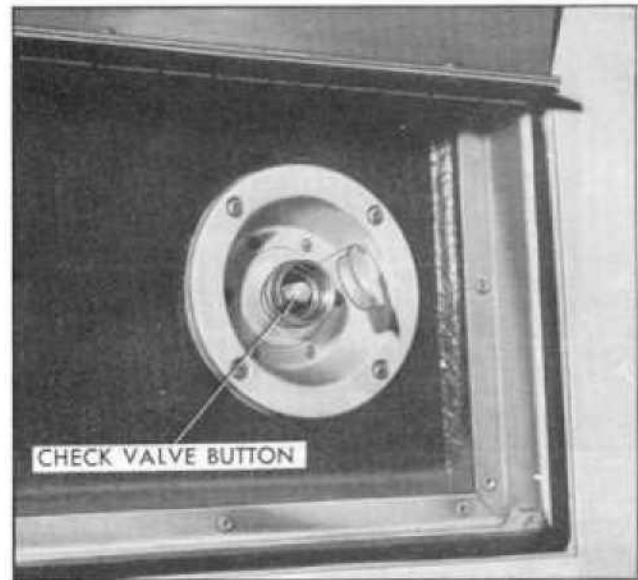

External Water Connection

It is a good idea to travel with the pump switch OFF unless water is needed. The pump runs quietly and may not be heard.

If the following maintenance problems should arise, follow the step-by-step procedures. If they do not solve the problem consult a GMC Motor-Home dealer.

1. Pump will not prime (it should do this automatically):
 - a. Check to be sure there is water in the tank.
 - b. Check to be sure battery is not run down.
 - c. Check for kinks in the inlet hose.
 - d. Check for air leaks at inlet fittings. If air is leaking into inlet fittings, tighten fittings or apply clamps as necessary.
 - e. Check for clogged line.
2. Pressure drops:
 - a. Check faucets and connections for leaks.
 - b. Make sure faucet aerators are clean.
 - c. Check to be sure there is water in tank.
 - d. Check to be sure the battery is not run down.
3. Pump runs when there is no apparent demand for water:
 - a. Check all faucets and fixtures to make sure they are shut off and not leaking.
 - b. Check lines for leaks.
 - c. Make sure there is water in the tank.

Refer to the Maintenance Schedule folder for water pump belt checking interval. Adjustment

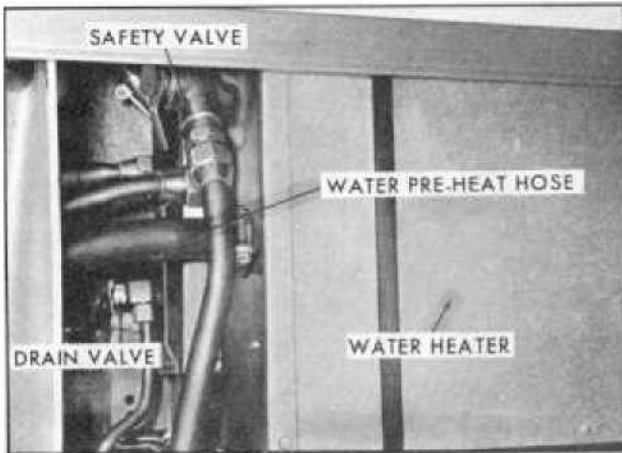

Water Heater

is required if there is more or less than 1/4-inch slack in the belt as it is depressed by your finger between the pulleys. To adjust belt tension, loosen the two (2) nuts on the end of the motor, move the motor to provide proper tension and tighten nuts.

WATER HEATER

Your GMC MotorHome is equipped with a 6-gallon 120-volt AC hot water heater with a factory setting of 150°F. The hot water heater is located behind the lower storage compartment in the bathroom. It is equipped with a drain cock to be used when draining the water system. An "ON-OFF" switch for the water heater is located in the living area electrical compartment. The switch is located in this compartment to prevent the possible hazard of operating the switch with wet hands; i.e., trying to operate the switch after starting to wash or shower.

If no hot water is being supplied, check to be sure that water heater switch is turned "ON." If hot water is still not being supplied, remove

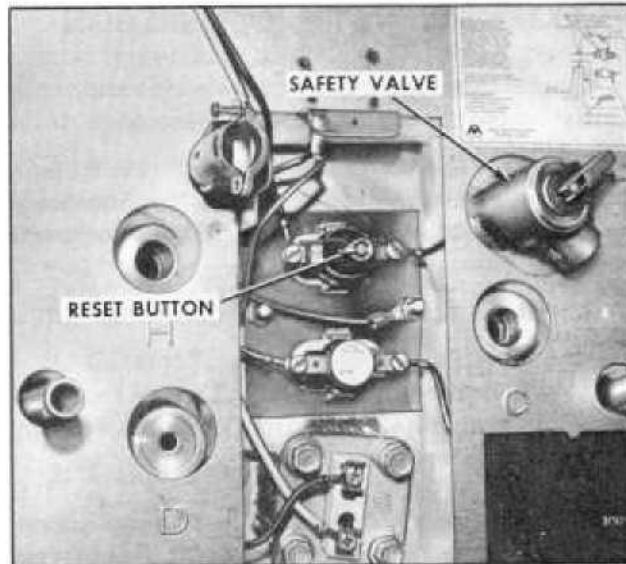

Water Heater Reset Button

access cover from end of water heater and depress reset button.

CAUTION

Do not operate water heater unless there is water in the living area water system. If unit is operated without water this will result in damage to the heating element.

Your GMC MotorHome is equipped with a hot water heater pre-heater which has hot water available if the engine is running and at the normal operating temperature. This is accomplished by circulating engine coolant through hoses to the water heater and back to the engine. Otherwise the hot water heater operates on 120-volt AC power from the motor-generator (if equipped) or from an external 120-volt AC source (see "External Power" previously in this section for additional information).

KITCHEN FACILITIES

ALL-ELECTRIC REFRIGERATOR

The All-Electric Refrigerator will operate either on 12-volts DC or 120-volts AC. It operates on the same principle as the standard domestic refrigerator. This dual-voltage refrigerator automatically switches from AC to DC or DC to AC. When a power supply of 120-volts

AC is connected to the vehicle, the voltage selection relay is energized and disconnects the unit from DC operation. When the AC supply is disconnected, the refrigerator automatically reverts to DC operation.

Turning the thermostat knob to the "OFF" position will stop operation of the refrigerator.

OPERATION

A single thermostat controls the operation of the refrigerator. This thermostat is mounted at the rear, inside the refrigeration cabinet below the freezer compartment. The knob is marked "OFF, 1, 2, 3, 4, 5." The nearer the knob is set to "5," the colder the temperature becomes in the cabinet.

Once the desired temperature is reached, the thermostat will control the cabinet temperature equally well on either voltage supply.

There is a circuit breaker incorporated in the 12-volt circuit of the refrigerator. It is located behind the kick plate below the refrigerator door. When the circuit breaker opens a small light will come on beside the breaker. The circuit breaker is reset by pushing IN on the red button next to the light.

OPERATING TIPS

The following operating suggestions will serve as a guide in operating your unit efficiently during 12-volt DC (battery) operation:

1. In order to conserve battery power it is advisable to set the thermostat knob at the lowest setting that will provide adequate refrigeration. This practice will reduce the running time of the refrigerator and draw less current from the battery. A setting of "3" is a normal position.

2. Always operate the refrigerator with a 120-volts AC source connected to the Motor Home when available, especially during initial start-up of the unit. Depending upon the ambient temperature, the initial start-up may require one to two hours continuous operation before refrigeration temperatures are attained and unit cycling begins.

3. Never employ "Quick Chargers" to the battery unless the thermostat is set to "OFF" or the 12-volt DC leads to the refrigerator are disconnected. Damage will occur if the high voltage of the "Quick Charger" is permitted to reach the DC circuitry of the refrigerator.

Leveling

The All-Electric Refrigerator will operate efficiently 30 degrees off-level so it is not necessary to level the refrigerator.

Defrosting

Since ice and frost are poor heat conductors, a frost build-up of $\frac{1}{4}$ " or more should be

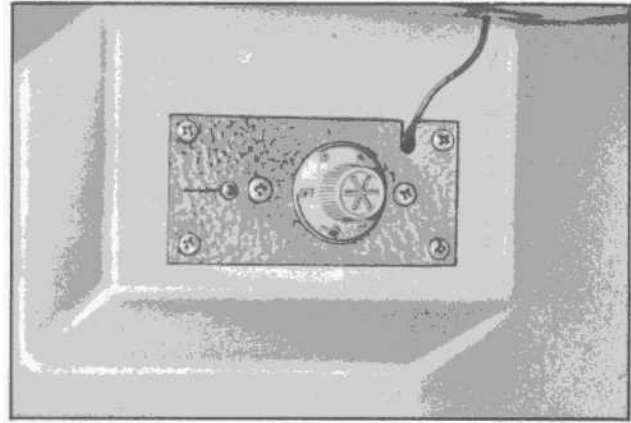

All Electric Refrigerator (Control Panel)

avoided. It decreases overall cooling capacity and increases power consumption. To lessen frost accumulation avoid putting hot or steaming food in the refrigerator.

To defrost the refrigerator, turn the thermostat to the "OFF" position. When accumulated ice has melted, the water can be removed from the drip pan under the freezer compartment.

Cleaning

The cabinet interior should be cleaned regularly. Remove shelves and wash the lining with lukewarm water to which a mild soap may be added. Dry thoroughly, especially around door frame and door gasket. Warm water only should be used to wash the cooling evaporator, ice trays and shelves. Never use strong chemicals or abrasive cleaning materials on any part of the cabinet.

To Shut Off Refrigerator

When refrigerator is not in use set the thermostat to "OFF," remove water from drip pan, remove all food-stuffs from cabinet, and leave door slightly ajar to permit air circulation.

KITCHEN RANGE/OVEN

IMPORTANT: Before operating the Range/Oven see the carbon monoxide caution at the beginning of this section.

Always wait 5 minutes before relighting Range/Oven to allow excess gas to dissipate.

Recreational vehicle range/ovens differ from conventional residential units in several ways:



Power Range Hood

1. The units are more compact.
2. The units are equipped with thermostat control which allow you to manually shut off the gas to the oven pilot when traveling.
3. Clips are provided for the top burner grates and oven rack to help prevent rattles and dislodgement while traveling.

Any time the range/oven is in operation, the power range hood fan should be operating to help ensure proper ventilation.

In order to operate the range/oven the gas supply must be turned on at the L.P. gas tank.

CAUTION

The Range/Oven should not be used when the vehicle is moving, and the LP gas should be turned off at the LP gas

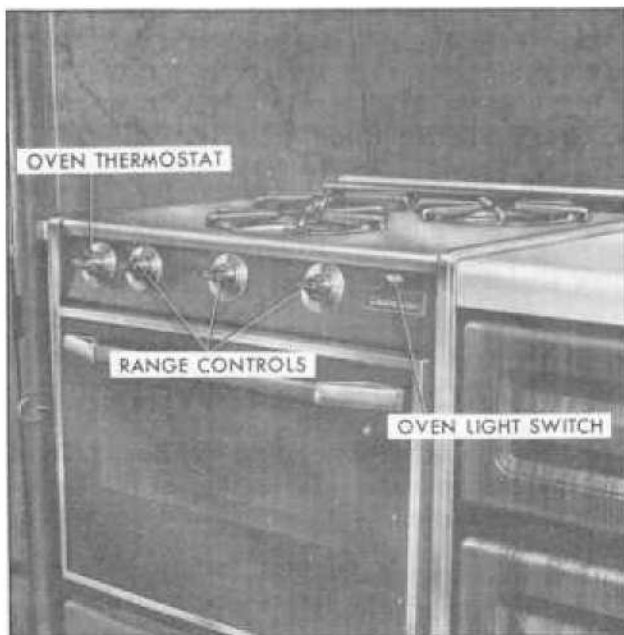

Range/Oven Controls

tank. The burners or pilot lights may blow out creating a fire or explosion hazard. In addition, a sudden movement of the vehicle could throw utensils or scalding liquids from the stove which could result in serious personal injury or property damage.

OPERATION OF 3-BURNER UNIT

The 3-burner range/oven has two pilots—one for the 3 range burners and one for the oven.

Pilots

1. Turn on power range hood fan.
2. Be sure manual control valve at LP gas tank is fully open (see page 80 for location of valve).
3. Be sure all knobs are in the "OFF" position. The oven thermostat should be in the "PILOT OFF" position.
4. Lift cook top panel and turn range/oven manual valve and range pilot shut off valve to ON position.
5. Light range pilot with a match as shown.
6. Depress the oven thermostat and turn counterclockwise to OFF position.
7. Open the oven door, allow the compartment to ventilate, then light the oven pilot with a match. A small flame should be noted at the top of the pilot burner. After the initial light-up, it may take a minute or so to clear the air from the line so the flame stays lit.

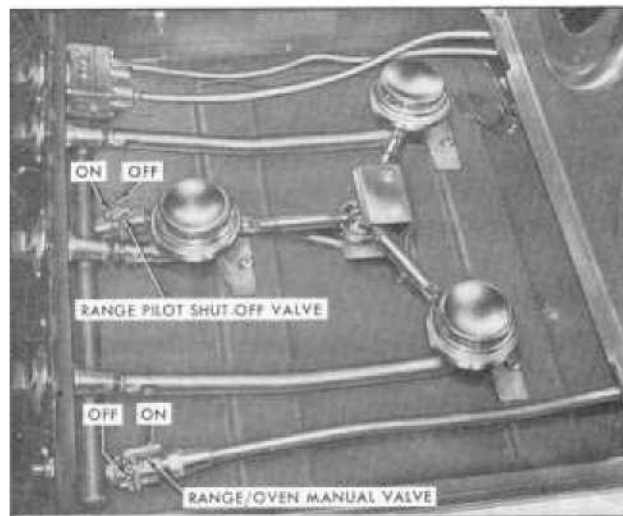

Range/Oven LP Gas Valves

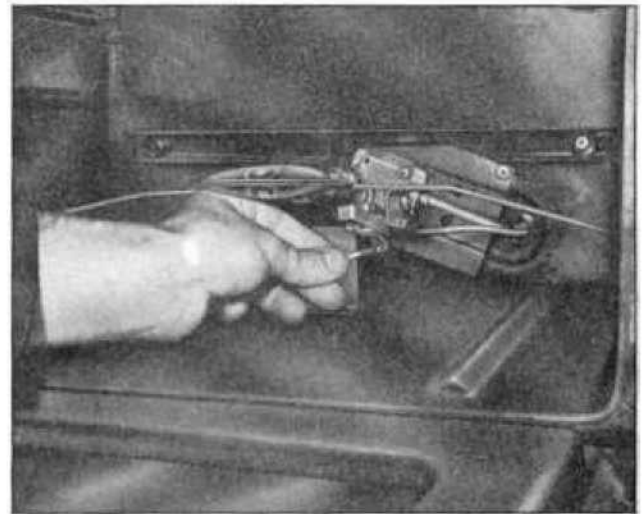

CAUTION

When lighting pilots, **BOTH** pilots must be lit, even if plans are to use just one cooking means. Once the oven thermostat is moved from the "PILOT OFF" position and the range pilot shut off valve is in the ON position, gas will issue from both range and oven pilots. Failure to light both pilots could result in fire or explosion caused by accumulating LP gas.

8. The oven pilot is non-adjustable. The range pilot adjustment screw is located behind the range pilot shut off valve.

RANGE

1. Be sure power range hood fan is operating.
2. Push control knob in and turn gas on counterclockwise all the way to get gas to the burner.
3. As soon as the burner lights, flame may be reduced to the desired height.
4. To turn off the burner, turn the control knob clockwise all the way to the "OFF" position. The knob is designed to lock in this position.

OVEN

1. Be sure power range hood is operating.
2. To turn on the oven light, push in oven

light button located at the right side of the knob panel. Push again to turn out.

3. To light the oven burner, depress and turn the thermostat dial counterclockwise to the desired temperature setting. It will take approximately 45 seconds before the safety valve will open and the oven burner ignite.

4. When through with oven, turn the thermostat dial to the "OFF" position. In this position the oven pilot will remain lit.

5. When traveling or when the MotorHome is not in operation; return the thermostat dial to the "PILOT OFF" position and turn range/oven manual valve and range pilot shut off valve to OFF position. This should turn off the gas to the range and oven pilots.

- **POWER RANGE HOOD FILTER**—It is important that the power range hood filter be inspected frequently and cleaned as needed. To clean filter, remove retaining nuts at power hood switches, remove filter and wash in hot, soapy water. Rinse thoroughly and reinstall.
- **GENERAL**—Regular cleaning with a warm detergent solution and a soft cloth will keep your range looking bright and new. This should be done as soon as range cools.
- **CHROME**—To keep the mirror bright finish, wipe with a damp cloth and dry thoroughly.



Kitchen Sink and Faucet

Stubborn stains may be removed with lemon juice, vinegar, or chrome polish.

NOTE: Properly clip the top burner grates and oven rack after cleaning to help prevent them from rattling or becoming dislodged while the vehicle is underway.

- **GLASS**—Wipe cooled glass with detergent and hot water. Rinse and polish with a soft cloth.
- **BROILER PAN**—Remove the broiler pan from oven immediately after use. Drain fat. Sprinkle rack with detergent and cover with wet paper towels and let soak before washing in hot soapy water.
- **OVEN INTERIOR**—Clean as soon as possible after use when the oven is cool. Grease spatters that are allowed to become hard and baked on become very difficult to remove. Care must be taken to avoid bending the thermal sensing element, which could cause a variation between the oven temperature and the dial setting. If oven cleaners are used, protect aluminum gas tubing, thermostat sensing element and electrical components from the cleaners. Thoroughly rinse oven with a solution of one tablespoon vinegar to one cup of water and wipe dry.
- **TOP BURNERS**—Top burners may be cleaned with a detergent solution. If any burner port should become clogged, clean

with a toothpick. Never use pins or other metal objects to clean the ports, as they may become enlarged. If the burner is washed in a sink, dry immediately by shaking off all excess water and lighting the burner until all water has evaporated.

OPERATING TIPS

- The Range/Oven is not designed for and should never be used as a space heater. Do not leave the oven door open while the oven is on.
- Do not operate range/oven while traveling or while refueling your vehicle at a gasoline service station. The pilot lights or burners may ignite gasoline fumes.
- Do not leave the top burners on without a utensil for any length of time. Overheating of the grates may cause the porcelain enamel to craze and chip.
- Your range has an oven light bulb, do not clean it while hot. After it has cooled, wipe it clean with a damp cloth.
- Do not use broiler area to store utensils as the oven burner and pilot may become damaged, or knocked out of proper alignment.

KITCHEN SINK AND FAUCET

Your GMC MotorHome is equipped with a stainless steel double bowl sink with a swing spout and adjustable spray spout. To operate single-handle faucet lift the faucet handle to turn water on and adjust water temperature by moving faucet handle left or right. For cleaning and care of the stainless steel sink see the **APPEARANCE CARE** section later in this manual for more information.

WATER PURIFIER

An optional water purifier is located at the kitchen sink. The purifier cartridge assembly is located in the cabinet below the kitchen sink. When unit is new or after cartridge assembly replacement, open the water purifier faucet. Allow the water to run for about five minutes. A slight grey color in the water is designed to disappear after several minutes.

PURIFIER CARTRIDGE REPLACEMENT

1. Close inlet valve to purifier cartridge assembly. Disconnect inlet line at cartridge assembly.
2. Disconnect outlet line to faucet at cartridge.
3. Replace cartridge assembly.

NOTE: Under normal family usage the purifier cartridge assembly is designed to last for two years. Interval for replacement of cartridge may be determined by restriction of water flow at purifier faucet. Filter cartridge is designed to restrict water flow when replacement is required.

4. Connect inlet and outlet lines at cartridge assembly. Open inlet valve.
5. Open the purifier faucet for five minutes.

BATHROOM FACILITIES



STANDARD TOILET

The standard toilet is a fresh water sanitation system. It uses a pressure flushing system wherein water cleans the bowl with each flush and washes contents directly into the holding tank. This water injection produces a swirl effect and uses a measured amount of water to rinse efficiently. The unit is a self-cleaning type designed with an odor and gas tight teflon seal which closes off the holding tank when not in use. Since every flush uses fresh water, chemical additives are not mandatory.

OPERATING INSTRUCTIONS

1. After use, depress flush pedal located at base of toilet. This will automatically flush and refill toilet with water. Keep pedal depressed until bowl is cleansed and release.
2. If you wish to add water to bowl without flushing, depress the water pedal. Hold depressed until desired water level is reached and release.
3. Cleaning of toilet bowl can be accomplished by using any high grade, non-abrasive cleaner. Highly concentrated or high acid content cleansers might damage rubber seals.
4. The standard toilet dumps directly into the vehicle holding tank. Therefore it is recommended that holding tank be drained at regular intervals to avoid overfilling. If vehicle is not equipped with a Thermasan System, a suggested drain interval would be whenever refilling living area water tank.



Standard Toilet

OPERATING TIPS FOR EITHER TOILET

1. Do not put facial tissue, automotive type anti-freeze, coffee grounds, laundry bleach, or highly concentrated or high acid content household cleaners in your holding tank or toilet sys-

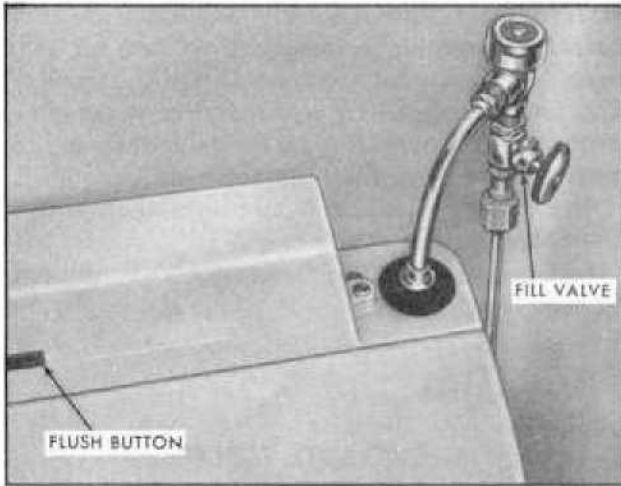

Recirculating Toilet Controls

tems as they may damage the plastic or rubber parts in the system.

2. Special non-toxic non-flammable deodorizing chemicals can be added to holding tank, but are not required. Follow directions on container.

3. Most toilet tissues are usable in system. Several special tissues designed to break down and flow away readily are available.

4. Keep your holding tank drain valve closed when parked and connected to a sewer system. By doing this, enough fluids are put into the holding tank to entirely wash away the waste in the holding tank when drain valve is opened.

5. Details on winterizing or draining vehicle holding tank are covered in the **SERVICE AND MAINTENANCE** section of this manual.

RECIRCULATING TOILET

The optional recirculating toilet operates by recirculating a chemical solution. The advantage is that you are conserving water when flushing and also by not adding volume to your holding tank. The toilet operates on 12-volt DC.

OPERATING PROCEDURES

Initial Flush Charge

1. Be sure handle on dump valve is pushed in.
2. Open fill valve, filling toilet to the charge level as indicated by the letter "C" on prism. This will be approximately 3 gallons. Close the fill valve.

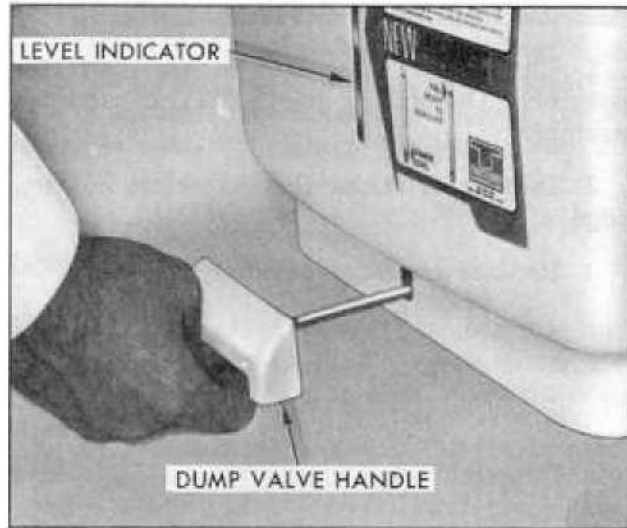

Dumping Waste Contents of Recirculating Toilet

3. Add recirculating toilet chemical as recommended by manufacturer of chemical.

To Flush

Depress flush button. Timer will provide a seven second flush cycle.

To Empty Toilet Into Holding Tank

1. When prism indicator shows level at the letter "F" it is time to empty the toilet. When full, toilet holds approximately seven gallons. The toilet may also be emptied when the blue chemical solution turns green as this is an indicator that the active ingredients are used up.

2. Pull the dump handle all the way out. The handle is located near the floor at the center of the front of the toilet. When toilet is empty, as indicated by the prism, push the handle back in and recharge toilet as directed under "Initial Flush Charge" described previously.

CLEANING TIPS

1. There are several excellent cleaning compounds that may be used. Be sure to read the label to be sure compounds will not damage plastic parts and tubing.
2. Recreational users advise it is best to flush the toilet before each use to aid in maintaining cleanliness.
3. Another aid to flushing is to lay some toilet tissue in the bowl just prior to use.

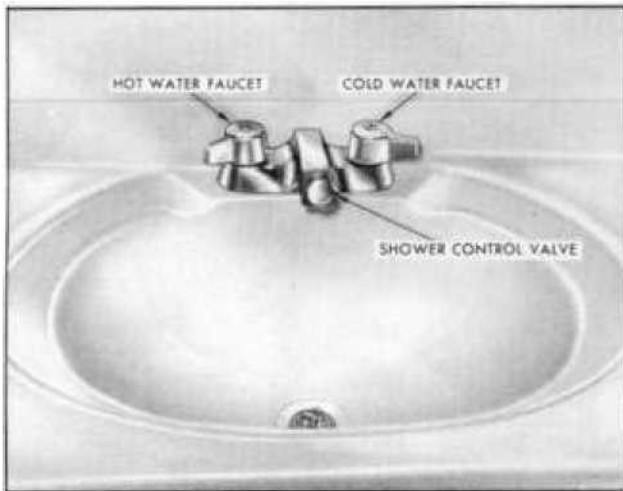

Bathroom Sink

BATHROOM SINK AND SHOWER CONTROL VALVE

Your MotorHome is equipped with a bathroom sink with an integral shower control valve in the spout.

With the shower control valve knob pushed in, the off position, water temperature may be adjusted prior to taking a shower. Once the desired temperature is set, remove the shower head from the wall and point towards the sink. Open the valve at the shower head, pull the shower control valve knob out and allow water to flow into sink until it warms to the desired temperature. Adjustments in temperature may be made as required.

Showers can take a lot or a little water. A suggestion would be to take a "camper's" shower. Wet yourself down, then turn off the water at the shower head, soap up and then turn water back on to rinse.

NOTE: Remove shower drain plug before taking a shower. Shower drain plug should be installed when shower is not in use.

SHOWER HEAD

The shower head and flexible hose mounts to a bracket on the bathroom wall. The valve in the shower head is shown in the on position. Pushing the shower head valve to the left will shut off the water.

NOTE: Leave shower head valve in off position when not in use to avoid getting showered unexpectedly when the shower control valve is turned on.

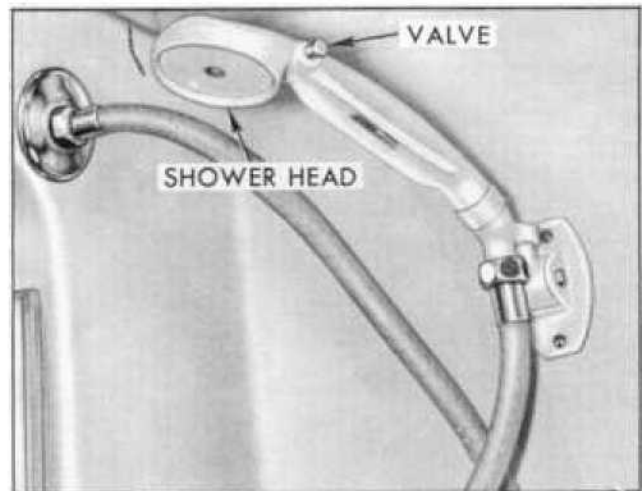

Shower Head

BATHROOM WARM AIR DUCT

Located on the bathroom wall next to the shower is the bathroom warm air duct--Type 1. This air duct may be adjusted to desired direction and may also be adjusted to a open or closed position. The Type 2 warm air duct is non-adjustable and is located near the bottom of the shower compartment. When equipped



Bathroom Warm Air Duct (Type 1)

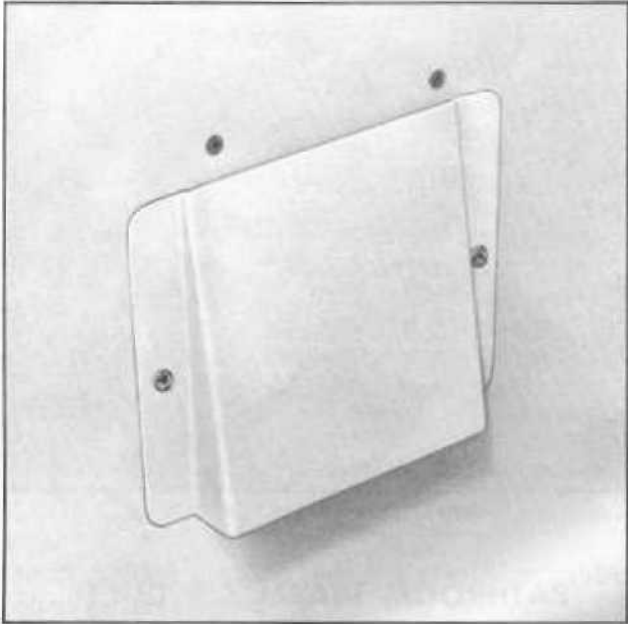

Bathroom Warm Air Duct (Type 2)

with either Type 1 or Type 2 warm air duct, warm air will be supplied when furnace is operating.

NOTE: An auxiliary furnace blower is located beside the closet with Type 1 air duct or behind the kitchen range with Type 2 air duct.



Bathroom Exhaust Fan

BATHROOM EXHAUST FAN

Located in the ceiling of the bathroom is the bathroom exhaust fan. Push upward to open and pull downward to close. Power vent button switch is located at corner of vent.

VENTILATION

WINDOWS

The side windows in the driver's compartment are operated by squeezing the latch and sliding the window to the rear.

The side windows in the living area are equipped with screens. The windows are operated by sliding the screen out of the way to gain access to the window latch. Then squeezing the latch and sliding the window to the open or closed position as desired.

CEILING VENTS

The purpose of the ceiling vents is to allow warm air to escape that may accumulate at ceiling level when the vehicle is parked in the

sun. The opening of a ceiling vent and a window will aid in removing condensation from the windows.

The vents are crank-operated from inside the MotorHome. In rainy weather it is possible to leave the ceiling vents open slightly for ventilation without entry of water into the Motor Home (depending upon the magnitude and direction of rain).

NOTE: All windows and roof vents must be tightly closed when operating the air conditioner or furnace to obtain maximum cooling or heating.

Power fans are available for the ceiling vents. These will increase the efficiency of the vent. They are operated by the button switch at the corner of the vent.

ROOF MOUNTED AIR CONDITIONER

The controls for the unit are mounted in the ceiling of your MotorHome. This unit can provide either cooling or air circulation.

The unit is operated by setting the thermostat knob to the desired temperature setting. The blower fan switch is then set at the desired setting:

Hi Fan High Fan Speed Only
Med Fan Med Fan Speed Only
Low Fan Low Fan Speed Only
Hi Cool . . High Fan Speed with Cooling
Med Cool . . Med Fan Speed with Cooling
Low Cool . . Low Fan Speed with Cooling

Air distribution either from the front or rear of the unit, is controlled by the air distribution knob. Then place the adjusted louvers to the desired position.

The unit is shut down by placing the blower switch in the "OFF" position. This unit is equipped with a delayed start feature. When the unit is turned on, the fan will start, and in approximately two minutes the compressor will start. After shut down, unit will not start for approximately two minutes.

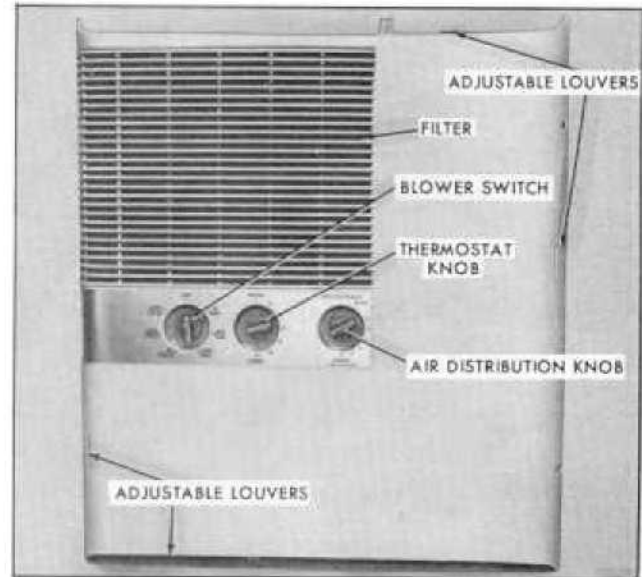

Roof Mounted Air Conditioner Controls

The air filter must be checked and cleaned frequently as required by use. Wash filter in warm soapy water, rinse, shake off excess water and allow to dry. (Do not use compressed air to dry filter.)

FURNACE

IMPORTANT: Before operating the furnace see carbon monoxide caution at the beginning of this section.

The furnace is located in the compartment under the kitchen sink and has 30,000 BTU capacity.

The furnace's electrical system is operated on 12-volt DC only.

SEQUENCE OF OPERATION

Whenever operating the furnace the window above it should be fully closed, to help avoid drawing carbon monoxide exhausted from its vent back through the window.

When the thermostat is adjusted to the desired setting, furnace blower motor is energized immediately. When the blower reaches minimum operating speed (approximately 2-3 seconds) the main burner of the furnace will ignite. The furnace will continue to run until the thermostat



Furnace Thermostat

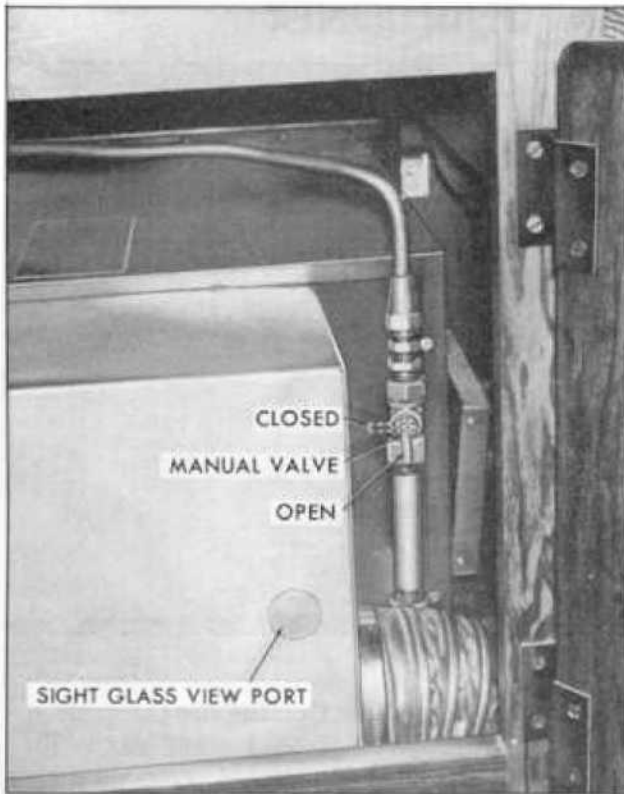

Furnace Manual Valve and View Port

is satisfied or is turned to a lower setting. When thermostat setting has been satisfied main burner flame will go out but the blower will continue to run for a short period of time and then shut off. When vehicle has cooled, thermostat will re-light furnace automatically.

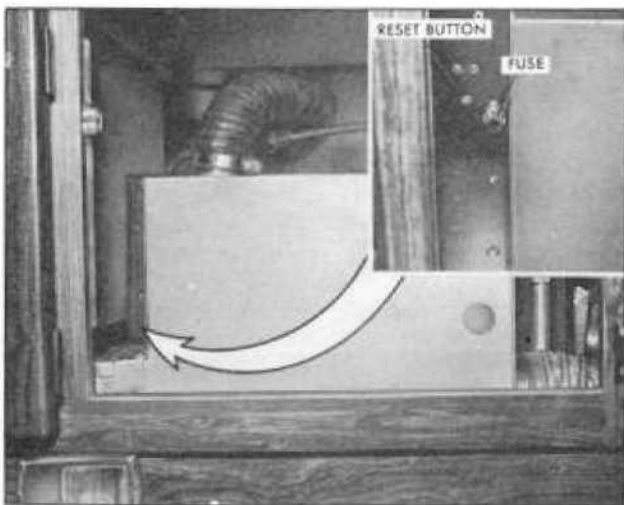

Location of Furnace Reset Button and Fuse

REMINDER: The furnace should not be used when the vehicle is underway, and the LP gas should be turned off at the LP gas tank.

OPERATING FURNACE

This furnace has no pilot light, but is ignited by an integral, solid state, direct-spark ignition system. No manual lighting is required.

1. Set thermostat, located in rear of Motor Home living area to "OFF" position.

NOTE: Be sure manual control valve at LP gas tank is fully open (see page 80 for location of valve).

2. Open furnace manual valve fully, located under sink at right side of furnace. Do not attempt to operate furnace with valve partly opened as proper operation depends on valve being fully open.

3. Set thermostat to desired setting, furnace will energize and continue to run until thermostat is satisfied or is turned to a lower setting.

NOTE: Refer to "FURNACE OPERATING TIPS" if furnace fails to ignite.

SHUTTING OFF FURNACE

- To shut off furnace set thermostat to "OFF" position and close manual valve.
- Always perform these steps as a precaution when the furnace will not be in use.

FURNACE OPERATING TIPS

If furnace fails to ignite it may be necessary to push the manual reset button, which is located next to the fuse receptacle at the front of the furnace—

1. Turn thermostat to lowest setting.
2. Open LP gas tank valve.
3. Open main furnace valve.
4. Press manual reset button on furnace.
5. Turn thermostat to a temperature above room temperature. Furnace should start.

NOTE: A rumbling or growling noise is not normal. Refer to "PRIMARY AIR ADJUSTMENT" if this occurs.

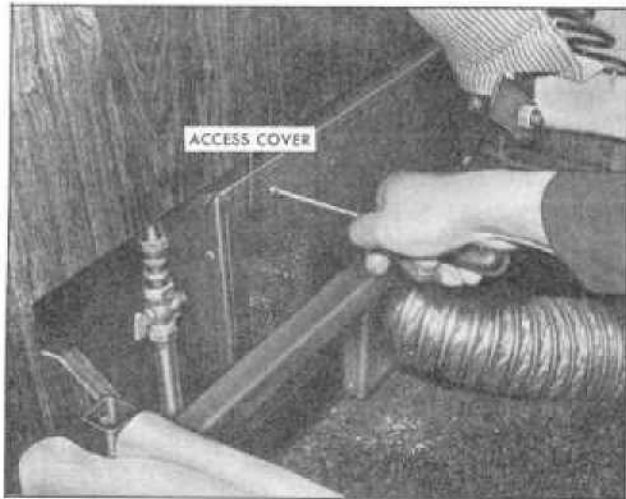

Removing Furnace Access Cover

6. Set thermostat to desired temperature and it will cycle the furnace on and off as the temperature inside the MotorHome satisfies the thermostat.

If furnace is noisy, rumbling burner or smoke or carbon at exhaust vent—

1. Faulty or broken electrode.
2. Improper primary air adjustment.

If thermostat calls for heat and furnace blower does not start—

1. Depress manual reset button.
2. Blown fuse. Check fuse in furnace and also fuse located in living area electrical compartment.
3. Dead auxiliary (living area) battery or loose wiring.

Blower runs for 30-60 seconds, then stops and requires manual reset before it will restart. Burner does not ignite—

1. LP gas tank low or empty.
2. LP gas tank valve or furnace manual valve closed.
3. Low voltage at furnace.
4. Loose electrical connection at electrode.
5. Faulty or broken electrode.

Blower runs 30-60 seconds, then stops and requires manual reset before it will restart. Burner does ignite—

1. Low fuel pressure.
2. Faulty flame switch.
3. Insufficient primary air.



Furnace Primary Air Adjustment

NOTE: Before pressing the reset button to reset the control circuit, a wait of 5 minutes is required, after the furnace has stopped, before the thermal relay will properly reset.

PRIMARY AIR ADJUSTMENT

Access to the burner assembly to adjust primary air is located at the bottom, right side of the furnace compartment by removing access cover.

NOTE: To gain access to right side of furnace, if vehicle is equipped with a davo, squeeze levers located under center of davo seat and raise seat.

1. Loosen hex lock nut slightly until burner adjusting rod can be turned with a screwdriver.
2. Start furnace and watch burner through sight glass view port in plenum. Decrease primary air to give a slightly yellow flame with green cones. The cones are formed at each of the ports in the burner. Then increase air slowly until the yellow disappears and the cones become sharply defined as blue.

NOTE: The total adjustment available, from one extreme to the other, is only about $\frac{1}{4}$ turn. Do not force adjusting rod past the stops.

3. Hold the adjusting rod in place and tighten the hex nut.
4. Recheck flame to see that it is still properly adjusted.

FURNITURE

DOUBLE DINETTE

The double dinette is adjustable and provides a normal sitting position, two intermediate sitting positions and a sleeping position.

NOTE: Use table leg to support dinette table when table is being used (as shown in dining position).

The double dinette easily converts to a double bed. To prepare the bed, take the following steps:

- Fold table leaves and push in supports.
- Slightly raise the aisle end of the table and

depress folding leg lock and fold attached leg under all the way.

- Continue to raise the table end until it becomes disengaged from the wall.
- Place table on floor between dinette seats.

NOTE: There are two handles located under seat cushion, one at each side of seat. Use of one handle should be sufficient when converting



Double Dinette (Dining Position)

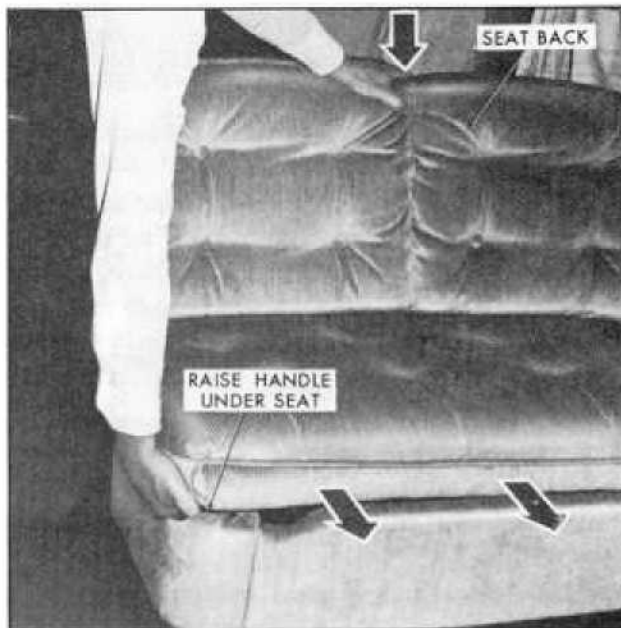

Double Dinette (Converting to Sleeping Position)

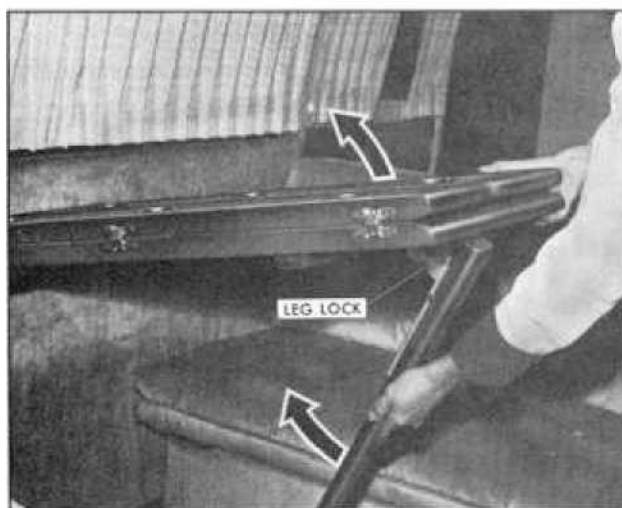

Dinette Table (Disengaging Leg)



Double Dinette (Sleeping Position)



Front Davo

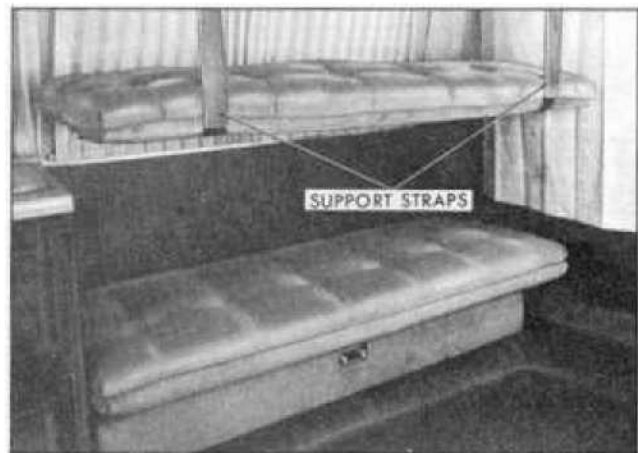

Front Davo (Converted to Bunk Beds)

double dinette from sitting position to sleeping position and when converting double dinette from sleeping position to sitting position.

- Raise handle, located under seat cushion at aisle side of seat, and push seat back downward (as shown) and seat will slide into sleeping position. Repeat procedure on the opposite side.

FRONT DAVO

The front davo converts into two bunk beds, To prepare the davo for sleeping, take the following steps:

- Swing the back support out from the wall.
- Unfold the additional section on the back support to bring it to full width.
- The two support straps can now be hooked to the eyes provided in the ceiling.

SWIVEL CHAIRS

If the MotorHome is equipped with the swivel chairs in the living area, they are operated in the same manner as the seats in the driver's compartment.

CAUTION

Check that all swiveling seats are locked in position before driving off. If any seat swiveled during an accident the occupant may be more likely injured.

SIDE FACING SETTEE

The rear side facing settee is adjustable and provides a normal sitting position, two intermediate sitting positions and a sleeping position. The rear side facing settee converts into a double bed for sleeping. To convert the side facing settee for sleeping perform the following:

- Raise forward edge of seat cushion, and push seat back downward (as shown) and seat will slide into sleeping position. Repeat procedure on the opposite side.
- To convert rear side facing settee back to seating position, grasp forward edge of seat cushion, and raise seat back upward and seat will slide into sitting position. Repeat procedure on the opposite side.



Side Facing Settee

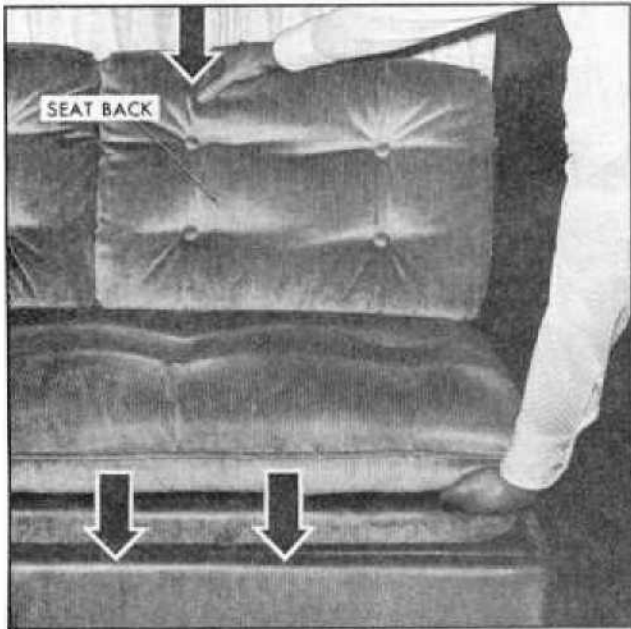

Preparing Settee for Sleeping

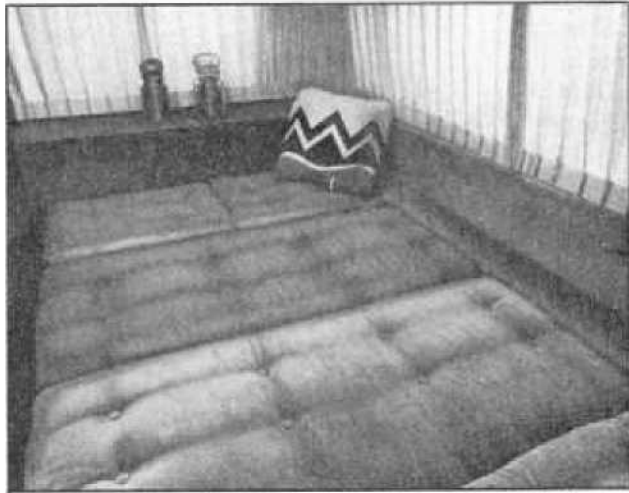

Settee in Sleeping Position

For continuing satisfaction keep your vehicle all GM. General Motors Parts are identified by one of these trademarks:



IN CASE OF EMERGENCY

FOUR-WAY HAZARD WARNING FLASHER

- Use the warning flasher to warn other drivers any time your vehicle becomes a traffic hazard, day or night.
- Avoid stopping on the roadway, if possible.
- Turn on the hazard warning flasher by pushing in on the button located on the column just below the steering wheel. Flasher can be actuated with engine ignition either off or on.
- Turn signals do not work with hazard flashers operating.
- If the brake pedal is depressed, the lights will not flash but remain continuously lit.
- To cancel the flasher, pull the button out.

EMERGENCY STARTING

- Engine cannot be started by towing or pushing the vehicle.
- If only main (automotive) battery is discharged, hold battery switch on instrument panel momentarily in "BAT BOOST." This supplies current from the auxiliary (living area) battery. After use switch is designed to return to the "BAT NORMAL" position.
- A vehicle with both batteries discharged may be started by using energy from a battery in another vehicle—called "Jump Starting."

JUMP STARTING

Jump starting may be dangerous and should be attempted **ONLY** if the following two conditions are met. If they are not, we strongly recommend that you leave the starting to a competent mechanic.

- The battery in the other vehicle must be 12-VOLT and **NEGATIVELY GROUNDED**, like the batteries in your vehicle. (Check the other vehicle's owner's manual to see if it is.)
- The batteries in your vehicle must be equipped with **FLAME ARRESTOR TYPE FILLER/VENT CAPS** on **ALL** filler openings (as was your original-equipment Delco

batteries), or it must be a sealed-type battery which does not have filler openings or caps. (Each Delco battery flame arrestor cap has a grey disc rather than a small hole—see illustration.)



Hazard Warning Flasher

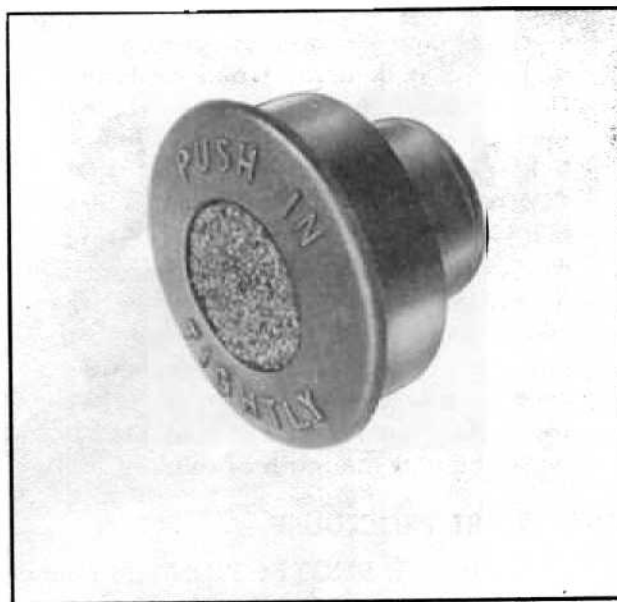

Flame Arrestor Cap

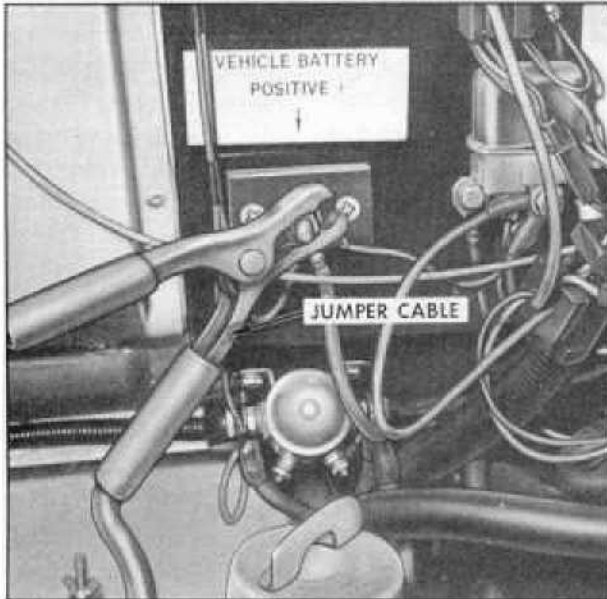

*Connecting Jumper Cable to
"VEHICLE BATTERY POSITIVE" Stud*

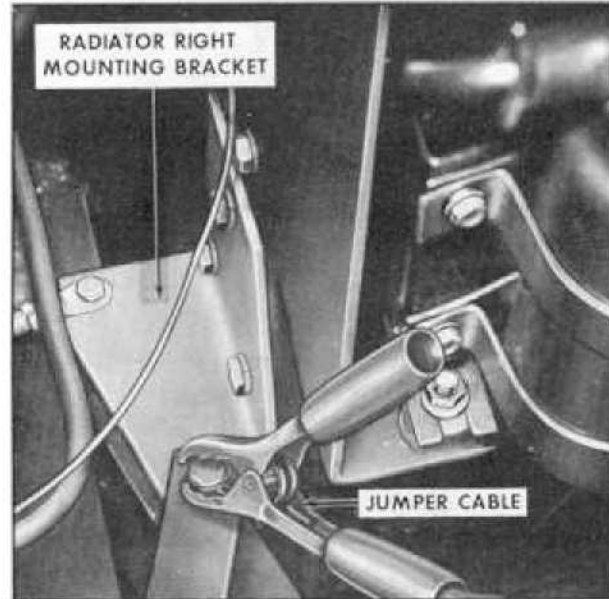

*Connecting Jumper Cable to
Right Radiator Mounting Bracket*

CAUTION

Departures from these conditions or the procedure below could result in: (1) serious personal injury (particularly to eyes) or property damage from such causes as battery explosion, battery acid, or electrical burns; and/or (2) damage to electronic components of either vehicle.

Never expose battery to open flame or electrical spark—batteries generate a gas which is flammable and explosive. Do not allow battery fluid to contact eyes, skin, fabrics, or painted surfaces—fluid is a corrosive acid. **FLUSH ANY CONTACTED AREA WITH WATER IMMEDIATELY AND THOROUGHLY.** Be careful that metal tools, or jumper cables do not contact the positive battery terminal (or metal in contact with it) and any other metal in the other vehicle, because a short circuit could occur. Batteries and battery acid should always be kept out of the reach of children.

JUMP START PROCEDURE

1. WEAR EYE PROTECTION and remove rings, metal watch bands, and other metal jewelry.
2. Set parking brake firmly, and place auto-

matic transmission in "PARK" in both vehicles (don't let vehicles touch); and turn ignition key to LOCK in vehicle with discharged battery (Neutral and "OFF" in vehicles with manual transmission). Also turn off lights, heater, and all unnecessary electrical loads.

3. Attach one end of a jumper cable to the positive terminal (identified by a red color, "+", or "P" on the battery case, post, or clamp), of the battery in the other vehicle and the other end of the same cable to positive terminal junction block stud, marked "VEHICLE BATTERY POSITIVE." This is located behind the right access door above the main (automotive) battery.

4. Attach one end of the remaining jumper cable **FIRST** to the negative terminal (black color, "-", or "N") of the **OTHER** vehicle's battery, (regardless of which vehicle has the discharged battery) and **THEN** to the right radiator mounting bracket in **THIS** vehicle—thus taking advantage of your battery's flame arrestor feature, should a spark occur.

5. Start the engine in the vehicle that is providing the jump start (if it was not running). Let run a few minutes, then start the engine in the vehicle that has the discharged battery.

6. Reverse the above sequence **EXACTLY** when removing the jumper cables, taking care to remove the cable from the right radiator mounting bracket in **THIS** vehicle as the **FIRST** step.

ENGINE COOLANT CAUTION

- To avoid the danger of being burned, do not remove radiator cap while engine and radiator are still hot, because the cooling system will blow out scalding fluid and steam under pressure.
- Do not remove radiator cap to check engine coolant level; check coolant visually at the see-through coolant tank.
- Proper coolant level at normal engine operating temperature is between the "FULL" and "ADD" marks on the tank.
- Coolant should be added only to the reservoir (see SERVICE & MAINTENANCE section for details).

JACK USAGE INSTRUCTIONS

CAUTIONS

1. Follow jacking instructions in order to reduce the possibility of serious personal injury.
2. The jack is designed for use only when changing wheels.
3. Never get beneath the vehicle when using jack.
4. Do not start or run engine while vehicle is on jack.

INSTRUCTIONS

- Park level surface and set parking brake firmly
- Set transmission in "PARK"
- Activate Hazard Warning Flasher
- Block front and rear of the vehicle diagonally opposite the jack position.
- Loosen but do not remove wheel nuts
- JACKING AT FRONT – Place hydraulic jack on wood block near energy absorbing front bumper bracket. Place hook at flange of front cross-member. Pass chain under bumper and adjust chain length to snug fit on fork on top of jack.

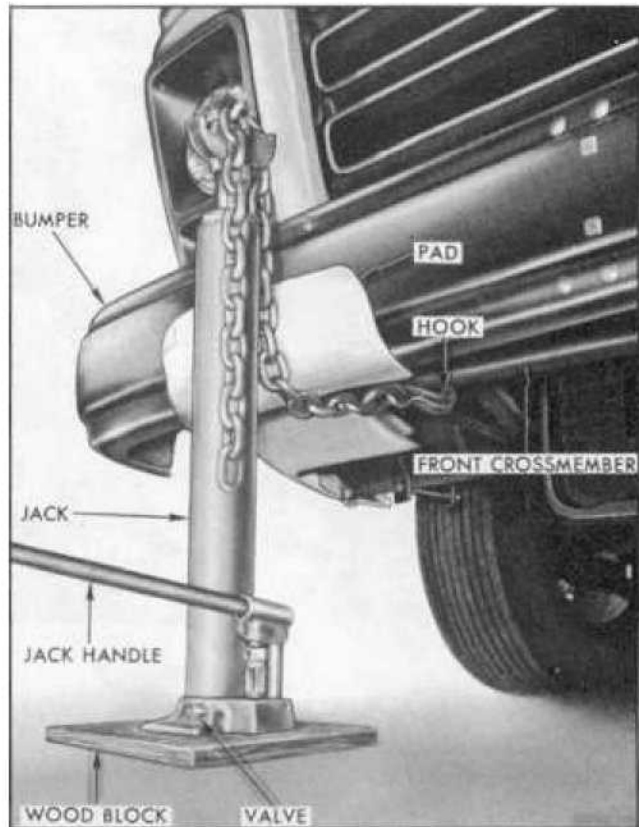

Jacking at Front of Vehicle

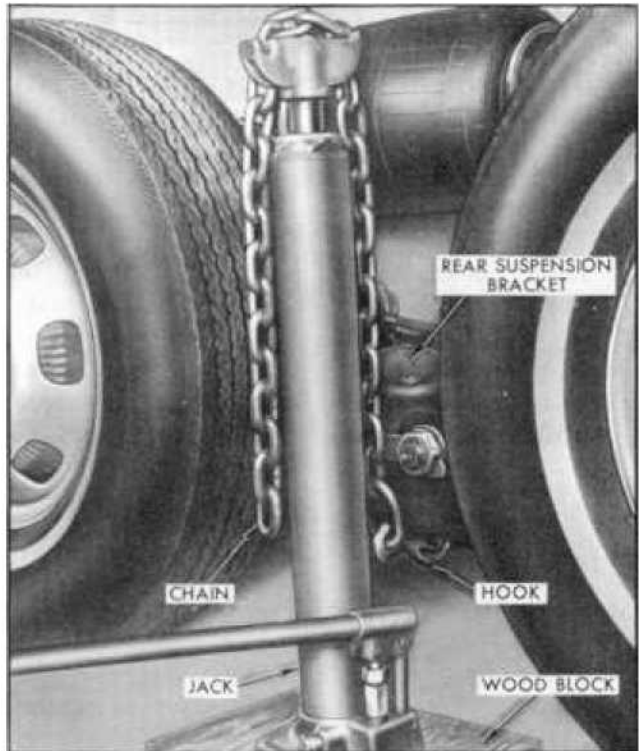

Jacking at Rear of Vehicle

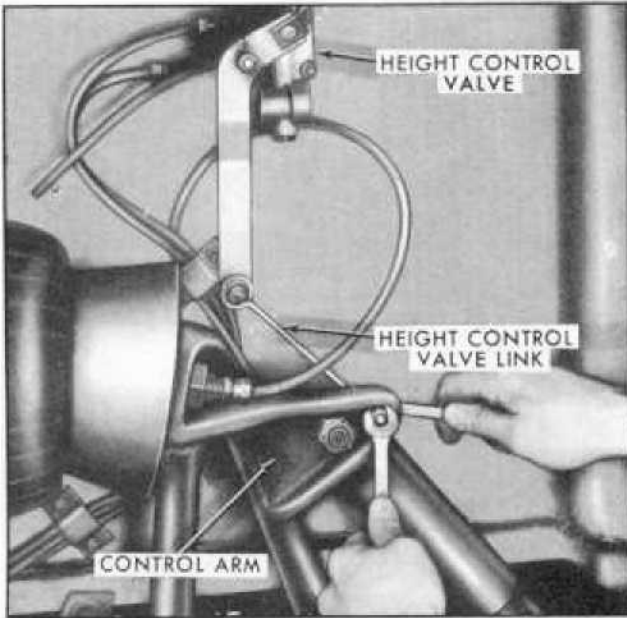

Disconnecting Height Control Valve Link

- **JACKING AT REAR**—Remove fender skirt. Place hydraulic jack on wood block close to rear suspension bracket (see next page). The hook is placed in the drainage slot under bracket. Adjust chain length so link will fit in fork at top of jack.
- Close valve at base of jack and insert jack handle.
- Always operate jack with slow, smooth motion.
- Raise vehicle so tire just clears surface, replace wheel and slightly tighten wheel nuts.
- Open valve at base of jack to lower, then fully tighten wheel nuts. Proper torque is 250 foot pounds.

CAUTION

Use lug wrench provided to tighten wheel nuts securely. (Follow the nut tightening sequence shown in the **SERVICE AND MAINTENANCE** section.) At the earliest opportunity have wheel nut torque checked. This is necessary to help prevent loosening or stripping of the wheel nuts.

TOWING

Proper lifting and towing equipment is necessary to prevent damage to the vehicle during any towing operation. State (Provincial in Canada) and local laws applicable to vehicles to tow must be followed. Detailed towing instructions are available at your MotorHome dealer.

Your vehicle may be towed on all six wheels, at speeds less than 35 MPH, for distances up to 50 miles, provided the final drive, axle, transmission, and steering system are otherwise normally operable. Use only towing equipment specifically designed for this purpose following the instructions of the towing equipment manufacturer. A separate safety chain system must be used. For such towing the steering must be unlocked, transmission in neutral and the parking brake released. Attachments must be to engine front crossmember. Do not attach to bumpers or associated brackets. Remember that power brakes and power steering assists will not be available when engine is inoperative.

TOWING AT FRONT

On vehicles equipped with the Power Level System, turn the valve dials, below the instrument panel, to "HOLD" position, thereby making the automatic height valves inoperative on the rear suspension. On vehicles not equipped with the optional Power Level System it will be necessary to disconnect the height control valve link at the rear suspension control arm (adjacent to the shock absorber stud) on each side of the vehicle. Raising front of vehicle so front wheels are four inches off the ground will provide about five-inch ground clearance at the rear when towing.

TOWING AT REAR

It is not recommended that vehicle be towed with the rear raised as this could result in suspension or crossmember damage.

FREEING VEHICLE FROM SAND, ETC.

If it becomes necessary to rock the Motor Home to free it from sand, mud, or snow, move the transmission selector lever from "D" to "R" in a repeat pattern while simultaneously applying moderate pressure to the accelerator. Do not race engine. For best possible traction, avoid spinning wheels when trying to free the vehicle.

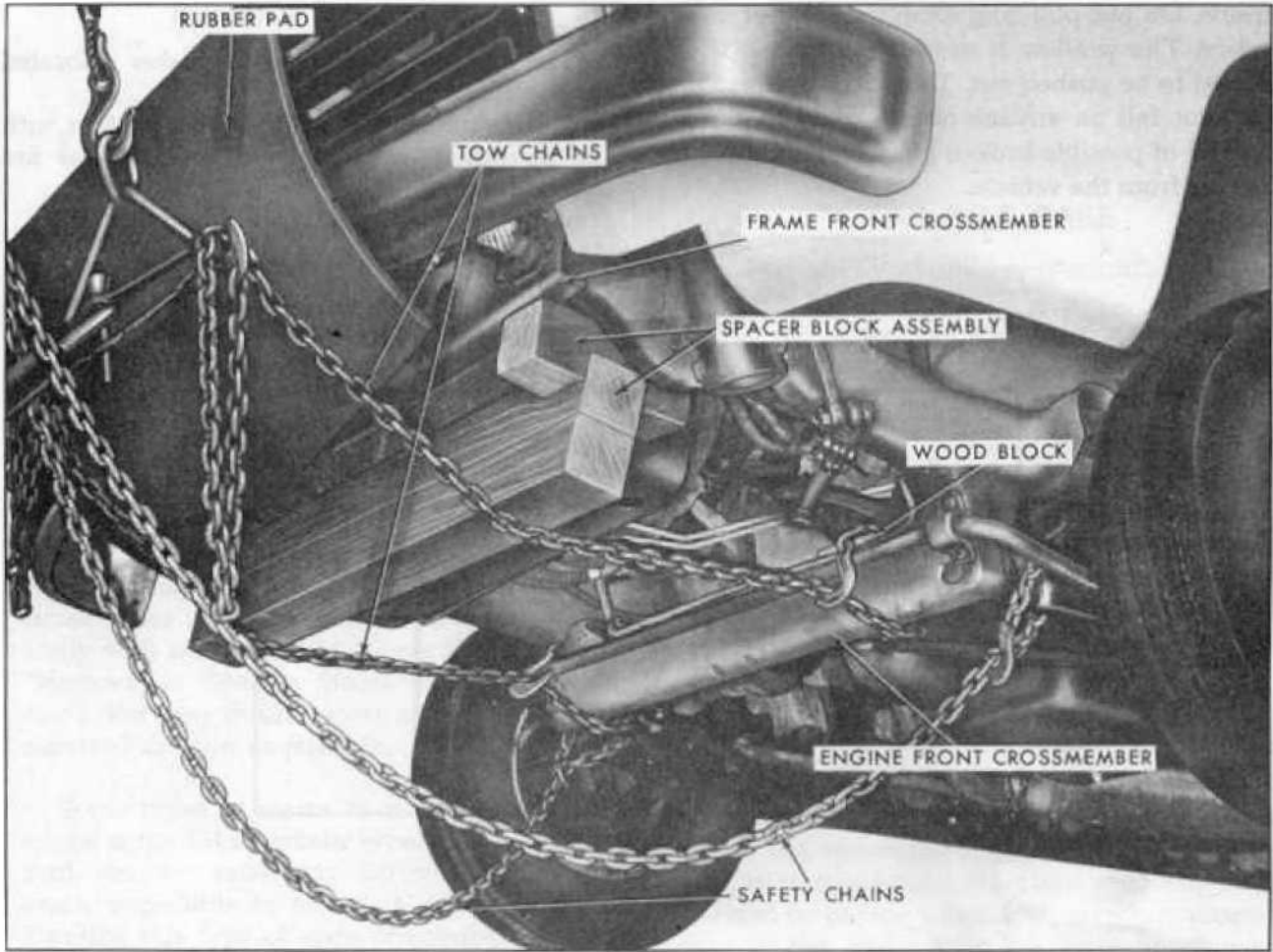

Towing Vehicle

The use of GM Liquid Tire Chain is recommended for temporary assistance when traction is lost on ice or snow.

CAUTION

Do not spin wheels in excess of 35 MPH as indicated on the speedometer. Personal injury and severe damage may result from excessive wheel spinning including tire disintegration or differential failure.

EMERGENCY EXIT

The rear window of the vehicle in an emergency can be used as an exit. To use the emergency exit, pull the ring located at the top center of the rear window until window seal is removed, and then push the glass out of the

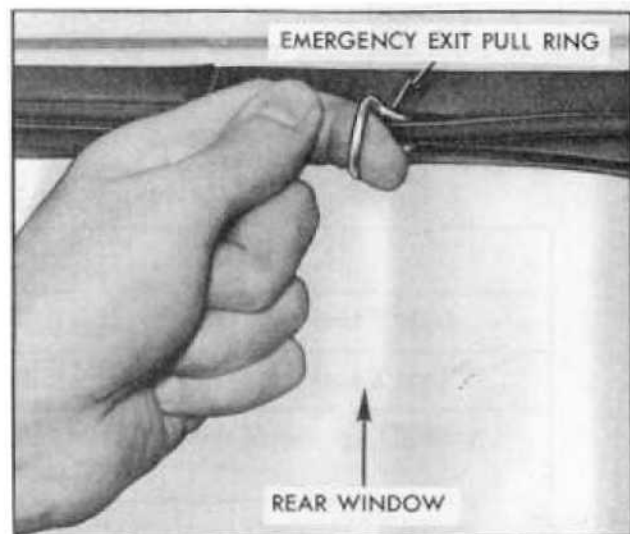

Emergency Exit Pull Ring

frame. Do not pull ring except in case of emergency. The window is not hinged, and it is designed to be pushed out. Take care that window will not fall on anyone outside the vehicle. Be careful of possible broken glass on ground when exiting from the vehicle.

FIRE EXTINGUISHER

The dry chemical, fire extinguisher is located in the vehicle closet.

It is recommended that you be familiar with the operating instructions located on the fire extinguisher.

For continuing satisfaction keep your vehicle all GM. General Motors Parts are identified by one of these trademarks:



APPEARANCE CARE

CARE AND CLEANING OF INTERIOR

GENERAL INFORMATION

Dust and loose dirt that accumulates on interior fabric trim should be removed frequently with a vacuum cleaner, whisk broom or soft brush. Vinyl or leather trim should be wiped regularly with a clean damp cloth. Normal trim soilage, spots or stains can be cleaned with GM cleaners or equivalent.

Before attempting to remove spots or stains from upholstery, determine as accurately as possible the nature and age of the spot or stain. Some spots or stains can be removed satisfactorily with water or mild soap solution (refer to "Removal of Specific Stains" later in this section). For best results, spots or stains should be removed as soon as possible.

Some types of stains or soilage such as lipsticks, some inks, certain types of grease, mustard, etc., are extremely difficult and, in some cases, impossible to completely remove. When cleaning this type of stain or soilage, care must be taken not to enlarge the soiled area. It is sometimes more desirable to have a small stain than an enlarged stain as a result of attempted cleaning.

The listed cleaners are **EXCELLENT CLEANERS** when used properly according to directions on containers and are available through most G.M. Dealerships.

LAP BELT CARE

- Clean only with mild soap solution and lukewarm water.
- Do not bleach or dye belts since this may severely weaken belts.

INTERIOR GLASS

The interior glass surface should be cleaned on a periodic basis for continued good visibility. A commercial household glass cleaning agent containing ammonia will remove normal tobacco smoke and dust films sometimes caused by ingredients used in vinyls, plastics, or other interior trim materials.

KITCHEN SINK

The stainless steel sink should be cleaned with a liquid or finely ground powder. Scouring powder is not recommended for stainless steel and will ruin the finish. Stainless steel cannot be harmed by boiling water. However, salt, mustard, mayonnaise and catsup will cause pitting and should be cleaned off immediately.

VACUUM CLEANER

The MotorHome integral vacuum cleaner (if equipped) operates on 120-volt current. The vehicle must be connected to an external power source or the motor generator must be in operation in order to operate the vacuum cleaner.

G.M. CLEANERS

PART NO.	QUANTITY	DESCRIPTION
1050244	16 oz. can	G.M. Fabric Cleaner (Solvent Type)
1050417	Gallon can	G.M. Fabric Cleaner (Solvent Type)
1050803	16 oz. Container	G.M. Multi-Purpose Powdered Cleaner (Foam Type)
1050429	6 lb. can	G.M. Multi-Purpose Powdered Cleaner (Foam Type)

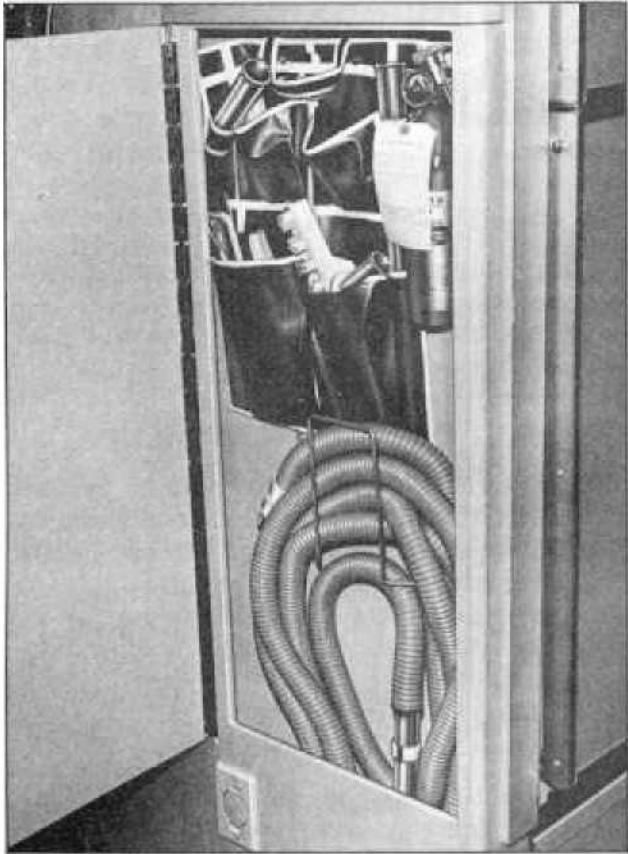

Vacuum Cleaner Components

Vacuum cleaner components are stored in the side of the refrigerator module near the entrance door. The vacuum cleaner storage cabinet contains a long flex hose, wand, and a wide assortment of wand attachments including one for shag carpeting.

To operate the vacuum system, remove flex hose from the cabinet, lift vacuum inlet hinge cap, just under the storage cabinet, and insert the proper end of the flex hose. At this point the vacuum system will be operating and is used in the same manner as any household vacuum cleaner.

DRAPERY CARE

The draperies used in the GMC MotorHome are to be **DRY CLEANED ONLY**.

CLEANING FABRICS

IMPORTANT: Be sure vehicle is well ventilated while using cleaning agents. Follow manufacturer's recommendations in using such products.

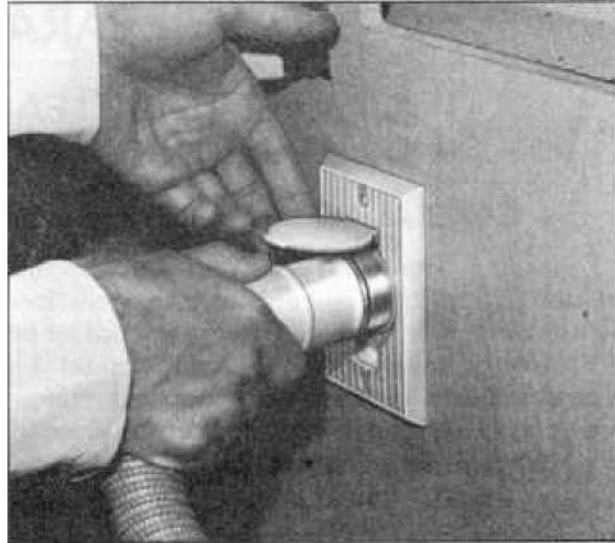

Connecting Flex Hose to Wall Socket

CAUTION

Many cleaners may be toxic or flammable, and their improper use may cause personal injury or may cause damage to the interior. Therefore, when cleaning the interior, do not use volatile cleaning solvents such as: acetone, lacquer thinners, enamel reducers, nail polish removers; or such cleaning materials as laundry soaps, bleaches or reducing agents (except as noted in the adjacent fabric cleaning instructions on stain removal). Never use carbon tetrachloride, gasoline or naphtha for any cleaning purpose.

CLEANING FABRICS WITH CLEANING FLUIDS

G.M. Fabric Cleaner (Solvent Type) is excellent for spot cleaning stains containing grease, oil or fats from fabric type trim. Excess stain should be gently scraped off trim material with a clean DULL knife or scraper. **USE VERY LITTLE CLEANER**, light pressure, and clean cloths (preferably cheese cloth). Cleaning action should be from outside of stain **FEATHERING** towards center of stain and constantly changing to a clean section of cloth. When stain is cleaned from fabric, immediately dry area with an air hose, heat dryer or heat lamp to help prevent a cleaning ring (use caution with heat dryer or heat lamp to prevent damage to fabric material). If a ring forms, immediately

repeat the cleaning operation over a slightly larger area with special emphasis on FEATHERING towards center of area. If ring still persists, mark off adjacent trim sections and clean entire affected trim panel section with G.M. Multi-Purpose Powdered Cleaner as described in the following.

CLEANING FABRICS WITH DETERGENT FOAM CLEANER

G.M. Multi-Purpose Powdered Cleaner is excellent for this type cleaning and for cleaning a panel section where a minor cleaning ring may be left from spot cleaning.

Vacuum area thoroughly to remove excess loose dirt. ALWAYS clean a full trim assembly or complete trim section—mask adjacent trim along stitch or welt lines. Mix Multi-Purpose Powdered Cleaner in strict accordance with directions on label of container—mix proportionally for smaller quantities. USE SUDS ONLY ON A CLEAN SPONGE or SOFT BRISTLE BRUSH—DO NOT WET FABRIC EXCESSIVELY OR RUB HARSHLY WITH BRUSH. IMMEDIATELY AFTER CLEANING WIPE OFF ANY CLEANER RESIDUE WITH SLIGHTLY DAMP ABSORBENT TOWEL OR CLOTH.

IMPORTANT — IMMEDIATELY AFTER WIPING, FORCE-DRY FABRIC WITH AIR HOSE, HEAT DRYER OR HEAT LAMP. (Use caution with heat dryer or heat lamp to prevent damage to fabric.)

When trim materials with a sheen or luster finish are dry, wipe fabric lightly with a soft, dry clean cloth to restore sheen or luster.

REMOVAL OF SPECIFIC STAINS

CANDY—Chocolate, use cloth soaked in lukewarm water; other than chocolate, use very hot water. Dry if necessary, clean lightly with fabric cleaning fluid.

CHEWING GUM—Harden gum with ice cube and scrape off with dull knife. Moisten with fabric cleaning fluid and scrape again.

FRUIT STAINS, COFFEE, LIQUOR, WINE, SOFT DRINKS, ICE CREAM AND MILK—Wipe with cloth soaked in cold water. If necessary, clean lightly with fabric cleaning fluid. Soap and water is not recommended as it might set the stain.

CATSUP—Wipe with cloth soaked in cool water. If further cleaning is necessary, use a detergent foam cleaner.

GREASE, OIL, BUTTER, MARGARINE AND CRAYON—Scrape off excess with dull knife. Use fabric cleaning fluid.

PASTE OR WAX TYPE SHOE POLISH—Light application of fabric cleaning fluid.

TAR—Remove excess with dull knife, moisten with fabric cleaning fluid, scrape again, rub lightly with additional cleaner.

BALL POINT INK—Try rubbing alcohol. If stain remains after repeated operations, no other measure should be tried.

LIPSTICK—Difficult to remove. Cleaning fluid works on some brands. If stain remains after repeated applications, do not try other measures.

MUSTARD—Damp sponge with warm water, then rub detergent on dampened stain and work into fabric. Rinse with clean damp cloth. Repeat several times. Some discoloration may remain.

BLOOD—Wipe with clean cloth moistened with cold water. Use no soap.

URINE—Sponge stain with lukewarm soap suds from mild neutral soap on clean cloth, rinse with cloth soaked in cold water; saturate cloth with one part household ammonia and five parts water, apply for one minute, rinse with clean, wet cloth.

VOMITUS—Sponge with clean cloth dipped in clean, cold water. Wash lightly with lukewarm water and mild neutral soap. If odor persists, treat area with a water-baking soda solution (one teaspoon baking soda to one cup of warm water). Rub again with cloth and cold water. Finally, if necessary, clean lightly with fabric cleaning fluid.

EXTERIOR APPEARANCE CARE

The best way to preserve the finish is to keep it clean. Normally only frequent washings are required to maintain its original beauty. Wash the vehicle with either cold or warm (never hot) water, not in the direct rays of the sun and not while the sheet metal surfaces are hot. Never wipe dirt from dry painted surfaces because this may scratch the finish. The use of strong soaps and chemical detergents should be avoided. Cleaning agents should be promptly flushed from the surface and not allowed to dry or they may streak the finish.

BRIGHT METAL PARTS

Wash all bright metal parts frequently to alleviate the destructive forces of salt, calcium chloride, salt air, exhaust gases, and industrial fallout (which may be corrosive).

Use lukewarm water and mild soap, not with a strong alkali solution, rinse thoroughly. Avoid use of bright metal polishes containing harmful abrasives.

NOTE: In severe cases, road oil and tar may be removed from bright metal parts by a chemical cleaner which is specified safe to use on all acrylic finishes.

A protective coating such as GM Chrome Gard may be applied on clean chrome surfaces which are stain and rust free. If necessary, GM Chrome Cleaner and Polish may be used to remove rust from chrome plated parts before applying a protective coating.

EXTERIOR GLASS

Never wipe glass with dry paper or cloth. Do not operate wipers when glass is dry. Dirt and insects can be removed with clear water or with a mild liquid household cleaner. The use of harsh abrasives should be avoided. Periodic inspection and replacement of wiper blades will reduce the possibility of the windshield becoming scratched and will assure clear vision under adverse driving conditions.

POLISHING AND WAXING

Even though the acrylic enamel on your vehicle is durable, under certain conditions it may be advisable to wax or polish your vehicle to provide added protection. Calcium chloride and other salts, road oil and tar, tree sap, chemicals from factory chimneys and other foreign matter may damage any known vehicle finish if allowed to remain in contact with the paint film.

Prompt washing may not remove thoroughly these deposits and, particularly in geographical areas where exposure conditions are severe. Properly applied polishes and waxes of known quality will provide the best protection. Most GMC MotorHome dealers offer polishes or waxes which can be of real value in maintaining a good paint finish.

NOTE: Some chemical cleaners, used for removing road oil and tars from painted surfaces, are detrimental to acrylic enamel finishes. When purchasing a cleaner, make sure the instructions on the container specifically state that the contents can be used on any acrylic enamel finish.

TOUCH-UP PAINT

Nicks and chips in paint surfaces should be touched up before weathering action begins. The best time to detect them is right after the vehicle has been washed. Touch-Up Paint to match your vehicle's color is available at your GMC MotorHome dealer.

UNDERCOATING

Due to the fiberglass and aluminum body construction of the vehicle added protection by additional undercoating is not necessary. However, if you do wish to apply undercoating material, it should be kept off of all moving or rotating parts. It should also be kept off air conditioner fittings, body drain holes, exhaust systems, and plumbing.

SERVICE AND MAINTENANCE

CAUTION

As with any machinery, extreme care should be taken when performing any inspection, maintenance or repairs so as to prevent accidental injury. Improper or incomplete servicing could result in vehicle operational problems which may lead to personal injury, or damage to the vehicle or its equipment. Should you have any question about performing any service, have the service performed by a competent serviceman.

MAINTENANCE SCHEDULE

For owner convenience, a separate maintenance folder has been provided with your vehicle which contains a complete schedule and brief

explanation of the safety, emission control, lubrication and general maintenance it requires. The maintenance folder information is supplemented

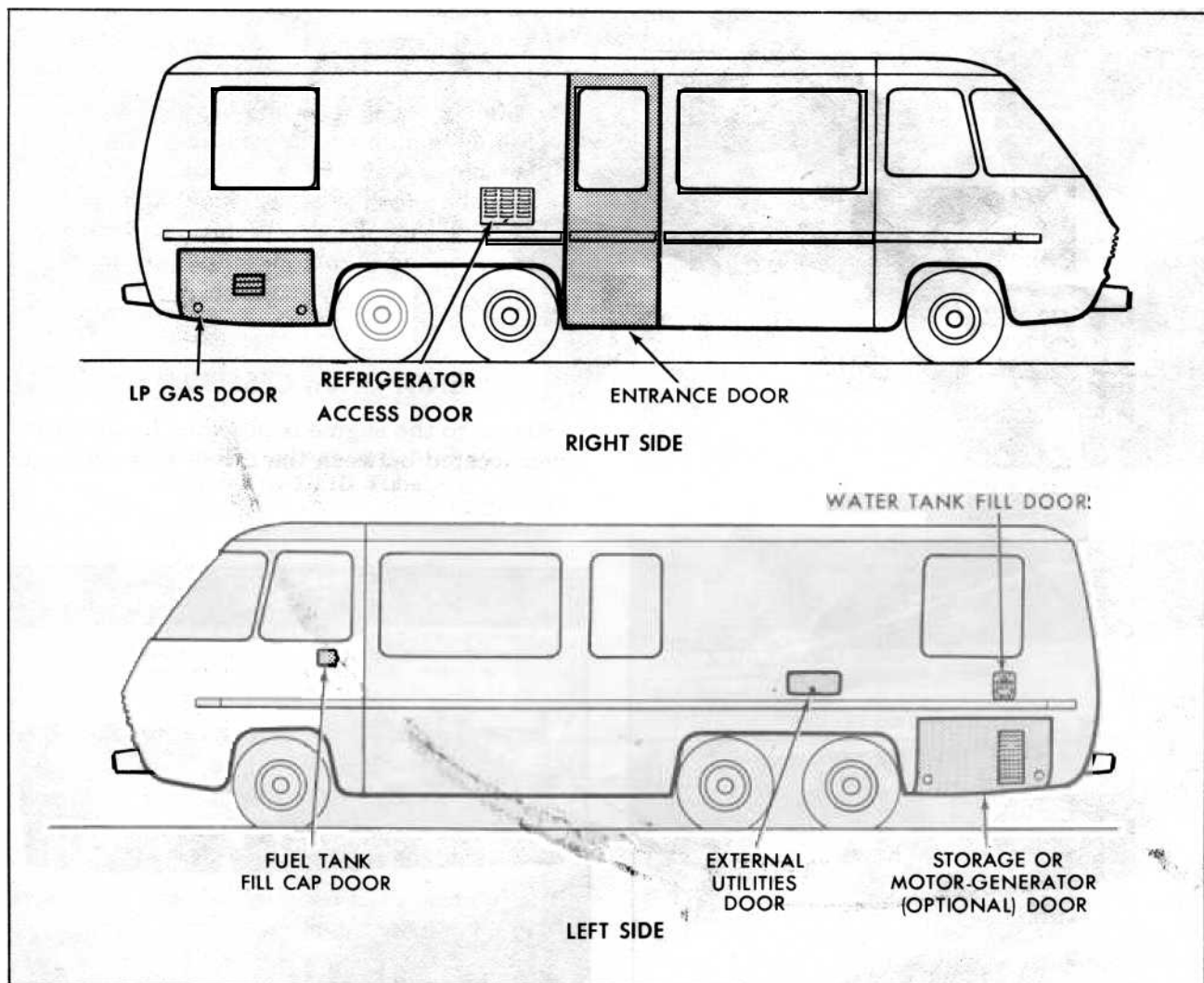

Exterior Compartment Location (Typical)

by this section of the Operating Manual, as well as the separate emission control systems folder also furnished with your vehicle. Read all three

publications for a full understanding of vehicle maintenance requirements.

ACCESSIBILITY

EXTERIOR COMPARTMENTS

Your vehicle has an entrance door on the right side and seven compartment doors. Their locations are shown on the following illustrations.

Be sure the doors are secured tightly to prevent their opening after vehicle is in motion.

There are two front access doors on your vehicle. Turn the latch knob to the left to release each door. Items that can be checked or filled through the right access door are the main

(automotive) battery, engine oil fill, radiator, radiator cap, coolant recovery tank and the air conditioner receiver-dehydrator sight glass (optional). Items that can be checked or filled through the left access door are the windshield washer reservoir, brake master cylinder, engine oil dipstick and the air compressor.

Be sure to secure the access doors after closing them by turning the latch knob to the right to prevent the doors from opening after the vehicle is in motion.



Front Access Doors

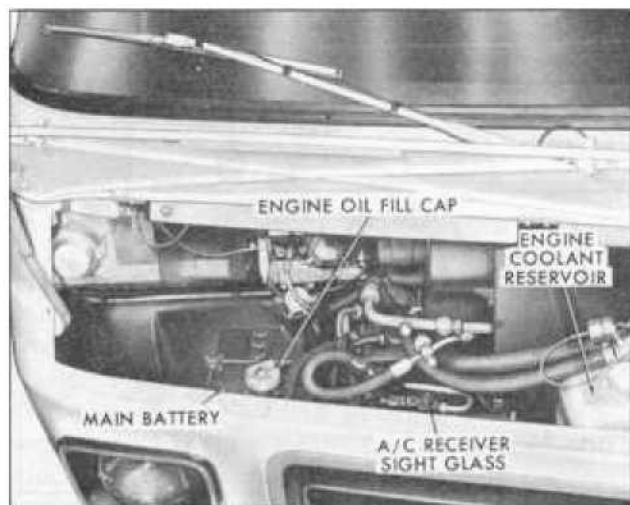

Right Front Access Compartment

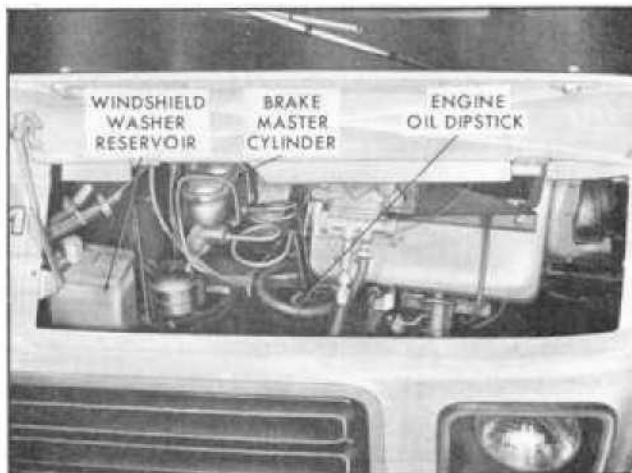

Left Front Access Compartment

CAUTION

Before pouring fluid into any filler opening anywhere on the vehicle, or allowing anyone else to do so, make certain that the correct filler opening, and type of fluid has been selected. A wrong choice could result in serious personal injury or property damage.

ENGINE ACCESSIBILITY

Access to the engine is provided by an engine cover located between the driver and passenger

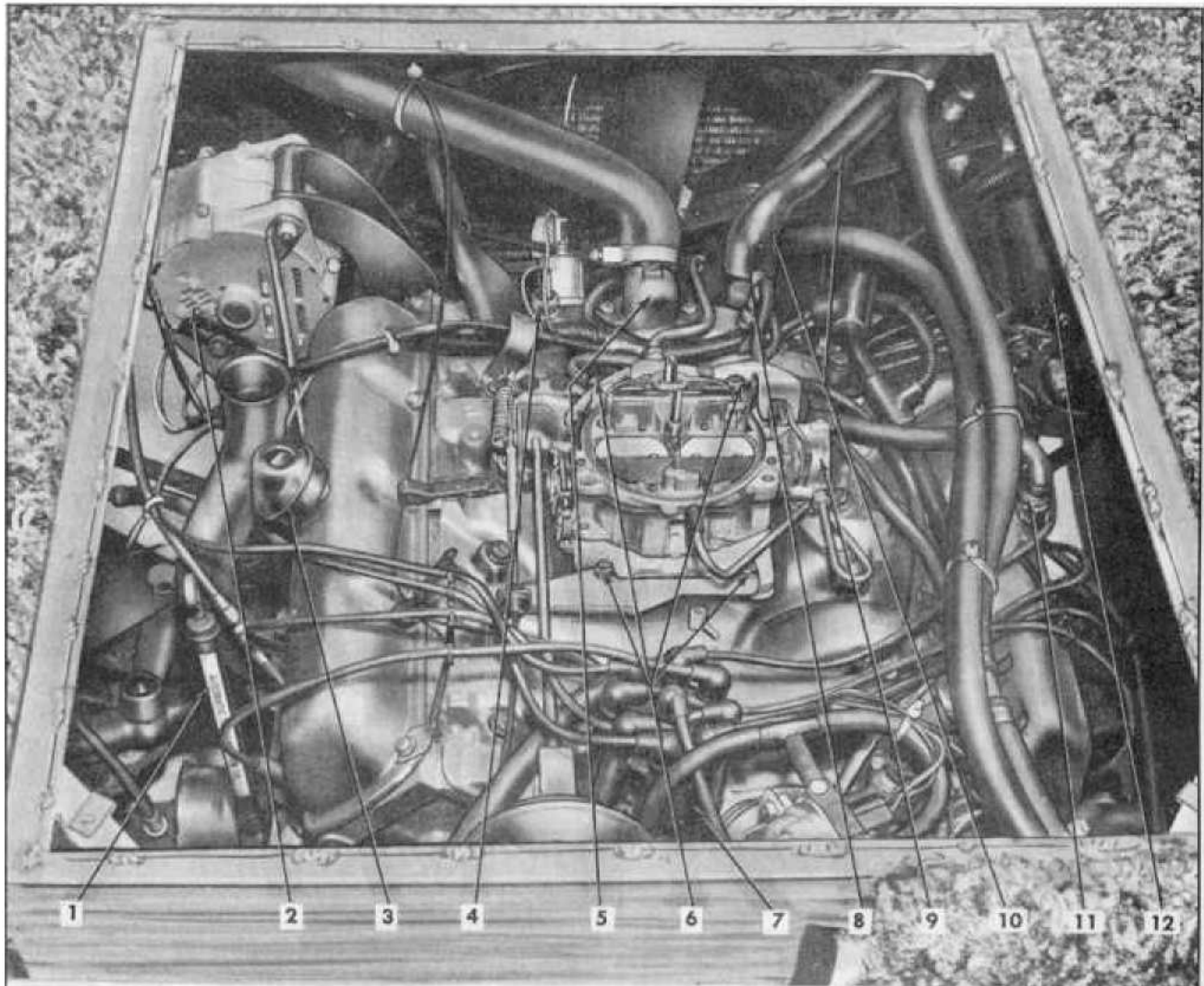

- 1 Automatic Transmission Fluid Dipstick and Fill Tube
- 2 Generator
- 3 PCV Filter
- 4 Engine Temperature Sending Unit
- 5 Thermostat Housing
- 6 Carburetor Attaching Bolts (4)

- 7 Distributor
- 8 Thermal Vacuum Switch
- 9 Carburetor Choke Coil Cover
- 10 Engine Oil Fill Hose and Tube Assembly
- 11 PCV Valve
- 12 Air Conditioning Compressor (Optional)

Engine Compartment

seats. The cover is designed to be secured at the two rear corners by securing bolts. The securing bolts have rings and may be loosened or tightened by hand or screwdriver. The cover is designed to be secured at the front by a retaining lip.

To remove the engine cover loosen the securing bolts and lift up using the wire loops. To install the engine cover place the cover in its frame and slide forward as far as possible. Tighten the securing bolts.

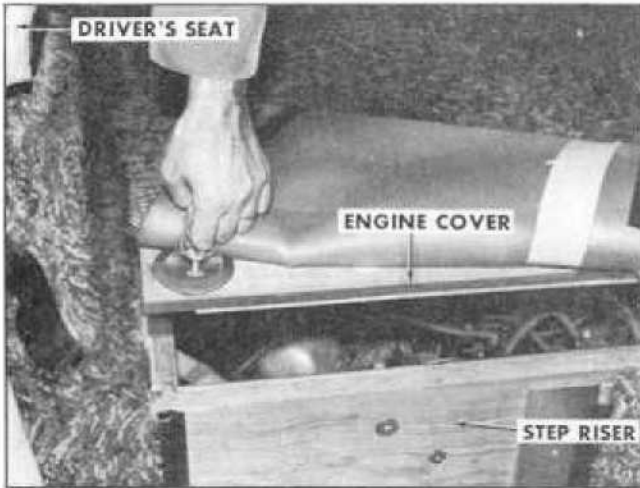

Removing Engine Access Cover

edge and the securing bolts at its rearward edge. Do NOT allow cables, carpeting, floor mats or any other material to interrupt the seat between the cover and the engine compartment. If the engine cover is not correctly installed and seated, engine exhaust could leak into the passenger compartment creating a safety hazard (see the carbon monoxide caution at the beginning of the section on **STARTING AND OPERATING VEHICLE**). If the engine must run with the cover off for maintenance purposes, care should be taken to assure that the vehicle's interior is well ventilated.

CAUTION

It is essential that when installing the engine cover it be fully seated to its seal and secured by the lip at its forward

ENGINE COMPARTMENT LIGHT

The optional engine compartment light (located behind right front access door) is turned ON when access door is opened. The light, attached to a 25-foot cord, may be removed from engine compartment for use as necessary.

HOISTING INSTRUCTIONS

A twin post hoist of sufficient capacity and with proper adapters and/or fittings must be used.

Front hoisting position is the front engine crossmember.

Rear hoisting must be done at the rear suspension brackets. If an "I" beam type adapter is used it should be approximately 82 inches in length to gain adequate support at suspension brackets.

If vehicle is to be placed on safety stands for maintenance or repairs, the hoisting points should be used.

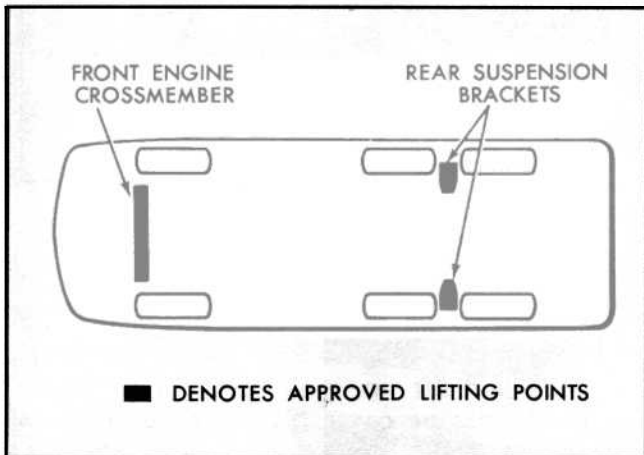

Vehicle Hoisting Points

CAUTION

To help avoid serious damage to your vehicle, the vehicle should be raised only on twin post hoists of 15,000 pounds or more total rated capacity, at the suspension points noted (see diagram). Before raising, check overhead clearance to see that it is sufficient for the vehicle. Do NOT use the vehicle jack for hoisting or maintenance. It is designed for use only when changing tires.

LUBRICATION DETAILS

— ENGINE

ENGINE OIL AND FILTER RECOMMENDATIONS

- Use only SE engine oil.
- Refer to Maintenance Schedule folder for oil change and filter replacement intervals.
- See your GMC MotorHome dealer for advice on the frequency of oil and filter changes under unusual driving conditions.

The recommendations in the Maintenance Schedule folder apply to the first change as well as subsequent oil changes. The oil change interval for your vehicle's engine is based on the use of SE oils and quality oil filters. Oil change intervals longer than those listed will seriously reduce engine life and may effect GMC Truck & Coach's obligation under the provisions of the New Vehicle Warranty.

A high quality SE oil was installed in your engine at the factory. It is not necessary to change this factory-installed oil prior to the recommended normal change period. However, check the oil level more frequently during the break-in period since higher oil consumption is normal until the piston rings become seated.

NOTE: Non-detergent and other low quality oils are specifically not recommended. Only the use of SE engine oils and proper oil and filter change intervals assure you of continued proper lubrication of your vehicle's engine.

RECOMMENDED SAE VISCOSITY

- Single grade oils are preferred, however, multigrades such as SAE 10W-30 or 10W-40 are also acceptable.
- SAE 5W-20 oils are not recommended for sustained high speed driving.
- SAE 5W-30 oils (if available) may be used if extreme low temperatures are anticipated.

SUPPLEMENTAL ENGINE OIL ADDITIVES

The regular use of supplemental additives is specifically not recommended and will increase operating costs. However, supplemental additives are available that can effectively and economically solve certain specific problems without causing other difficulties. For example, if higher detergency is required to reduce varnish and sludge deposits resulting from some unusual operational difficulty, a thoroughly tested and approved additive—"Super Engine Oil Supplement"—is available at your GMC MotorHome dealer. In the event of an operational problem, consult your dealer for advice before using supplemental additives.

CHECKING OIL LEVEL

The engine oil should be maintained at the proper level. The best time to check it is before operating the engine or as the last step in a fuel stop. This will allow the normal oil accumulation in the engine to drain back into the crankcase.

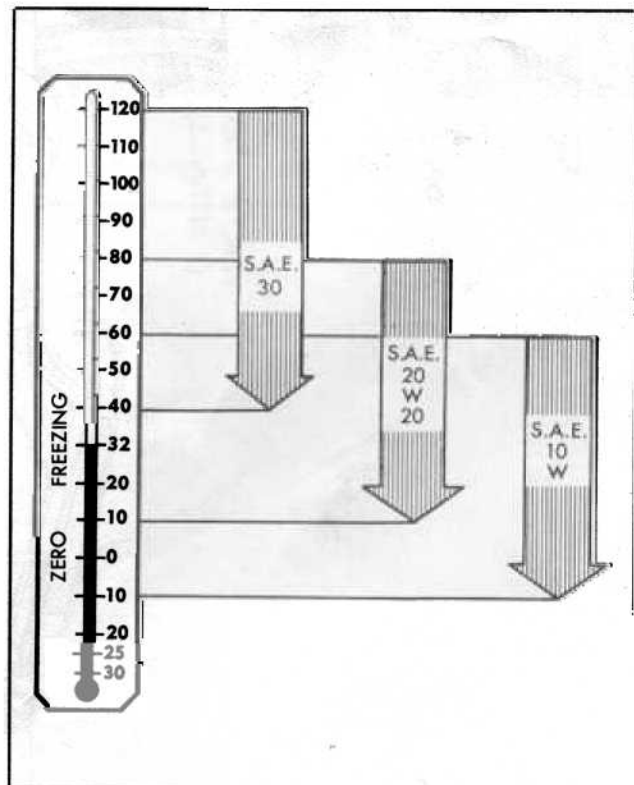

Engine Oil Viscosity Chart

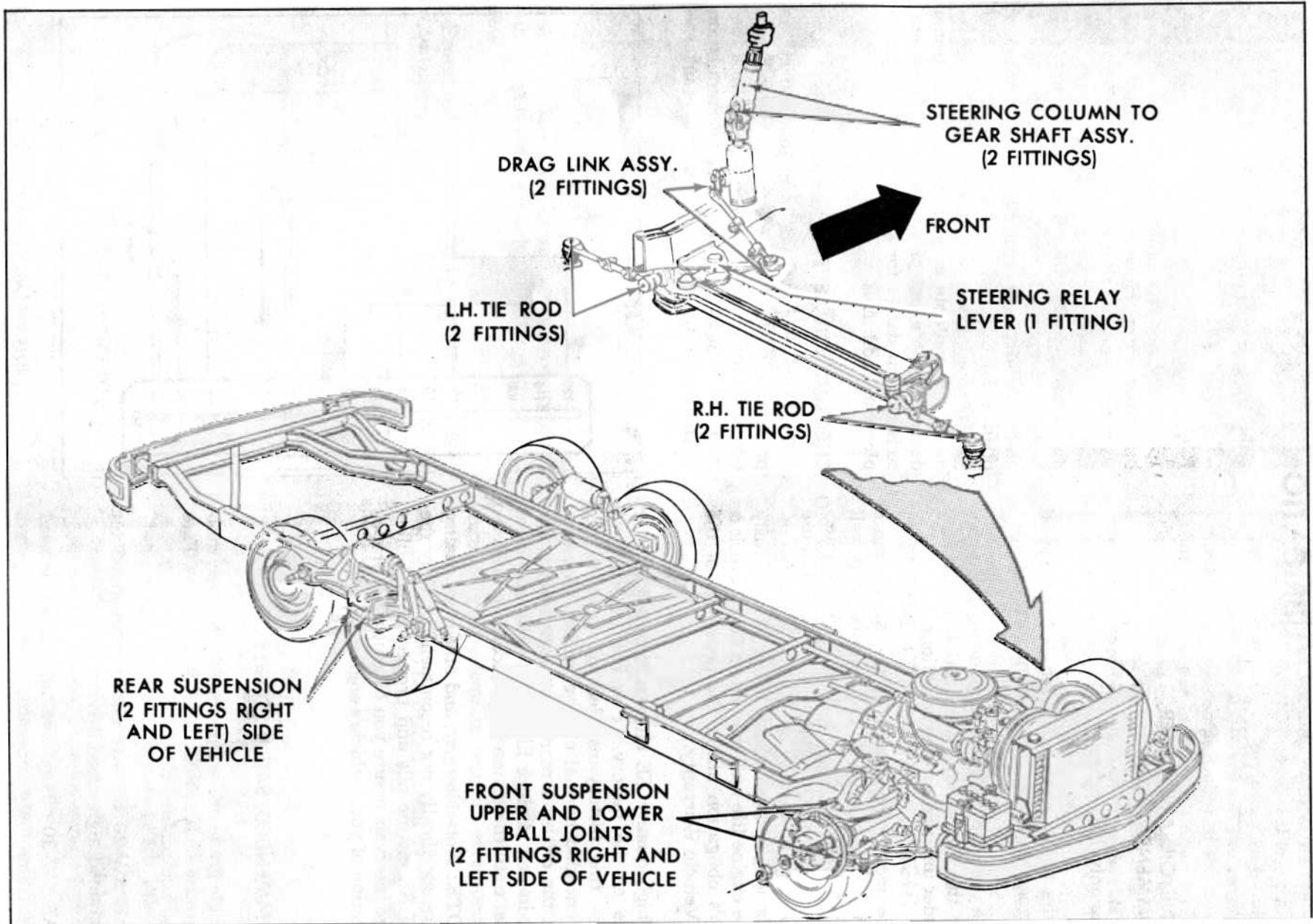

Location of Chassis Lubrication Fittings

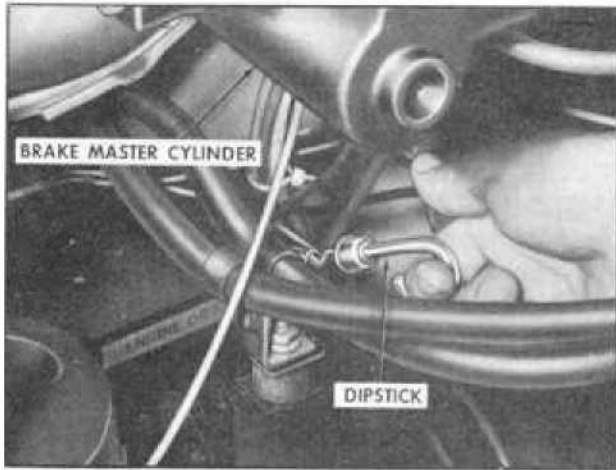

Removing Engine Oil Dipstick

To check the level, remove the oil level dipstick located inside the left front access door, wipe it clean and reinsert it fully for accurate reading. The oil level dipstick is marked "FULL" and "ADD." The oil level should be maintained within the margin, neither going above the "FULL" line nor below the "ADD" line. Reseat the dipstick firmly after taking the reading. One (1) quart will raise the oil level from "ADD" to "FULL."

NOTE: The oil dipstick is also marked "USE SE ENGINE OIL," as a reminder to use only SE oils.

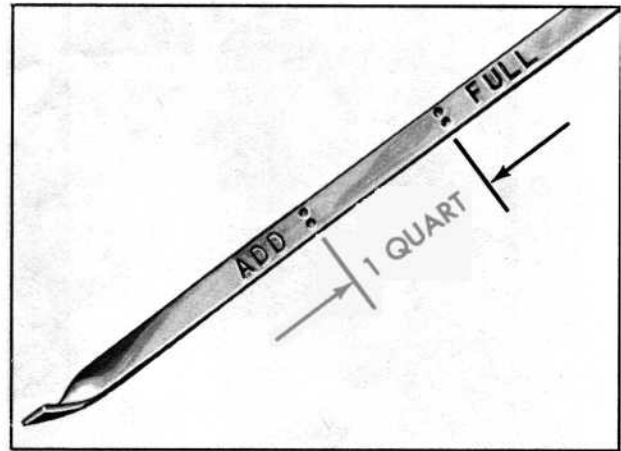

Engine Oil Dipstick

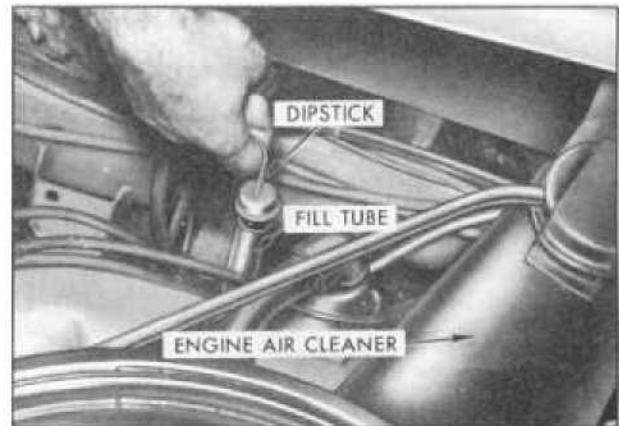

Removing Transmission Dipstick

TRANSMISSION

The transmission dipstick and fill tube is located under the engine access cover on the left side of the engine.

Use only automatic transmission fluids identified with the mark DEXRON® II. These fluids have been specially formulated and tested for use in your automatic transmission, and are available from your GMC MotorHome dealer or local service station.

Check the fluid level at each engine oil change period. To make an accurate fluid level check:

1. Drive vehicle several miles, making frequent starts and stops, to bring transmission up to normal operating temperature (approx. 190-200° F.).
2. Park vehicle on a level surface.
3. Apply parking brake.
4. Place selector lever in "PARK" and leave engine running.
5. Open all but the two rear windows, then remove engine cover.

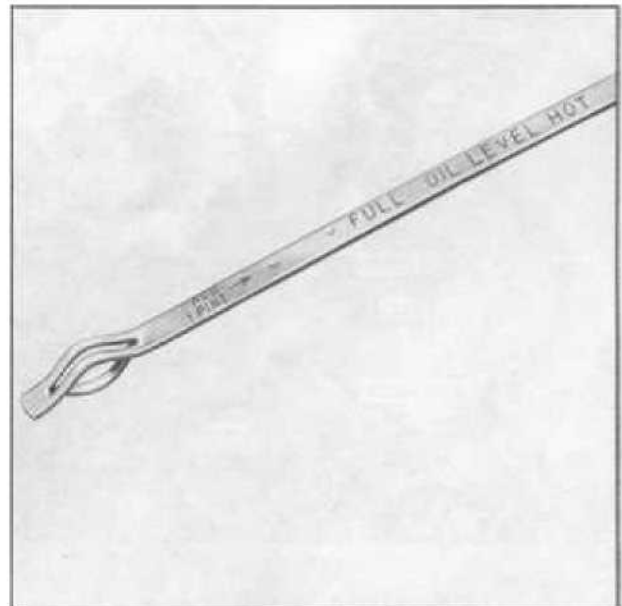

Transmission Dipstick

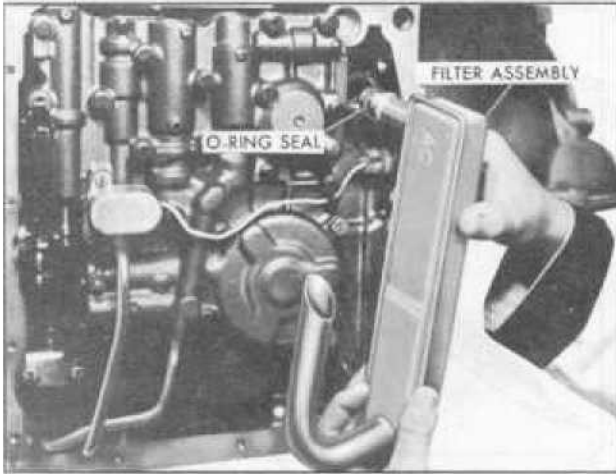

Replacing Transmission Oil Filter

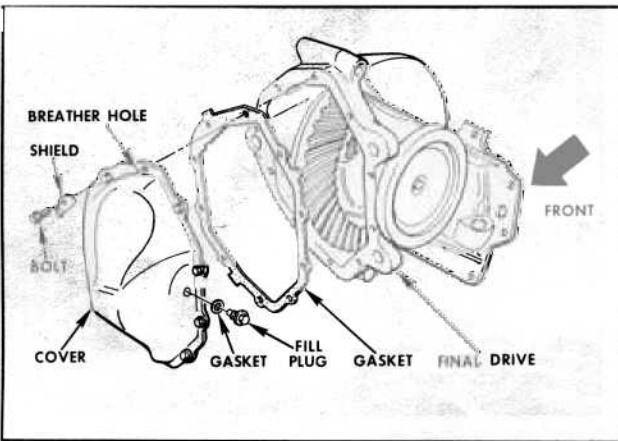

Final Drive Cover Removal

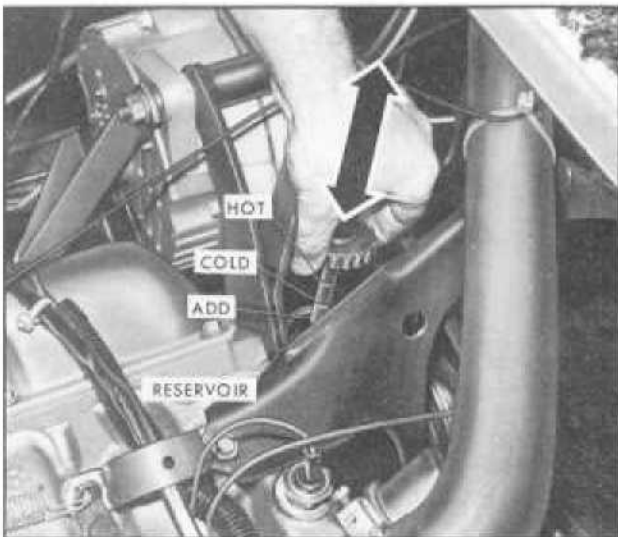

Checking Power Steering Fluid Level

6. Remove dipstick and wipe clean.
7. Reinsert dipstick until cap seats.
8. Remove dipstick and note reading.

If fluid level is at or below the "ADD" mark, add sufficient fluid to raise the level to the "FULL" mark. One pint raises the level from "ADD" to "FULL." Do not overfill. Refer to the Maintenance Schedule folder for servicing interval.

TRANSMISSION OIL FILTER REPLACEMENT

NOTE: Have a drain pan ready as lubricant will begin to drain as bolts are loosened.

1. Remove (13) bottom pan attaching screws.
2. Remove bottom pan and discard gasket.
3. Remove and discard oil filter assembly.
4. Install new O-ring seal on new filter and intake pipe and filter assembly and install.
5. Using a new pan gasket, install pan. Torque attaching screws to 12 foot-pounds.
6. Add four (4) quarts of DEXRON® II automatic transmission fluid and check fluid as noted above.

FINAL DRIVE

PART NO 2312PS

FINAL DRIVE LUBRICANT REPLACEMENT

1. Remove (10) cover attaching bolts. Have a drain pan ready as lubricant will begin to drain as bolts are loosened.
2. Remove cover and allow lubricant to drain. Discard old gasket.
3. Using a new cover gasket, install cover. Torque attaching bolts to 24 foot-pounds. Shield to be bent over breather hole.
4. Add four pints of recommended lubricant through fill plug hole or fill until lubricant level is at the plug hole. Install fill plug.

NOTE: Use SAE 80W or SAE 80W-90 GL-5 Gear Lubricant. (For those vehicles normally operated in Canada, use SAE 80W GL-5 Gear Lubricant.)

STEERING SYSTEM

POWER STEERING SYSTEM

Check the fluid level in the power steering pump reservoir at each oil change period. This requires the removal of the engine access cover. The reservoir is located near the Delcotron. Add

GM Power Steering Fluid (if GM Power Steering Fluid is not available, DEXRON® II Automatic Transmission Fluid may be used) as necessary to bring level into proper range on the filler cap indicator depending on fluid temperature.

If at operating temperature (approx. 150° F. —hot to the touch) fluid should be between “HOT” and “COLD” marks. If at room temperature (approx. 70° F.) fluid should be between “ADD” and “COLD” marks. The fluid does not require periodic changing.

STEERING LINKAGE

The steering linkage (tie rods) and suspension should be lubricated, using a Lithium Soap Multi-purpose grease that meets GM Specification 6031-M, at every oil change. Seals should be checked for damage (see Maintenance Schedule folder).

BRAKE SYSTEM

BRAKE MASTER CYLINDER

The master cylinder is located behind the left-side access door on the front of the vehicle. The fluid level in the master cylinder should be checked at each oil change. Wipe off the brake cylinder filler cap and unsnap the retainer. A low fluid level in the front brake master cylinder reservoir could be an indicator that the disc

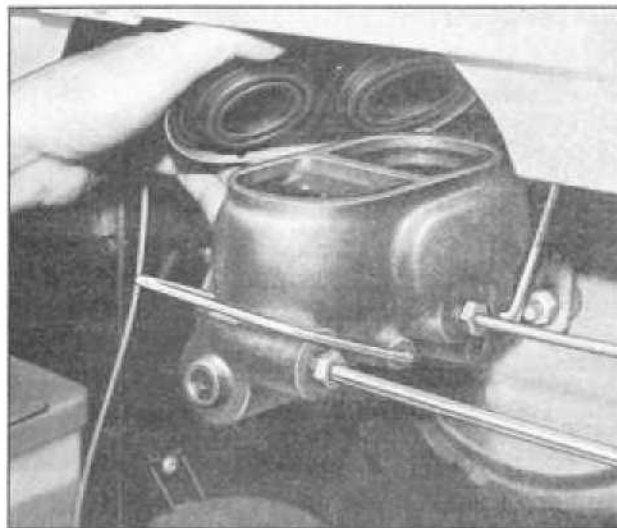

Checking Brake Master Cylinder

brake pads need replacing. The fluid level must be maintained at ¼-inch below the top of each reservoir with Delco Supreme No. 11 or DOT-3 Brake Fluid or equivalent. When replacing the cap be sure to fasten the retainer securely, taking care not to let dirt enter the reservoirs.

BLEEDING BRAKES

The need for bleeding brakes is generally indicated by springy, spongy pedal action. Pressure bleeding equipment must be used and a definite bleeding sequence and procedure must be followed. Consult your GMC MotorHome dealer.

SERVICING DETAILS

ENGINE COOLING SYSTEM

The recovery type cooling system is standard on all vehicles covered by this manual. The coolant expands with rising temperature and the overflow is collected in the recovery tank. When the system temperature drops, the coolant is drawn back into the radiator. The cooling system has been filled at the factory with a high-quality, inhibited, year-around coolant that meets the standards of General Motors Specification 1899-M. This coolant solution provides freezing protection to -20°F (-35°F in Canada), and it was formulated to be used without replacement for period specified in Maintenance Schedule folder, providing the proper concentration of coolant is maintained.



Coolant Recovery Tank

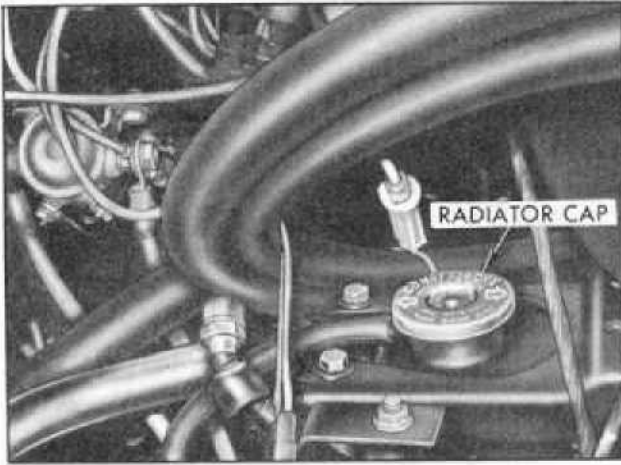

Location of Radiator Cap

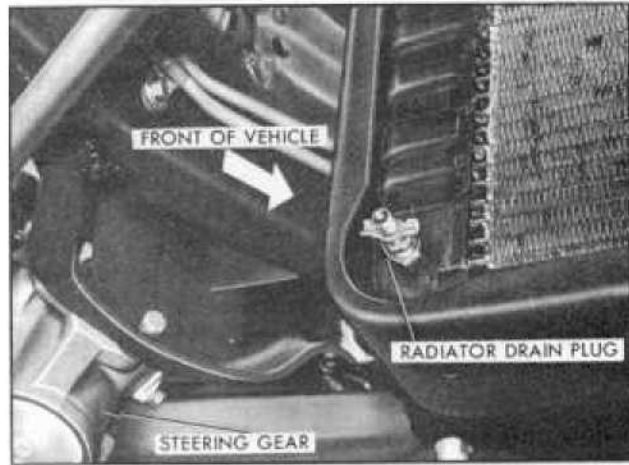

Radiator Drain Plug

COOLING SYSTEM CARE

Checking Coolant Level

Open right front access cover. Do not remove radiator cap to check coolant level, but check visually in the “see thru” coolant recovery tank as frequently as necessary. Level should be at the “COLD” mark on the recovery tank when the system is cold; and at the “HOT” mark at normal operating temperature. Add a 50/50 mixture of high-quality ethylene glycol anti-freeze and water to the recovery tank for coolant additions. If frequent additions are required, see your dealer for a cooling system check.

NOTE: If recommended quality antifreeze is used, supplemental inhibitors or additives claiming to provide increased cooling capability are not necessary. They may be detrimental to the efficient operation of the system, and represent an unnecessary operating expense.

Annual Service

The cooling system should be checked each year as follows:

1. Wash radiator cap and filler neck with clean water.
2. Check coolant for proper level and freeze protection.
3. Test system and radiator cap for proper pressure holding capacity (9 psi). If required, use cap designed by AC for coolant recovery systems and specified for your vehicle.
4. Tighten hose clamps and inspect all hoses. Replace hoses every 24 months, earlier if

swollen, checked or otherwise deteriorated.

5. Clean frontal area of radiator core and air conditioning condenser.

Draining and Refilling

The cooling system should be drained, flushed and refilled using the following recommended procedure at intervals specified in the Maintenance Schedule folder.

1. Remove radiator cap when engine is cool:
 - Rotate cap slowly counterclockwise to detent (Do not press down while rotating).
 - Wait until residual pressure (indicated by a hissing sound) is relieved, then press down on cap and continue to rotate counterclockwise.

CAUTION

To avoid the danger of being burned, do not remove radiator cap while engine and radiator are still hot because scalding fluid and steam will be blown out under pressure.

2. Run engine, with radiator cap removed, until upper radiator hose is hot (indicates thermostat is open).

3. Stop engine and open radiator drain valve to drain coolant. (Operation may be speeded by removing drain plugs in the block.)

4. Close valve (install block drain plugs, if removed) and add sufficient water to fill system.

5. Repeat steps 1, 2, 3, and 4 a sufficient number of times until the drained liquid is nearly colorless.

6. Allow system to drain completely and then close radiator drain valve tightly. (Install block drain plugs, if removed.)

7. Remove recovery cap leaving hoses in place. Remove coolant recovery tank, empty fluid, scrub and clean bottom and sides of tank with detergent and water, flush well with clean water, drain and reinstall.

8. Add sufficient ethylene glycol coolant, meeting GM specification 1899-M, to provide the required freezing and corrosion protection—at least a 50 percent solution (-20°). Fill radiator to the base of the radiator filler neck and bring level of coolant in the recovery tank to the "FULL HOT" mark. Reinstall recovery tank cap.

9. Run engine, with radiator cap removed, until radiator upper hose becomes hot.

10. With engine idling, add coolant to radiator until level reaches bottom of filler neck; install cap making certain arrows line up with overflow tube.

11. Add sufficient coolant to coolant reservoir to raise level to the "HOT" mark. Install reservoir cap.

IMPORTANT: MotorHome is equipped with water heater pre-heat, coolant level in coolant reservoir must be checked and coolant added, as necessary, after several hours of operation. The additional length of heater hose used in this system requires a longer period to normalize the coolant level.

Owner Responsibility

It is the owner's responsibility to:

- Maintain cooling system freeze protection at -20°F or below to ensure protection against corrosion and loss of coolant from boiling, even though freezing temperatures are not expected.
- Add ethylene glycol base coolant that meets GM Specification 1899-M when coolant additions are required because of coolant loss or to provide additional protection against freezing at temperatures lower than -20°F (-35°F in Canada).

NOTE: Alcohol or methanol base coolants or plain water are not recommended for your vehicle at any time.

THERMOSTAT

The cooling system is protected and controlled by a thermostat installed in the engine coolant outlet to maintain a satisfactory operating temperature of the engine. This thermostat is designed for continuous use through both winter and summer and need not be changed seasonally. When replacement is necessary, Delco parts are recommended.

ENGINE FUEL SYSTEM

FUEL REQUIREMENTS

Your vehicle's engine is designed to operate on unleaded gasoline of at least 91 Research Octane. The gasoline should also have a Motor Octane of at least 83. This gasoline will minimize spark plug fouling and emission control system deterioration. Regular grade leaded gasoline should be used only when needed to eliminate knock, a metallic rapping noise generated during the combustion process. The engine does not require Premium grade fuel. Thereafter, its use would be an unnecessary additional expense. If knocking persists, consult your authorized dealer. Continuous or excessive knocking may result in engine damage and constitutes misuse of the engine for which the manufacturing division is not responsible under terms of the new vehicle warranty.

NOTE: Some engines may be designed for unleaded gasoline **ONLY** and have provision for the prevention of use of leaded gasoline.

If the service station gasoline pump has a symbol similar to the one below, use unleaded gasoline with a symbol number of 2. Leaded regular grade gasoline (symbol number 3) should be used only when needed to eliminate knock. If the pump has a label indicating gasoline octane quality in terms of the average of

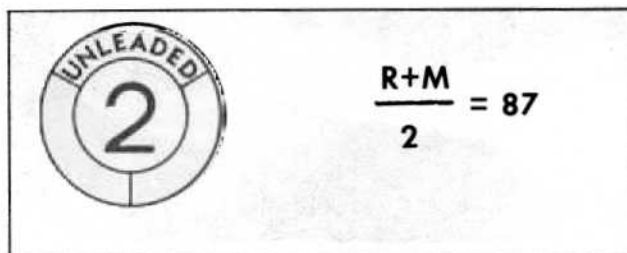

Gas Pump Symbols

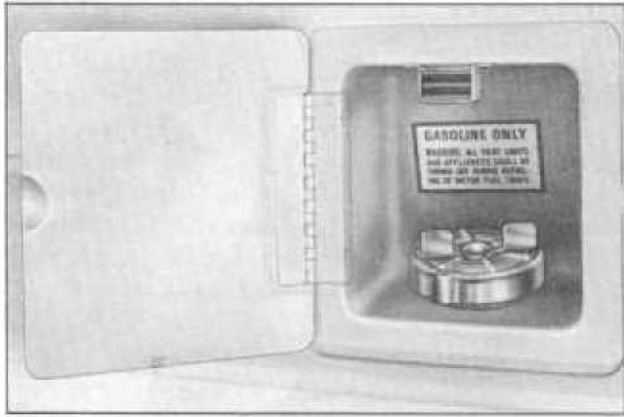

Gasoline Fuel Filler Compartment

Research and Motor Octane $\left[\frac{R + M}{2}\right]$ as shown on Page 71, use unleaded gasoline with a number of at least 87.

FUEL SYSTEM

The vehicle has two gasoline tanks of approximately 25 gallons each and a fuel switching device (see "FUEL SELECTOR" switch) which allows the driver to switch from the main tank (when empty) to the auxiliary tank.

The gasoline fuel filler compartment is located on the left side of the vehicle, directly under the driver's window.

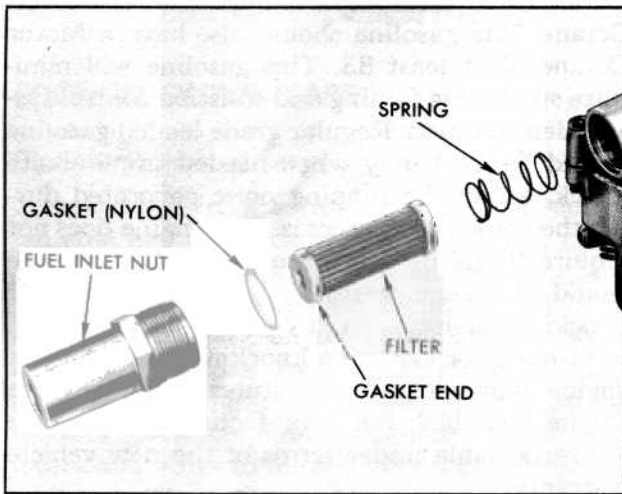

Fuel Filter Components

CAUTION

It is important that all pilot lights be turned off and open flames kept away when filling the fuel system to help reduce fire hazard.

GAS CAP—The cap is equipped with a double set of locking tangs.

To Remove:

- Rotate cap one-half turn counterclockwise to clear the first set of tangs from the slots inside the filler neck. This will allow any residual pressure to escape.
- Pull the cap outward and rotate one-quarter turn counterclockwise to clear second set of tangs. Then remove the cap.
- To install, reverse this procedure.

NOTE: If the gas cap requires a replacement, only a cap with the same features should be used. Failure to use the correct cap can result in a serious malfunction of the system. Correct replacement caps may be obtained from your GMC MotorHome dealer.



Removing Engine Air Cleaner Element

CARBURETOR

To obtain maximum engine performance and fuel economy, carburetor idle speeds should be checked as recommended in the Maintenance Schedule folder. If the engine stalls, idles too fast or slow, or idles roughly, the following adjustments should be performed. However, if the above symptoms persist it is recommended the vehicle be taken to a GMC MotorHome dealer.

NOTE: Refer to Tune-up label on engine for correct specifications.

Fuel Filter

To replace carburetor filter, disconnect fuel line, remove filter nut, gasket, filter, and spring. Install spring and element (open end of filter facing toward filter nut). Install gasket; tighten nut to 18 foot-pounds torque.

IMPORTANT: Tightening fuel inlet nut beyond specified torque can damage nylon gasket.

ENGINE AIR CLEANER

The air cleaner is a disposable type element. Replace the element as specified in the Maintenance Schedule folder. Do not wash, oil, or clean with air hose. The air cleaner will require more frequent service under dusty conditions. Your GMC MotorHome dealer can advise you on the proper interval. When replacement is necessary, an AC ACron air filter element is recommended.

CAUTION

DO NOT remove the engine air cleaner unless temporary removal is necessary during repair or maintenance of the vehicle. When the air cleaner is removed, backfiring can cause fire in the engine compartment.

CHASSIS ELECTRICAL SYSTEM

BATTERIES

There are two Delco Energizer Batteries used in the chassis and living area of the MotorHome. The main battery (or automotive battery) is located behind the right front access door. The auxiliary battery (living area battery) is located in the storage or motor generator compartment.

It is important that these batteries receive the following care:

1. Check the fluid level in each cell at each engine oil change interval and more often in hot weather. (To do this it may be helpful to use a small hand mirror.) Add only colorless, odorless drinking water or distilled water to bring the level to the split-ring in the filler opening. **DO NOT OVERFILL.**

2. Keep your batteries, battery cable terminals, and battery hold-down brackets clean. They should be cleaned every 12,000 miles or once a year. Use a brush and a solution of

ammonia and water or baking soda and water. Flush off with clear water. After cleaning apply petroleum jelly or petrolatum to battery cable terminals to help retard corrosion.

3. If battery performance becomes questionable see your dealer.

For full voltage requirements a Delco Energizer is recommended at replacement time.

CAUTION

Never expose battery to open flame or electric spark—chemical action in the battery generates hydrogen gas which is flammable and explosive. Do not allow battery fluid to contact eyes, skin, fabrics, or painted surfaces—fluid is a corrosive sulfuric acid solution which could cause serious personal injury or property damage. **FLUSH ANY CONTACTED AREA WITH WATER IMMEDIATELY AND THOROUGHLY. WEAR EYE PROTECTION WHEN WORKING ON OR NEAR BATTERY.** Remove rings, metal watchbands and other metal jewelry before working on or around a battery. Be careful in using metal tools and equipment. If such metals should contact the positive battery terminal (or metal in contact with it) and any other metal on the vehicle, a short circuit may occur which could cause personal injury. Batteries and battery acid should always be kept out of the reach of children.

For "Battery Jump Starting Procedure" see **IN CASE OF EMERGENCY** section.

DISTRIBUTOR

Distributor maintenance, which is the owner's responsibility, includes regular examination of the distributor cap for cracks, checking condition of ignition wires, maintaining serviceable distributor points, and proper ignition timing at specified intervals. Refer to the Maintenance Schedule folder for additional information.

NOTE: Refer to Tune-up label on engine for correct specifications.

SPARK PLUGS

The frequency of spark plug service intervals is explained in the Maintenance Schedule folder. Servicing is the owner's responsibility. Before

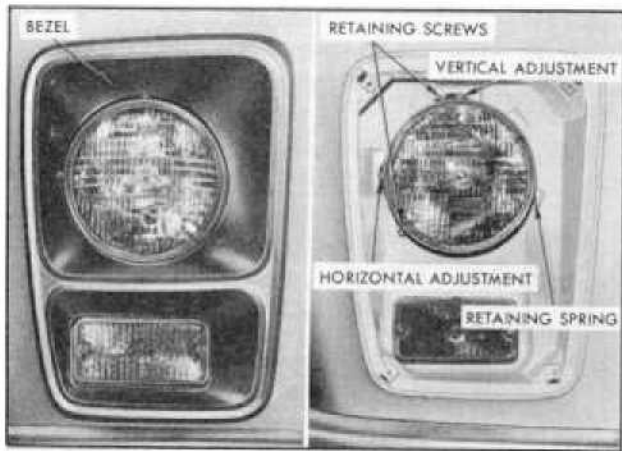

Headlight Replacement

removing plugs, clean plug wells thoroughly, clean the threads and seats in the cylinder heads to assure proper seating and heat transfer.

HEADLIGHTS

Make a headlight beam adjustment check a regular part of your "Safety Maintenance" program. Sealed-Beam units are No. 6014 which are equipped with ground guide points for the use of a mechanical aiming device. Your authorized dealer is best qualified to adjust your headlights.

Headlight Beam Adjustment

NOTE: Cutouts in headlight bezel permit access to adjustment screws.

Headlights should be adjusted properly. The top adjusting screw provides vertical adjustment and the side adjusting screw provides horizontal adjustment. Headlights should not have to be adjusted after replacing Sealed-Beam unit, providing headlights were in proper adjustment before replacement and adjusting screws were not disturbed during replacement.

Headlight Replacement

To replace a Sealed-Beam unit, remove bezel. Then disengage the tension spring using a stiff hooked tool. Rotate the Sealed-Beam assembly slightly to disengage mounting ring slots from groove of each adjusting screw, then pull forward. Disconnect wiring at the base of unit and separate the Sealed-Beam assembly by removing the two retaining screws. Install Sealed-Beam unit in reverse order of removal.

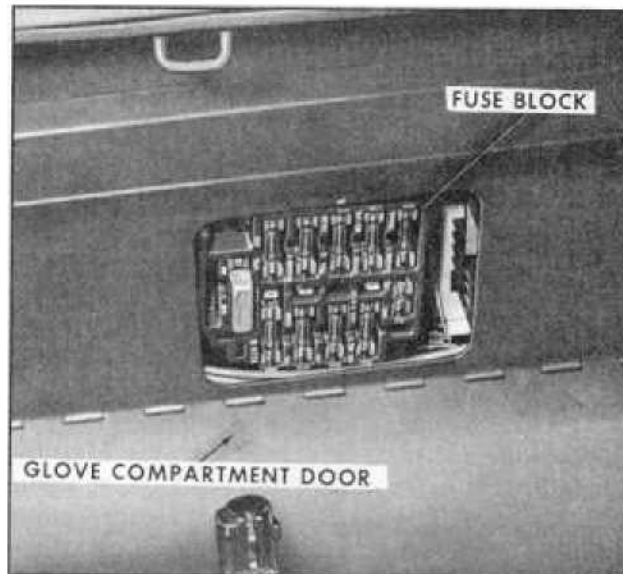

Chassis Fuse Block

EXTERIOR LIGHTS

All exterior lights can be easily replaced by removing lens, pushing bulb in slightly and turning counterclockwise, except side marker lights which are simply pressed in. Then, with new bulb, reverse procedure.

CHASSIS FUSES, FUSIBLE LINKS, CIRCUIT BREAKERS

The wiring circuits in your vehicle are designed to be protected from short circuits by a combination of fuses, circuit breakers, and fusible thermal links in the wiring itself. This helps to reduce the hazard of electrically-caused fires in the vehicle.

The fuse and circuit breaker block is located behind an access cover in the glove compartment. All chassis circuits are protected by fuses or circuit breakers located here except:

- **HEATER BLOWER**—Which has a 30-amp in-line fuse located behind the right access door near the heater blower motor.
- **HEADLAMP CIRCUITS**—Are protected by a circuit breaker in the main light switch. An electrical overload in the light circuit will cause the lights to go on and off or in some cases to remain off. If this condition develops, have the wiring circuits checked immediately.

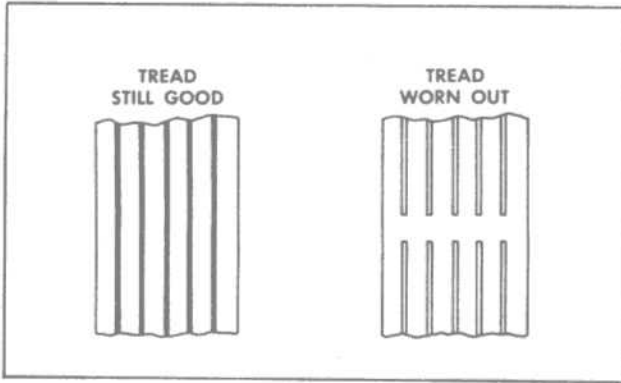

Tire Tread Wear Indicator

Tire Damage and Repair

Tires with cuts, splits or cracks deep enough to expose the fabric, should be removed from service. Bulges usually indicate internal damage, and the tire should be removed. Tires with questionable damage should be removed from the wheel and examined by an expert.

If an air loss occurs while driving, do not attempt to drive on the deflated tire more than is necessary to stop safely. Driving even a short distance can damage a tire beyond repair.

Temporary repairs, such as “blowout” patches or any repair made from the outside of the tire should not be made except in emergencies. Such “stop-gap” devices as plugs and aerosol-type sealants are good for not more than 100 miles of driving at speeds not over 50 MPH. A permanent vulcanized repair, plug or patch applied from inside the tire, should be made as soon as possible. Also, the installation of an inner tube in a damaged tubeless tire is not a recommended repair procedure.

Replacement Tires

When replacing tires, only the size (8.75-16.5), load range (“D”), construction type (bias-ply polyester cord, or bias-ply steel belted) are recommended for installation on the vehicle.

CAUTION

Radial tires are not recommended for installation on the vehicle. Severe damage and possible injury could result.

Use of any other tire may seriously affect ride, handling, speedometer/odometer calibration, ve-

hicle ground clearance and tire clearance to the body and chassis. The following also should be considered when replacing tires:

- To achieve best all-around vehicle performance, bias-ply and bias-ply steel belted tires should not be mixed on the same vehicle.
- It is recommended that new tires be installed in pairs opposite each other (preferably the front wheels).
- When replacing only one tire, it should be paired with the tire having the least wear, to equalize braking traction.

Replacement Wheels

Wheels must be replaced if they become bent, are heavily rusted, if the lug nuts won't stay tight, or if they leak air. Straightening bent wheels or using inner tubes in leaking wheels are not recommended repair procedures.

When replacing wheels for any reason, care should be taken to insure that the wheels are equivalent to those removed in load capacity, diameter, rim width, and offset. Correct replacement wheels can be obtained from your GMC MotorHome dealer.

Use of any other size or type wheel may adversely affect wheel and wheel bearing life, brake cooling and stopping ability, headlamp aim, speedometer-odometer accuracy, bumper height, vehicle ground clearance and tire clearance to the body and chassis.

The use of used wheels is also not recommended; if they have been run overloaded or under other severe operating conditions for extended periods, the wheel's life may have been greatly shortened.

Tire Warranty

Tires are warranted by the tire manufacturers as covered in the New Vehicle Warranty folder.

Tire Traction

A decrease in driving, cornering, and braking traction occurs when water, snow, ice, gravel, or other material is on the road surface. Driving practices and vehicle speed should be adjusted to the road conditions.

When driving on wet or slushy roads, it is possible for a wedge of water to build up between the tire and road surface. This phenomenon, known as hydroplaning, may cause partial or complete loss of traction, which adversely

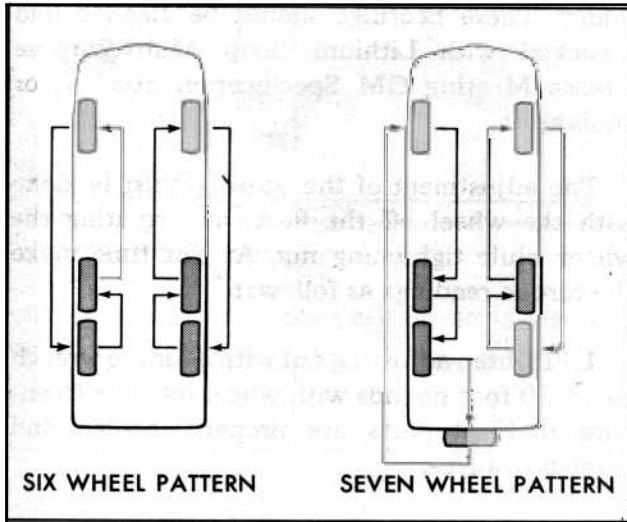

Tire Rotation Diagram

affects vehicle control and stopping ability. To reduce the possibility of traction loss, the following precautions should be observed:

1. Slow down during rain-storms or when roads are slushy.
2. Slow down if road has standing water or puddles.
3. Replace tires when tread wear indicators are visible.
4. Keep tires properly inflated.

Snow Tires

If the vehicle is expected to encounter muddy or snowy driving conditions it is recommended that front driving wheels be equipped with mud and snow type tires.

If you equip your vehicle with mud and snow tires, they should be of the same size, load range, and construction as original equipment tires. It is recommended that vehicle speeds be limited to a maximum of 75 mph if mud and snow tires are installed.

Tire Wear and Rotation

Uneven or abnormal tire wear is usually the result of incorrect inflation pressure, improper wheel alignment, wheels being out-of-balance, or poor driving habits. Under-inflation, over-infla-

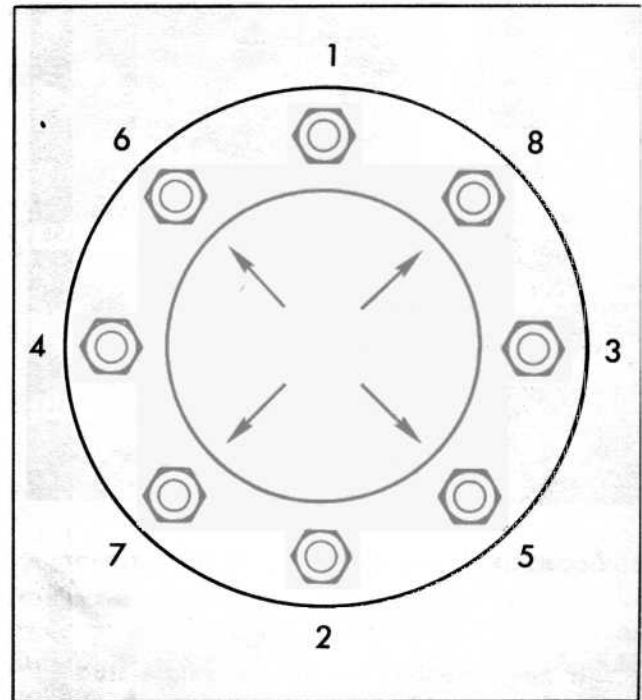

Wheel Stud Tightening Sequence

tion, incorrect toe or camber and fast cornering produce different types of abnormal wear which can be diagnosed by your dealer.

To equalize wear it is recommended that the tires be rotated every 6,000 miles (or sooner if irregular wear develops) as shown.

NOTE: It is recommended that disc brake pads be inspected for wear whenever tires are rotated.

The original equipment tires incorporate built-in tread wear indicators to assist you in determining when your tires have worn to the point of needing replacement. These indicators appear as $\frac{1}{2}$ -inch wide bands when tire tread depth is $\frac{1}{16}$ -inch or less. When the indicators appear in two or more adjacent grooves, tire replacement due to tread wear is recommended.

Tightening Wheel Stud Nuts

When the vehicle is new or after wheels have been replaced, it is the owner's responsibility to check wheel stud nuts at 500 miles and after every wheel removal thereafter. Nuts should be tightened to 250 foot-pounds torque in sequence shown.

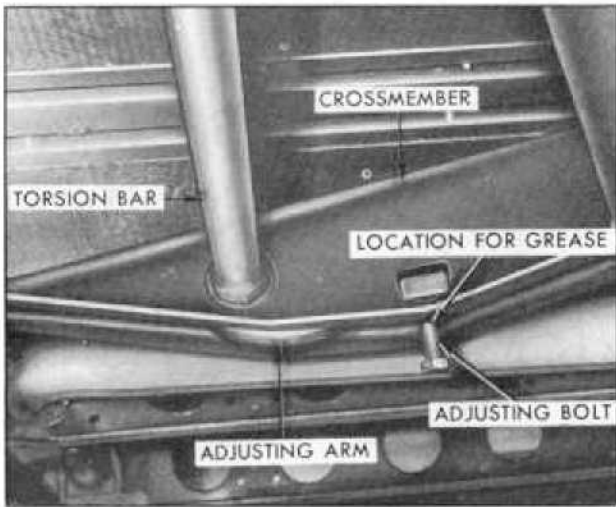

Location—Front Ride Height Adjustment

CAUTION

If any wheel experiences a single stud failure caused by a loose-running wheel, all wheel studs should be replaced.

A loose-running wheel may cause only one stud to break, but several more studs may become fatigued to the point of failure, but not actually breaking. Replacing only the broken stud and re-mounting wheel will then set the stage for a second and possibly more serious failure. If holes in the wheel have become elongated or enlarged, replace wheel.

Tighten wheel stud nuts as follows:

1. Install all nuts loosely, then finger-tighten only the nuts marked by arrows.
2. Tighten all nuts to specified torque in sequence illustrated. Never use oil or grease on studs or nuts.

See **IN CASE OF EMERGENCY** section for procedure used to change tire.

FRONT WHEEL BEARING

Periodic maintenance on the front wheel bearing is not required. The front wheel bearing is a sealed bearing and non-adjustable.

REAR WHEEL BEARING ADJUSTMENT

A periodic rear wheel bearing repack is required as indicated in Maintenance Schedule

folder. These bearings should be cleaned and repacked with Lithium Soap Multi-Purpose Grease Meeting GM Specification 6031-M or equivalent.

The adjustment of the bearing must be done with the wheel off the floor, and rotating the wheel while tightening nut. At this time make the torque readings as follows:

1. Tighten adjusting nut with a torque wrench to 25-30 foot-pounds with wheel rotating to ensure that all parts are properly seated and threads are free.

2. Back off nut one-half turn. Re-tighten nut finger-tight.

3. If unable to install cotter pin at finger-tight position, back off one slot, then secure with cotter pin.

4. End play should be .001" to .005". Also at this interval the rear suspension control arms should be lubricated. This is accomplished at the fittings between the rear wheels.

FRONT SUSPENSION

The front suspension consists of control arms, stabilizer bar, shock absorbers and a right and left torsion bar. The front suspension components are designed to provide satisfactory service, ride, and handling if not overloaded and adjusted to specified vehicle front end ride height.

No maintenance other than lubrication is normally required. Refer to lubrication information given earlier in this section for intervals and lubrication points.

The front of the torsion bar is attached to the lower control arm. The rear of the torsion bar is mounted into an adjustable arm. The front ride height is controlled by this adjustment.

The simplest way to adjust is to move arm slightly to achieve ride height and drive unit a few blocks so as to overcome delaying action.

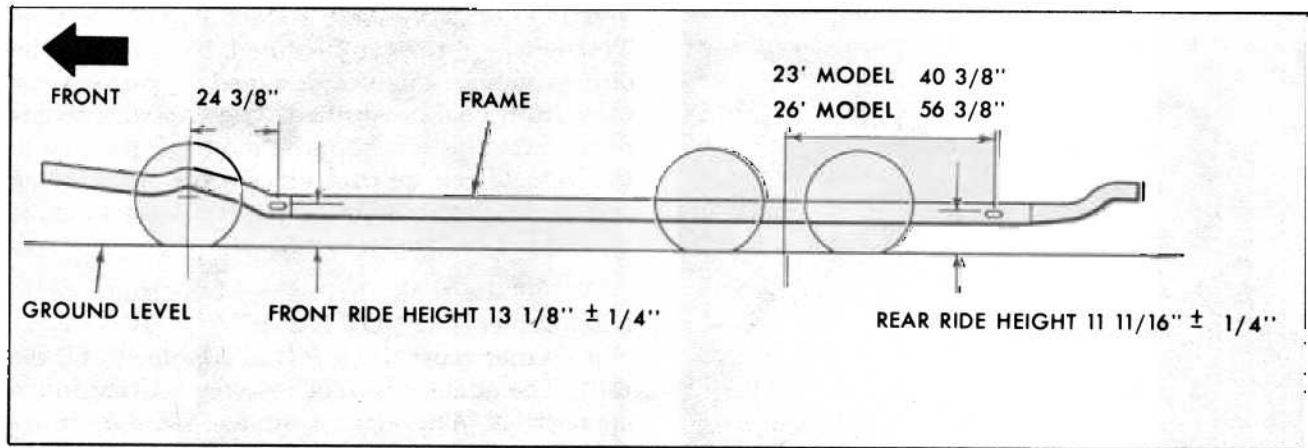

Checking Vehicle Ride Height

NOTE: Ride height is measured from top of elongated slot in frame rail to ground level. Tire inflation should be checked prior to making any ride height adjustment.

Ride height should be adjusted by raising vehicle to relieve strain on adjusting bolt. Lubricate adjusting bolt with chassis grease. Adjustment is made by repositioning adjusting bolt to wind-up and unwind torsion bar. Whenever ride height is changed, be sure to check front end alignment and readjust if necessary.

NOTE: Overloading and incorrect ride height can create serious problems and shorten the service life of the vehicle. Adjust front suspension ride height to specifications shown.

REAR SUSPENSION

The rear suspension consists of control arms, mounting brackets, air bellows, shock absorbers, air compressor, air reserve tank, and height control valves. The system operates automatically as load varies, and is designed to maintain a constant frame height.

NOTE: Ride height is measured from top of elongated slot in frame rail to ground level. Tire inflation should be checked prior to making any ride height adjustments.

The rear suspension can be manually adjusted for variations in load distribution. Adjustment is made at the adjustment nut on the height control valve arm.

MAINTENANCE

1. Drain air reservoir under front of vehicle to remove moisture.

2. The air compressor must periodically have the air filter washed with soap and water solution or replaced. Filter should be serviced at intervals specified in Maintenance Schedule folder.

NOTE: Occasionally check air bellows to see if they are caked with accumulated mud deposits. If deposits are present remove them from air bellows.

UNDERBODY MAINTENANCE

The effects of salt and other corrosive materials used for ice and snow removal and dust control can result in accelerated rusting and deterioration of underbody components such as brake and fuel lines, frame, exhaust system, brackets, parking brake cables. These corrosive

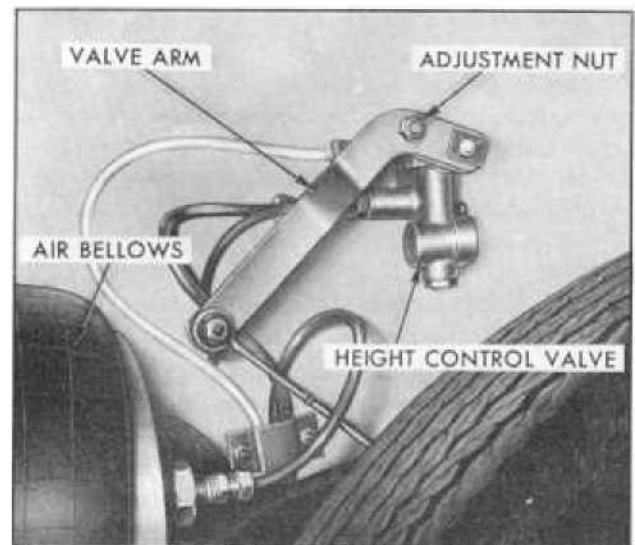

Location—Rear Ride Height Adjustment

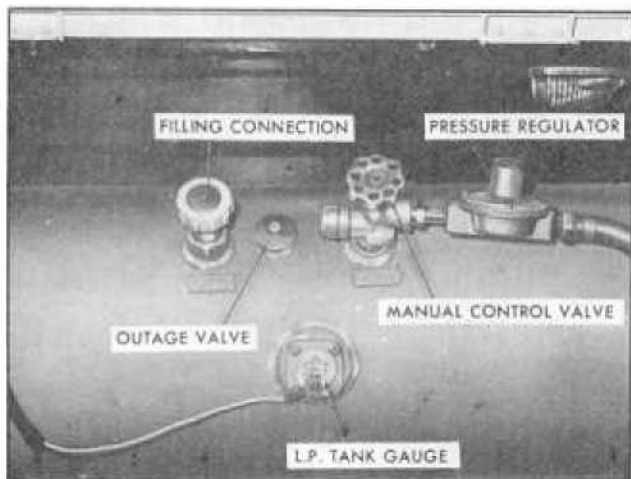

LP Gas Tank Controls

effects, however, can be reduced by periodic flushing of the underbody with plain water. In geographic areas having a heavy concentration of such corrosive materials, it is recommended that the complete underbody be inspected and flushed at least once each year, preferably after a winter's exposure. Particular attention should be given to cleaning out underbody members where dirt and other foreign materials may have collected.

If desired, your MotorHome dealer can perform this service for you. In addition, he can provide recommendations on undercoating materials which will help protect your vehicle from corrosion. (See "Undercoating" in APPEARANCE CARE section.

LP GAS SYSTEM

CAUTION

If gasoline or LP gas fumes are noticed at any time, the cause should be determined and corrected without delay because of the possibility of fire.

Bottled LPG (Liquid Petroleum Gas) is safe, economical, clean and conveniently available. It operates the kitchen stove and furnace in your MotorHome, as well as the gas/electric refrigerator, if so equipped.

The tank is located on the right side of the vehicle in a compartment behind the rear wheels. The tank is accessible only from outside of the vehicle.

The knob on the left is the filling connection. This is where the tank is filled. Next to it is the outage valve, which is designed to prevent the tank from being overfilled. The control valve is next to it. This is where the main LP gas line to the vehicle can be shut off. On the line leading out of the control valve is the regulator valve. It should not be tampered with.

To fill the tank, drive the MotorHome to an LPG Dealer (**DO NOT REMOVE THE TANK**). The Dealer must use a P.O.L. adapter to fill the tank. The adapter is to be inserted into the filling connection. When liquid appears at the outage valve the tank is full.

Always refill empty LP gas tank as soon as possible. Appliances will stop working when the gas supply becomes exhausted.

When you are not using the gas appliances, shut off the control valve on the tank; this will help prevent moisture from condensing inside the tank. Having a small amount of Methyl Alcohol put in the tank when you have it filled will help prevent moisture in the tank and help prevent the lines from freezing in the winter.

You may find that in the southern part of the country only Butane is available for your LPG tank. It will work fine except that at temperatures below 30°F. Butane is in a liquid state. In this temperature range no vapor is produced to fuel the appliances. If you expect to encounter temperatures below 30°F., discharge the Butane from the tank and refill the tank with propane gas. Propane gas does not vaporize below a temperature of -44°F.

When opening the valve to operate the system, open it all the way, then close it one-quarter turn. This will enable you to tell if the valve is open or closed.

CAUTION

BEFORE opening the control valve check that controls for all gas appliances are in the OFF position. If this is not done, LP gas could accumulate inside the vehicle creating a fire or explosion hazard.

DO NOT alter LPG tank in any way. The regulator on the tank is pre-set. DO NOT attempt to adjust it. This should be done by an authorized service outlet.

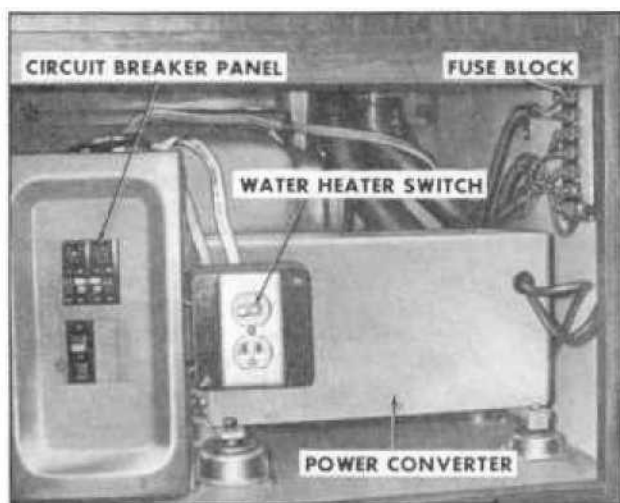

Living Area Electrical Compartment

It is recommended that you travel with your LPG system off. All pilots and burners should be turned off and the control valve on the LPG tank should be off. This should also be done whenever the vehicle will not be in use. This reduces the hazard of leaking gas.

LIVING AREA ELECTRICAL SYSTEM

Both the 12-volt DC and 120-volt AC circuits in the MotorHome living area are designed to be protected by a series of fuses and circuit breakers. The 12-volt living area circuits are protected by automotive-type fuses, and the 120-volt circuits are protected by circuit breakers like those found in modern homes.

The 12-volt living area fuse block is located in the electrical compartment, next to the hall closet, along with power converter and main circuit breaker panel. In the event of an overloaded circuit, the cause should be corrected and a new fuse of the same capacity installed. For explanation of 12-volt fuse block number code, refer to **GENERAL DATA AND SPECIFICATIONS** later in this manual.

The main circuit breaker panel, also located in the living area electrical compartment, contains circuit breakers that are designed to snap to the "OFF" position in the event of an overloaded 120-volt circuit. Once the cause of the overload is corrected the circuit breaker switch may be moved back to the "ON" position.

The 120-volt / 12-volt power converter, located in the living area electrical compartment,

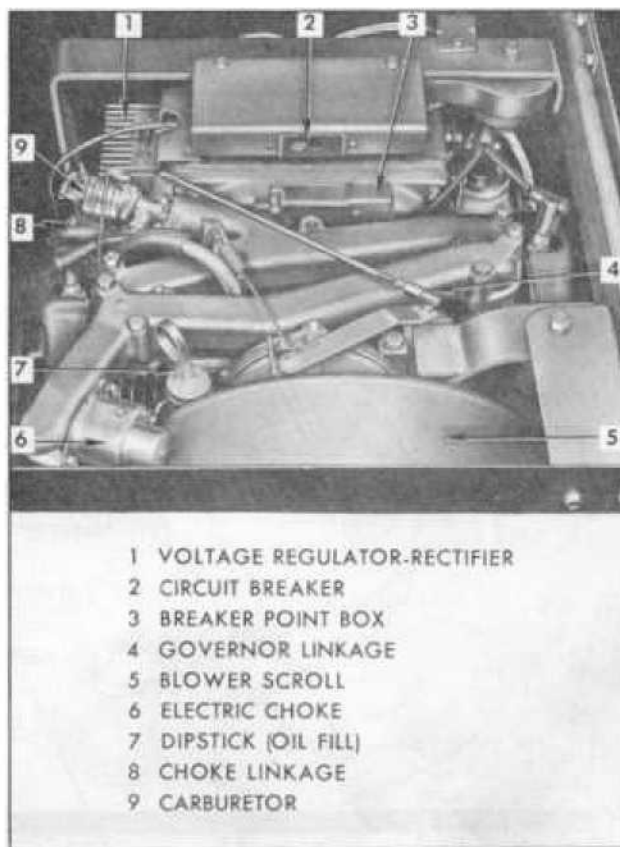

Onan Motor Generator (Top View)
(4000 Watt Unit Shown)

CAUTION

Do not use living area electrical compartment as a storage area. The power converter must have a free flow of air through and around the unit. If air flow is restricted, the converter could overheat which could result in malfunction and permanent damage. Do not let unit get wet, but do keep it as clean as possible to help assure its long life. The converter can be cleaned with low pressure air (30 PSI maximum) if necessary.

ONAN MOTOR GENERATOR MAINTENANCE

SERVICE INTERVALS

For service intervals refer to the Maintenance Schedule folder.

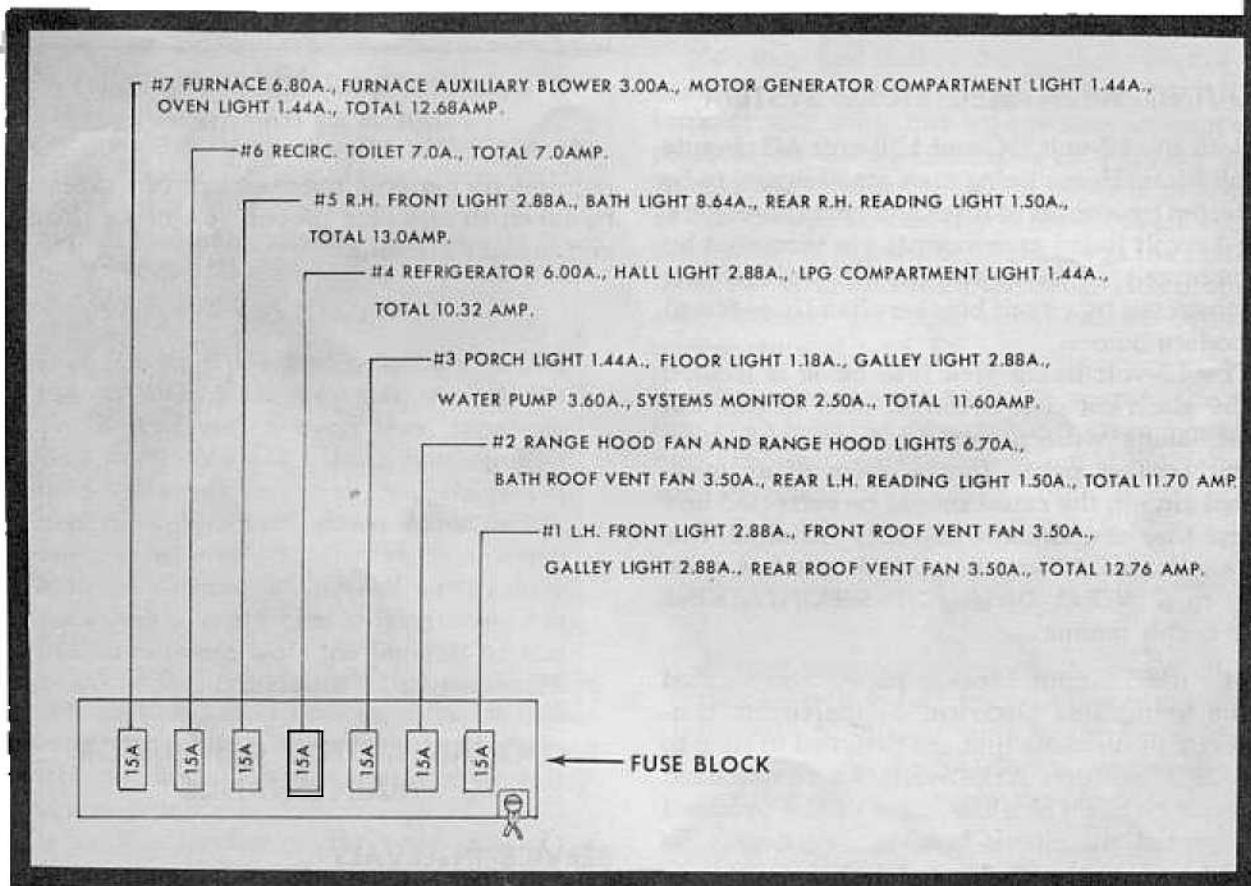
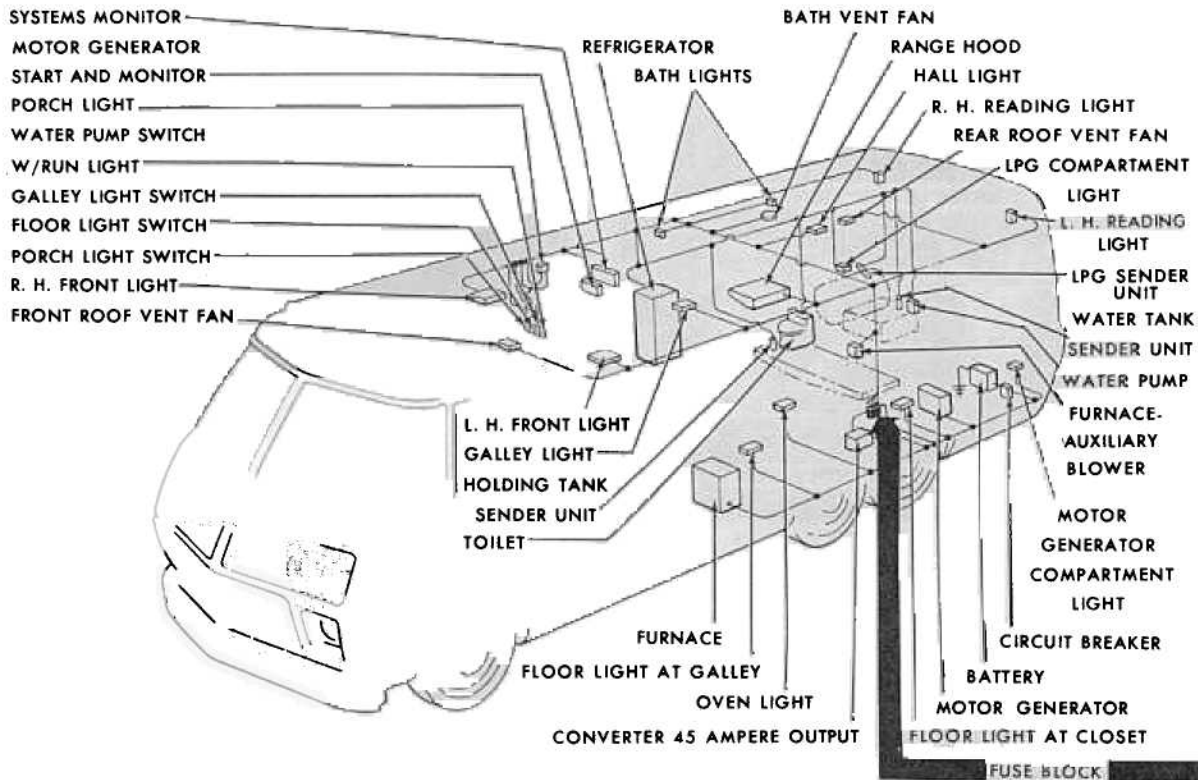

Living Area 12-Volt DC Electrical System (Typical)

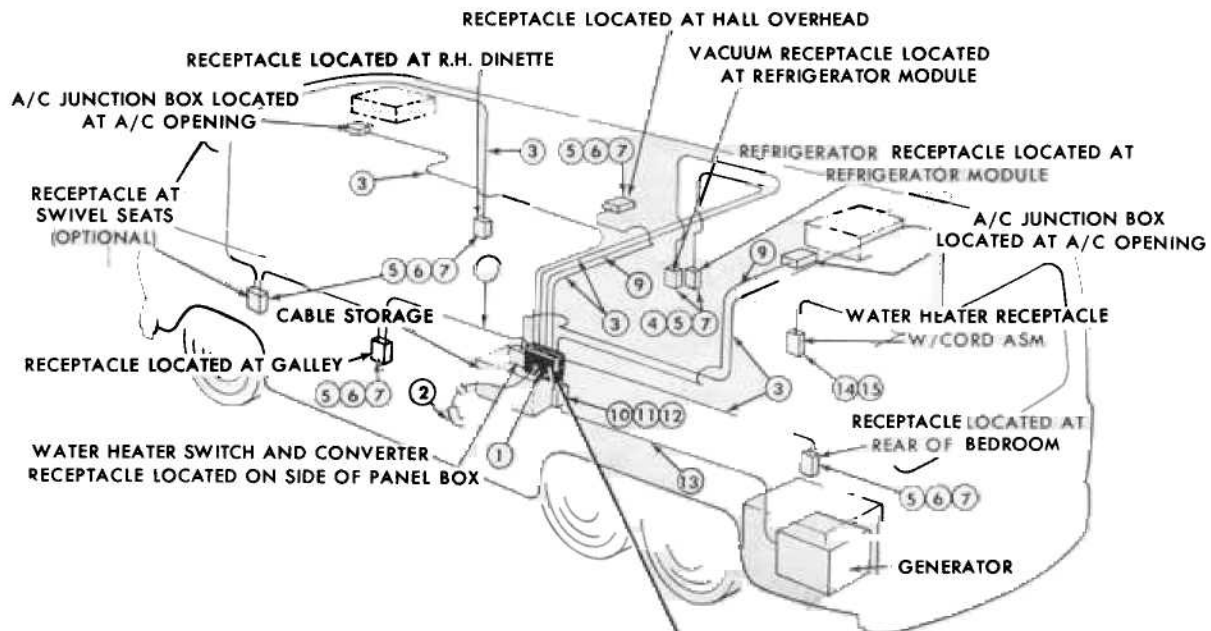

ITEM NO	PART NAME
1	MAIN PANEL BOX
2	#8-4 WIRE CORD TYPE '50' W/PLUG
3	WIRE 12/2 W/GROUND WIRE
4	SINGLE RECEPTACLE
5	OUTLET BOX
6	DUPLEX RECEPTACLE
7	OUTLET PLATE
8	SWITCH & RECEPTACLE
9	14/2 W/GROUND WIRE
10	3 POLE 4 WIRE RECEPTACLE
11	OUTLET BOX
12	OUTLET PLATE
13	#6-2 WIRE CORD IN METAL CONDUIT
14	'J' BOX
15	BLANK COVER PLATE

CIRCUIT BREAKER PANEL				
CIRCUIT #1	CIRCUIT #2	CIRCUIT #3	CIRCUIT #4	CIRCUIT #5
FRONT AIR COND. RECEPT.	WATER HEATER RECEPT.	HALL OVER	VACUUM RECEPT.	REAR AIR COND. RECEPT.
	CONVERTER RECEPT.	BEDROOM RECEPT.		
		GALLEY RECEPT.		
		SWIVEL CHAIR RECEPT.(OPT.)		
		R.H. DINETTE RECEPT.		
		REFRIGERATOR RECEPT.		

A-3699

120-Volt AC Electrical System (Typical)

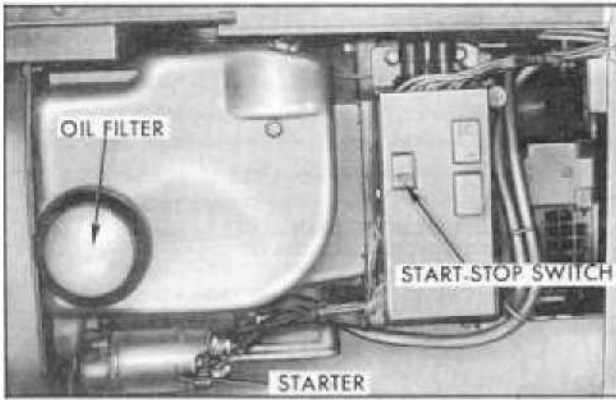

*Onan Motor Generator (Right Side View)
(4000 Watt Unit Shown)*

CHECKING OIL LEVEL

Check the oil level daily, or at least every eight hours of operating time. Check more often on a new unit as oil consumption is generally higher until piston rings seat properly.

CHANGING OIL

Initial oil change should be made after the first 25 hours of operation; change every 100 hours after that. If operating in extremely dusty or cold weather conditions, change oil more frequently.

The 4KW Model has an oil capacity of 3 quarts, 3½ quarts if replacing oil filter.

The 6KW Model has an oil capacity of 4 quarts; 4½ quarts if replacing oil filter.

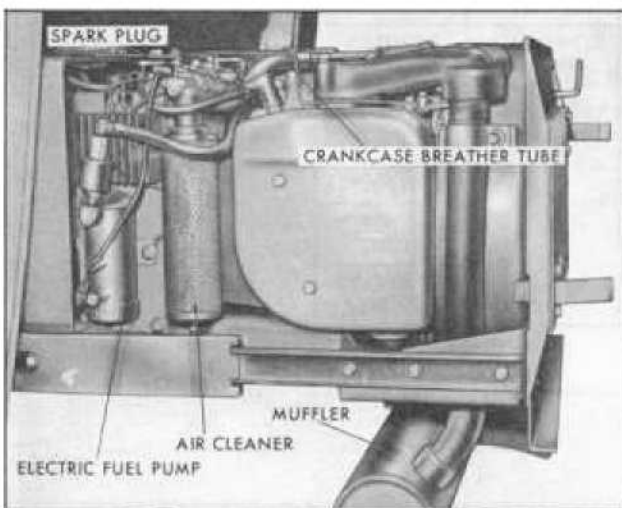

*Onan Motor Generator (Left-Side View)
(4000 Watt Unit Shown)*

Do not mix brands or grades of motor oil. Use a good quality oil with the designation SE/CC. If necessary to add oil between changes, use the same brand and grade of oil.

Use the following chart as a guide for the proper oil according to temperature ranges:

TEMPERATURE	RECOMMENDED OIL
Above 30°F.	SAE 30
0°F. to 30°F.	SAE 5W30 or 10W40
Below 0°F.	SAE 5W30

NOTE: Fill engine with oil through dipstick tube.

The oil drain plug is located on the bottom side of the engine oil base. Unit must be pulled out on its slide rail to gain access.

OIL FILTER

Change the crankcase oil filter at least every 200 hours. The filter is located on the right side of the unit (facing the compartment). Remove by turning counterclockwise with a filter wrench. Before installing new filter, coat the gasket on the filter's base with a light film of new oil. Install by turning clockwise until a light friction is noted, then turn an additional ¼ to ½ turn.

CAUTION

Do not over-tighten filter as damage may occur to rubber gasket which will cause filter to leak. Be sure to install sealing ring around filter; this ring is an air seal to prevent cooling air loss.

FUEL PUMP FILTER ELEMENT

Every 400 hours drain the fuel pump and check filter element. Remove fuel pump mounting screws and turn off hex nut on base of pump. If element appears dirty, replace with a new one. Be sure to replace gaskets when reassembling.

GOVERNOR

The governor controls the speed of the unit by opening or closing the throttle according to the load placed on the motor generator. Every 200 hours check governor linkage for freedom of movement through its entire travel. Clean and lubricate ball joint with graphite grease.

Motor Generator is cranked from auxiliary (living area) battery. See "Chassis Electrical System" earlier in this section.

SPARK PLUGS

Check, clean and reset spark plugs every 100 operational hours. Replace spark plugs that show signs of fouling or electrode erosion. It is recommended that spark plugs be replaced at the beginning of each new season.

COOLING SYSTEM

The motor-generator is cooled by a flywheel blower fan which pulls air over the cylinders and cooling fins. The air path is directed by sheet metal shrouds and plates. These shrouds and plates must always be installed properly so unit does not overheat.

Check and clean the cooling fins every 200 hours of operation. Remove any dust, dirt or oil which may have accumulated. Check compartment air inlet and air outlet for build-up of dirt, etc.

AIR CLEANER

Check and clean the air cleaner element at least every 100 operational hours. Loosen wing nut to remove. Clean by tapping base lightly on a flat surface. Replace element at least every 200 hours on the 4KW Model and every 500 hours on the 6KW Model. Clean or replace more often in dusty conditions.

CAUTION

Do not remove the air cleaner unless temporary removal is necessary during repair or maintenance. When the air cleaner is removed backfiring can cause fire in the generator compartment.

BREAKER POINTS

To maintain maximum efficiency from the unit, change the breaker points every 200 hours of operation. To change the breaker points use the following procedure:

1. Remove the two screws and the cover on the breaker box.

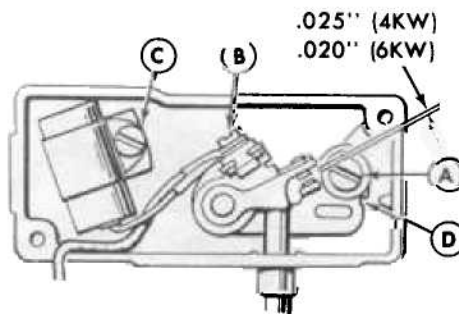

Onan Breaker Point Adjustment

2. Remove the two spark plugs so the engine can easily be rotated by hand. Check condition of spark plugs at this time.

3. Remove mounting screw (A) and pull the points out of the box just far enough so screw (B) can be removed and leads disconnected.

4. Remove screw (C) and replace condenser with a new one.

5. Replace points with a new set but do not completely tighten mounting screw (A).

6. Remove the access hole cover on the top of the blower housing. This provides an access to view timing mark.

7. Rotate the engine clockwise (facing flywheel) by hand until the 26° BTDC mark on gear cover aligns with mark on flywheel on the 4KW Model. On the 6KW Model, rotate it to the 25° BTDC mark. Turn another ¼ turn (90°) to ensure points are fully open.

8. Using a screwdriver inserted in notch (D) on the right side of points, turn points until gap measures .025" (4KW Model) and .020" (6KW Model) with a flat thickness gauge (be sure gauge is clean). Tighten mounting screw (A) and recheck gap.

CARBURETOR

The carburetor has a main fuel (power) adjustment and an idle fuel adjustment. The main adjustment affects operation under heavy load conditions. Idle adjustment affects operation under light or no-load conditions. Under normal circumstances, factory carburetor adjustments should not be disturbed.

On the 6KW Model the normal settings are 1 5/8-turn open for main fuel adjustment and one turn open for idle fuel adjustment.

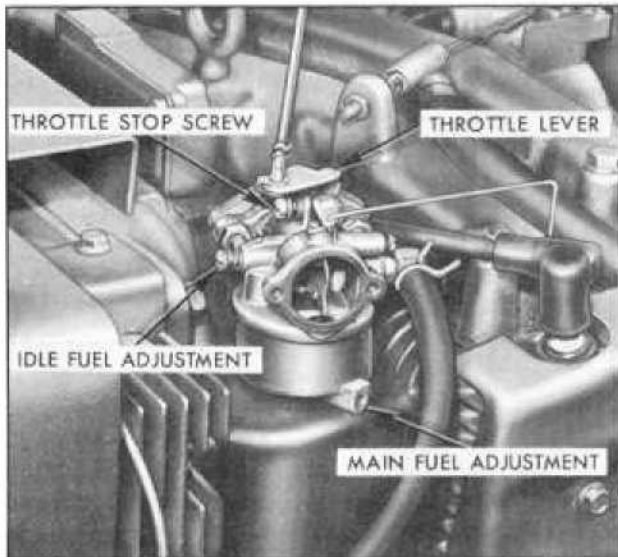

*Onan Motor Generator
Carburetor Adjustment Points*

IMPORTANT: Forcing the needle against its seat will damage it. The needle does not completely shut off fuel when turned fully in.

Before final adjustment, allow the engine to warm up. Make the idle adjustment under no load. Open the main fuel adjustment until the engine runs smooth under acceleration with no load. Slightly more fuel may be needed (open about $\frac{1}{4}$ -turn further) when sudden load is applied or if operating in very cold weather. Set the throttle stop screw with no load connected and while running at a low speed setting. Turn the screw to give approximately $\frac{1}{32}$ -inch between the throttle stop screw and throttle lever.

On the 4KW Model the normal setting is to turn the idle fuel adjustment and the main fuel adjustment off their seats 1 to $1\frac{1}{2}$ turns to permit starting. Then, readjust them for smooth operation. Set the throttle stop screw with no load connected to unit. Turn throttle lever so it just touches throttle stop screw, then turn throttle stop screw (with throttle lever still touching it) until unit is running at 1500 RPM. Before final adjustment, allow the engine to warm up. Make the idle adjustment under no load. Open the main fuel adjustment until the engine runs smooth under acceleration with no load. Slightly more fuel may be needed (open about $\frac{1}{4}$ turn further) when sudden load is applied, or if operating in very cold weather.

If the engine develops a "hunting" condition (alternate increase and decrease of engine speed), try correcting by opening the main fuel adjustment a little more. Do not open more than $\frac{1}{2}$ turn beyond the maximum power point.

STANDARD TOILET

There is no routine maintenance required on the standard toilet. If a problem occurs, check and make the appropriate correction.

1. PROBLEM:

- Water keeps running into the bowl.

CAUSE:

- The blade in the bottom of the bowl is not closing completely, which in turn keeps the water control valve partially open. The groove into which the blade seats when completely closed is clogged with foreign material. Odors could also leak up into vehicle.

SOLUTION:

- Depress foot pedal to expose blade seal.
- Insert the end of a coat hanger or similar object into the seating groove and remove the foreign material. Avoid damaging the rubber seal while cleaning.

2. PROBLEM:

- Toilet leaks. There is water on the floor.

- Specify the symptom. Determine if water is leaking from:
 - a. The vacuum breaker.
 - b. The water control valve.
 - c. Bowl to mechanism seal (if this is the problem, the water would not stay in the bowl).
 - d. Closet flange base seal.

SOLUTION:

- a. The vacuum breaker—if the vacuum breaker leaks when flushing the toilet, replace the vacuum breaker. (Toilet must be removed.)
- b. If the vacuum breaker leaks when the toilet is not in operation, replace the water control valve.
- c. Leaks at the bowl to mechanism seal—remove mechanism, and replace mechanism seal.
- d. Leaks at closet flange area—check front and rear closet flange nuts for tightness. If leak continues remove the toilet, check the closet flange height. The height should be between 1/4" and 7/16" above the floor. Adjust closet flange height accordingly and replace closet flange seal.

3. PROBLEM:

- Foot pedal operates harder than normal or blade sticks.

SOLUTION:

- Dry blade and apply a light film of Silicone spray to blade.

4. PROBLEM:

- Toilet fails to flush with pedal depressed.

CAUSE:

- Ball valve sheared off due to trying to flush toilet when water is frozen in valve.

SOLUTION:

- Replace ball valve. (Toilet must be removed.)

RECIRCULATING TOILET

Routine maintenance is not required on the recirculating toilet other than recharging which is described in OPERATION OF LIVING AREA FACILITIES section earlier in this manual. If a problem occurs, check and make the appropriate correction.

1. PROBLEM:

- Toilet wobbles.

CAUSE:

- a. Closet retaining nuts not tight.
- b. Mounting brackets not seated to floor.
- c. Closet flange too high.
- d. Mounting surface uneven.

SOLUTION:

- a. & b. Tighten closet retaining nuts.
- c. & d. Check closet flange height by laying straight edge across flange and measuring gap between straight edge and floor at four (4) leg locations (1/4 to 7/16 inch is recommended).

2. PROBLEM:

- Toilet cycles when seat cover is raised.

CAUSE:

- Actuator button protrudes too far from the motor cover.

SOLUTION:

- Alternately press one side of the button, then the other, to work button back further into housing. If button still protrudes too far, replace timer assembly.

3. PROBLEM:

- Toilet does not cycle properly (5 to 9 seconds) when button is pressed.

CAUSE:

- a. Reversed wiring polarity.
- b. Battery run down.
- c. Branch wire too small.
- d. Damaged timer.

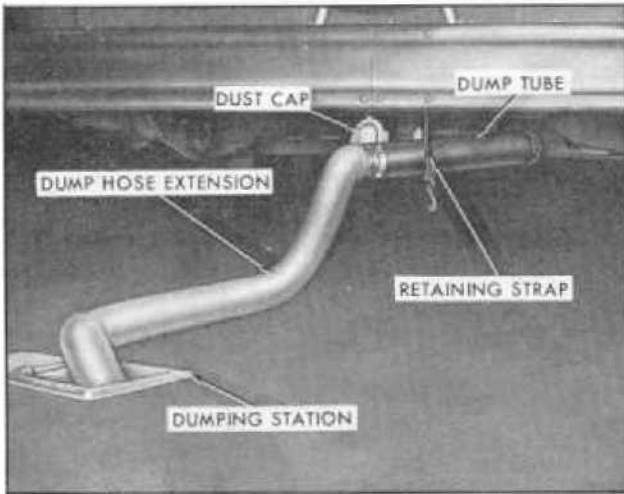

Dumping Station Connection

SOLUTION:

- a. The black wire is positive (hot) and the white wire is negative (ground).
- b. Recharge auxiliary (living area) battery.
- c. Branch wire should be #14 gauge minimum.
- d. Replace timer assembly.

4. PROBLEM:

- Flushing action is weak or noisy.

CAUSE:

- a. Pump is running backwards (reversed wiring polarity).
- b. Cycling unit without enough charge water.
- c. Pump damaged by continuous dry operation.

SOLUTION:

- a. The black wire is positive (hot) and the white wire is negative (ground).
- b. Charge to proper level (3 gallons). Fill to charge level (c) on indicator lens.
- c. Replace pump assembly.

5. PROBLEM:

- Lack of capacity.

CAUSE:

- Too much charge water.

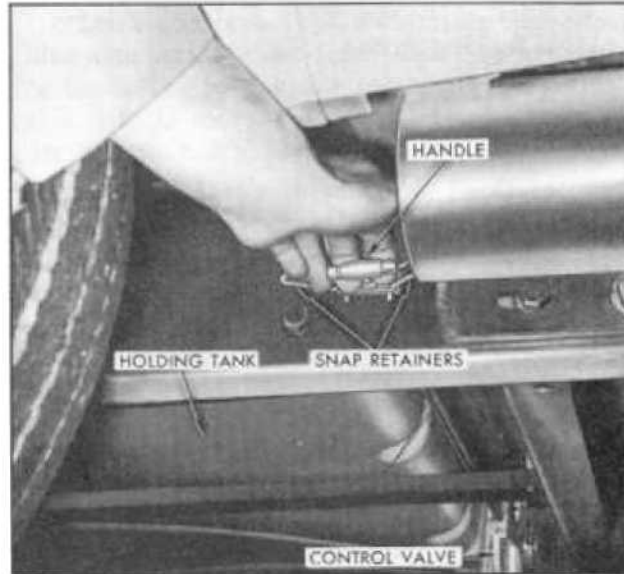

Opening Holding Tank Control Valve

SOLUTION:

- Use three gallons only to charge. Fill to charge level (c) on indicator lens.

DRAINING HOLDING TANK

NOTE: If holding tank is allowed to overflow, the overflow will back up through the bathroom shower drain.

1. Be sure the holding tank valve is closed. It is located on the left-hand side of the vehicle just behind the left rear tandem tire.

2. Remove dump hose extension from the storage tube inside rear bumper.

3. Disconnect dump tube retaining strap mounted to center of rear crossmember. Remove dust cap from pump tube.

4. Join dump tube extension to dump hose by rotating adapter clockwise.

5. Put end of dump hose extension into sanitary dumping station opening. Make sure there are no sags in hose as this would prevent complete dumping.

6. Release two snap retainers at the control valve and pull handle straight out to open. This will drain holding tank completely.

NOTE: If you are using a sewer hook-up in a RV park keep the valve closed until you leave or the holding tank becomes full. This will allow solids to drain more readily.

7. After the holding tank is empty, it is recommended that the control valve be closed and several gallons of water be added to tank



Access to Water Pump and Controls

through the toilet. Then pull handle out to rinse tank. A garden hose may be left running into toilet with valve open to further rinse dump hose and extension.

8. It is advisable to add about 1/2-gallon of water and some non-toxic, non-flammable odor-control type chemical to holding tank.

9. Be sure to push control valve handle back in as far as it will go and re-latch two snap retainers to assure valve will be positively locked while traveling.

10. Restore dump extension to storage tube located inside rear bumper.

DRAINING LIVING AREA WATER SYSTEM

1. Remove the water tank fill cap.
2. Open the holding tank dump valve, after making proper connection to approved dumping station.
3. Turn off water heater at switch located in Living Area Electrical Compartment.

NOTE: To gain access to water compartment remove trim panel and water compartment access door (as shown).

4. Open the water drain valves at the water pump and the water tank, and the two water line drain cocks next to the kitchen sink. To

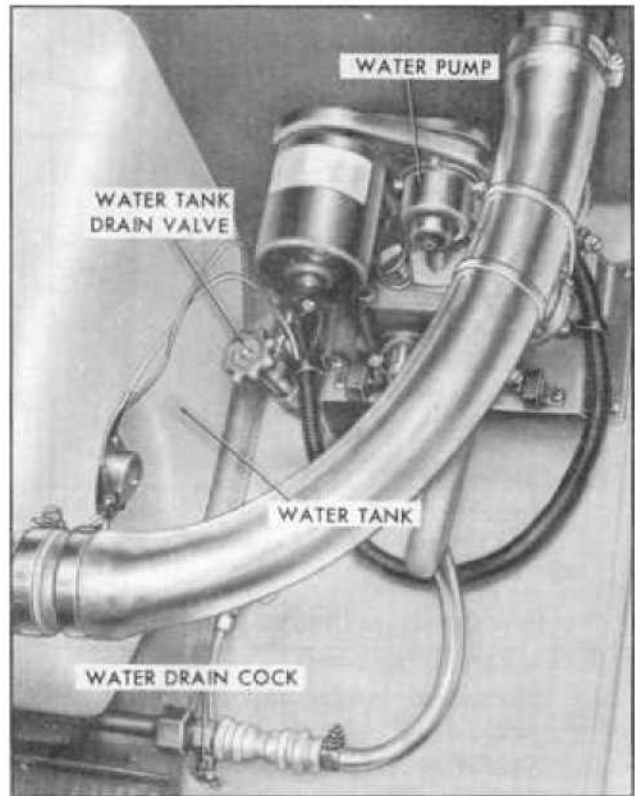

Water Tank Compartment (Typical)

gain access to water line drain cocks for kitchen sink remove the top drawer located to the left of the kitchen sink compartment door. Open the water heater drain valve.

5. Open kitchen and bathroom faucets.

6. Turn on water pump (if not already running).

With the standard toilet, depress the foot pedal until water no longer enters toilet bowl.

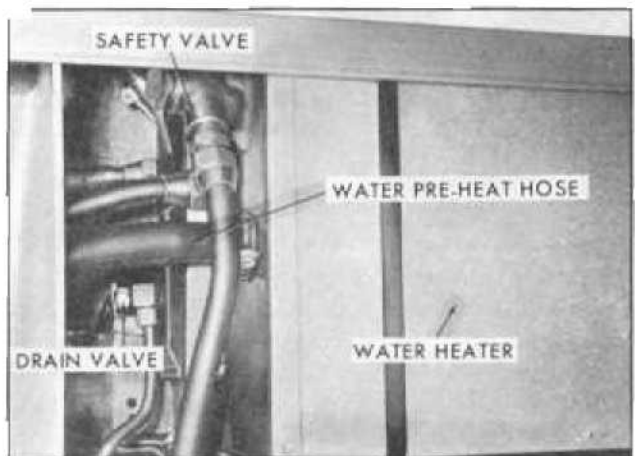

Water Heater



External Water Connection

8. Allow system to drain.
9. Turn off water pump.
10. Disconnect intake and outlet hoses on water pump.
11. With the recirculating toilet, open the toilet water line fill valve and press the flush button.
12. Open shower head shut-off valve and turn the shower on at the bathroom faucet. Extend shower head toward sink to allow the shower head and flexible hose to drain.

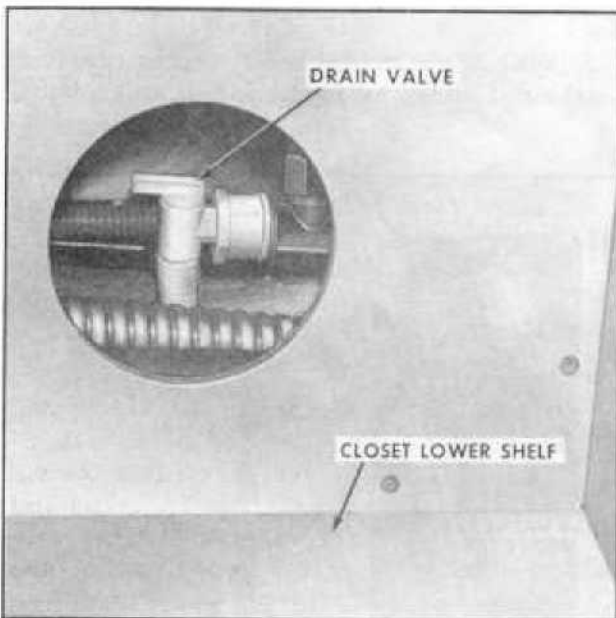

External Water Connection Drain Valve

13. Remove access cover near lower shelf in closet. Open drain valve for external water connection. At the external water connection (inside external utilities compartment), remove hose connection cover. Depress momentarily the button on the check valve to allow this portion of plumbing to drain. Install hose connection cover.

14. Using low pressure (30 psi maximum), blow back through all faucets, forcing water from any low areas.

15. Connect water pump hoses and close all the water line drain cocks and valves including the water heater drain cock. Close kitchen and bathroom faucets, close toilet water line valve (if equipped). Close holding tank dump valve and latch. Stow holding tank tubes and replace dust cap. Replace water tank fill cap.

WATER TANK FILTER

When water flows from the fresh water tank it circulates through the water tank filter before entering the water pump.

The water tank filter, which is located in the water compartment, is transparent and should be checked periodically and cleaned annually.

A helpful sign that filter is dirty is when the transparent filter has become discolored.

Removing filter from water lines

1. Turn water pump and water heater switches to "OFF" position.
2. Drain water tank.

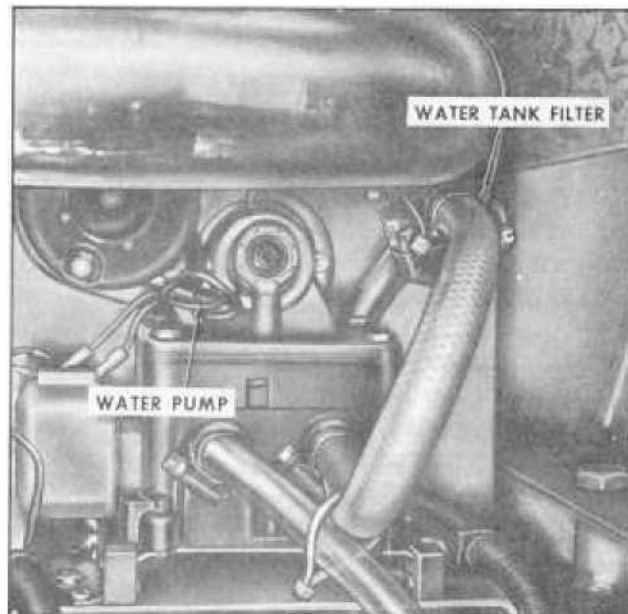

Water Tank Filter Location (Typical)

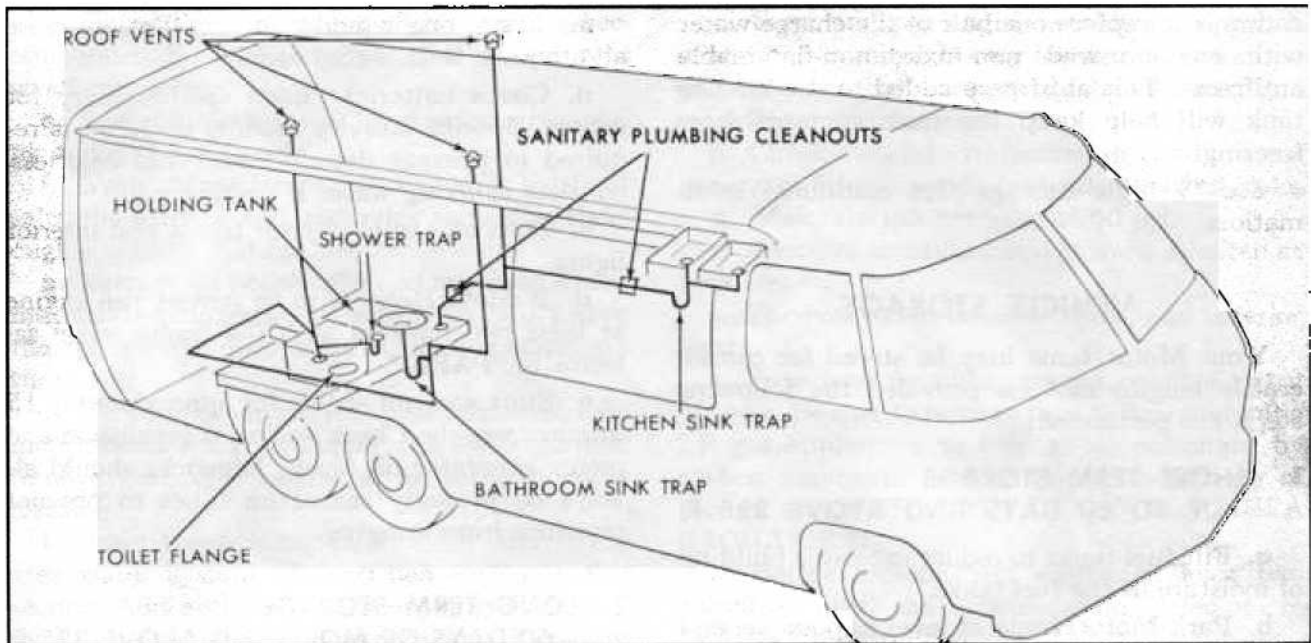

Drainage System (Schematic)

3. Disconnect the two clamps that attach water filter to water line hoses.
4. Separate filter from hoses.

Disassembly of water filter

1. Remove screws which attach filter.
2. Remove filter screen.
3. Clean filter and screen with water and a soft nylon bristle brush.

Assembly of water filter

1. Place filter screen into filter.
2. Assemble filter together with screws.

Assembly of water tank filter to water lines

1. Attach filter to water line hose connections.
2. Tighten hose clamps.
3. Refill water tank.

SANITIZING LIVING AREA WATER SYSTEM

To help assure complete sanitation of your living area water system, it is recommended that the following procedures be followed on a new system, one that has not been used for a period of time, or one that may have become contaminated:

IMPORTANT: Be sure inlet valve to water purifier cartridge is closed while sanitizing living area water system.

1. Prepare a chloride solution using one gallon of water and $\frac{1}{4}$ cup of household bleach (5% sodium hypochlorite solution). Pour one gallon of solution into water tank for each 15 gallons of tank capacity.

2. Complete filling of tank with fresh water. Open each faucet and drain cock until all air has been released from the pipes and entire system is filled.

3. Allow to stand for three hours.

4. Drain and flush with potable (drinkable) fresh water.

5. To remove any excessive chlorine taste or odor which might remain, prepare a solution with one quart of vinegar to five gallons of water and allow this solution to agitate in tank for several days by vehicle motion.

6. Drain tank and again flush with potable water.

WINTERIZATION

When traveling in winter it is recommended that the water tank not be filled until the destination is reached. This will ensure that the vehicle has thoroughly warmed up. The water and holding tank systems should be drained before leaving for home. Also, an approved plastic pipe non-toxic, non-flammable antifreeze should be put in the sink and shower traps. If equipped with a recirculating toilet the standard winterti-

zation is to replace one-half of the charge water with an approved non-toxic, non-flammable antifreeze. This antifreeze added to the holding tank will help keep the tank contents from freezing.

See "Vehicle Storage" for additional information.

VEHICLE STORAGE

Your MotorHome may be stored for considerable lengths of time provided the following steps are performed:

1. SHORT TERM STORAGE

—UP TO 60 DAYS AND ABOVE 32° F.

- a. Fill fuel tanks to reduce excessive build-up of moisture in the fuel tanks.
- b. Park MotorHome as level as possible, end for end and side to side.
- c. Wash MotorHome. If exposed to road salts the exterior and underside should be thoroughly washed and flushed.
- d. Remove all perishables, leave refrigerator door open. Be sure controls are turned off.
- e. Ventilate the living area, drawers, cabinets, closets, etc.
- f. Drain the holding tank, toilet and living area water system as described earlier in this section. Be sure the water pump and water heater are turned off.
- g. Turn off LP gas at tank valve.
- h. Make sure furnace manual valve and thermostat are set at "OFF," range/oven burners at "OFF," oven at "PILOT OFF." If equipped with gas/electric refrigerator be sure gas is turned off at unit's control panel.
- i. Plug or tape all drains to retard evaporation of residual moisture in drain traps.
- j. Tape over vents to prevent insects from entering. Be sure to remove tape before operating LP gas appliances, to help avoid poisoning by carbon monoxide (see caution at beginning of section on OPERATION OF LIVING AREA FACILITIES).
- k. Check MotorHome weekly to ensure that undesirable conditions are not forming (water seepage, mold, odors, etc.). Household air deodorizers or disinfectants in aerosol cans may be used as required, however, do not spray directly on any surface.
- l. Maintain tire pressure of 60 psi.

m. Crack one window for ventilation, close all others as well as roof vents.

n. Check batteries (main and auxiliary for charge. Specific Gravity reading of 1.255 is required to prevent deterioration. Add colorless, odorless drinking water if necessary.

o. Turn off radio, exterior lights, and interior lights.

p. If MotorHome is to be moved, run engine at least two minutes with the transmission selector in "PARK."

q. Start and run engine for approximately 15 minutes weekly. Check engine, transmission and motor generator oil levels. Dipsticks should always be properly seated on tubes to prevent moisture from entering.

2. LONG TERM STORAGE

—60 DAYS OR MORE AND ABOVE 32° F.

- a. Perform all of the above steps except Step q.
- b. MotorHomes without automotive air conditioning; remove spark plugs and squirt each cylinder with "Super Engine Oil Supplement" available at your GMC MotorHome service outlet. Replace spark plugs.
- c. MotorHomes with automotive air conditioning; run engine approximately 15 minutes with automotive air conditioning controls turned to "ON" position. Perform this operation every 30 days.
- d. Treat all bright metal and rubber surfaces with a wax emulsion applied with a brush. A good liquid floor wax or equivalent is satisfactory.
- e. Disconnect batteries, and check Specific Gravity every 30 days. See additional instructions for batteries under "Chassis Electrical System" given earlier in this section.

3. WINTER STORAGE—BELOW 32° F.

- a. While many of the steps in preparing your MotorHome for storage when temperatures go below 32° F. are the same as preparing for storage above 32° F., freezing temperatures present an additional hazard.
- b. Fill fuel tanks to reduce excessive build-up of moisture in the fuel tanks.
- c. Check coolant level and add antifreeze if required, to protect to the lowest expected temperature during storage (at least -20° F.).

d. Change engine oil as shown on the recommended S.A.E. Viscosity Chart to aid cold weather starting.

e. Park MotorHome as level as possible, end for end and side to side.

f. Wash MotorHome. If exposed to road salts, the exterior and underside should be thoroughly washed and flushed.

g. Remove all perishables and anything which may freeze (canned goods, medicine, etc.). Leave the refrigerator door open. Be sure controls are turned off.

h. To ventilate living area, open drawers, cabinets, closets, etc. If equipped with water purifier, remove cartridge assembly to avoid possible freezing.

i. Drain the holding tank, toilet and living area water system as described earlier in this section. Add antifreeze solution (5 gallons non-toxic, non-flammable antifreeze and 5 gallons water) to living area water tank. Open all faucets and turn on water pump. When colored water comes out of the faucets, close faucets. Flush toilet. If equipped with recirculating toilet, charge with antifreeze solution (1½ gallons non-toxic, non-flammable antifreeze and 1½ gallons water). Be sure the water pump and water heater are turned off.

j. Turn off LP gas tank valve.

k. Make sure furnace manual valve and thermostat are set at "OFF," range/oven burners at "OFF," oven at "PILOT OFF." If equipped with gas/electric refrigerator be sure gas is turned off at unit's control panel.

l. Add non-toxic, non-flammable antifreeze (½ cup) to the kitchen, bathroom, and shower drains.

m. Tape over drain openings (except toilet) to prevent evaporation if storage is lengthy (6 months or more).

n. Crack one window for ventilation, close all others as well as roof vents.

o. Start and run engine weekly for approximately 20 minutes. If very low temperatures are expected the batteries should be removed and stored in a warmer area.

p. Check engine transmission and motor generator (if equipped) for evidence of oil leaks.

q. Maintain tire pressure of 60 psi.

r. Remove accumulations of snow as often as possible.

s. Turn off radio, exterior lights, and interior lights.

t. Tape over vents to prevent possible entry of snow. Be sure to remove tape before operating LP gas appliances, to help avoid poisoning by carbon monoxide (see caution at beginning of section on OPERATION OF LIVING AREA FACILITIES).

u. Before moving, run engine at least two minutes with the transmission selector in "PARK" position.

ONAN MOTOR GENERATOR STORAGE

If the motor generator will be out of service for more than 30 days, the following steps should be taken to protect the unit.

1. Run the unit until thoroughly warm.

2. Disconnect fuel supply and run until unit stops.

3. Drain oil from crankcase while still warm. Refill and attach a warning tag stating oil viscosity used.

4. Remove each spark plug. Pour one ounce of rust inhibitor (or S.A.E. 50 oil) into each cylinder. Crank engine several times. Install spark plugs.

5. Service air cleaner.

6. Clean governor linkage and protect by wrapping with a clean cloth.

7. Plug exhaust outlet to prevent entrance of moisture, dirt, bugs, etc.

8. Wipe entire unit with a clean cloth. Coat rustable parts with a light film of grease or oil.

For continuing satisfaction keep your vehicle all GM. General Motors Parts are identified by one of these trademarks:



GMC MOTORHOME NOTES

GENERAL DATA AND SPECIFICATIONS

VEHICLE IDENTIFICATION NUMBER

In order that your vehicle may be specifically identified as to manufacturer, engine type, year designator, etc., refer to chart below.

(TYPICAL IDENTIFICATION NUMBER TZE165V100053)

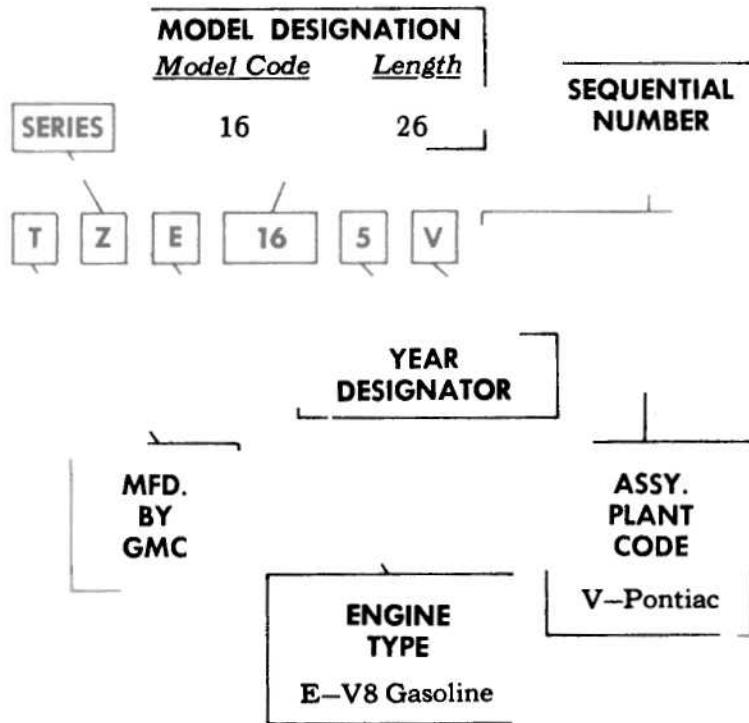

VEHICLE DIMENSIONS

Track	Front - 75.28 in.
	Rear - 82.12 in.
Wheelbase 160 in
Length (Including optional spare tire) 26 ft-9 in
Width 96 in
Height 8 ft-1 in
	With Roof Air Conditioner
Interior Ceiling Height 9 ft-2 in
 76 in

TIRE INFORMATION

SEE "Wheels and Tires" in the SERVICE AND MAINTENANCE section of this manual and the tire placard on the glove box door.

CAPACITIES

Fuel System	Two, 25 Gal. Tanks
Cooling System	23½ Qts.
Engine Oil5 Qts. (Including Filter 6 Qts.)
Turbo Hydramatic	Drain & Refill 4 Qts.
	After Complete Overhaul 12 Qts.
Final Drive (Differential)	4 Pts.
Power Steering Pump	½ Qt.
Power Steering System	1½ Qt.
LP Gas Tank	62.0 Lbs.
Living Area Water Tank	40 Gal.
Holding Tank	32 Gal.
Hot Water Tank	6 Gal.

ENGINE*

Displacement	455 cu. in.
Carburetor	4 Barrel
Compression Ratio	8.5 : 1
Bore	4.125 in.
Stroke	4.250 in.
Firing Order	1-8-4-3-6-5-7-2
Breaker Point Ignition System	
Spark Plugs	ACR45S
Spark Plug Gap0040 in.
Dwell	30°
High Energy Ignition System	
Spark Plugs	ACR46SX
Spark Plug Gap0080 in.
Dwell	Electronic

* See Tune-up label on engine for additional specifications.

BATTERIES

	<u>Type</u>
Main (Automotive) Bat.	E5000 Catalog No. R91
Auxiliary (Living Area) Bat.	Extra Duty Catalog No. 758
	E5000 Catalog No. R91 Rated 3350 Watts @ 0° F
	Extra Duty Catalog No. 758 Rated 4500 Watts @ 0° F

MISCELLANEOUS

Radiator Cap (pressure opening)	9 PSI AC Type RC32
Thermostat	195°F.
Power Converter Output	45 Amps.
Furnace—Forced Air	30,000 BTU
Roof Mounted Air Conditioning	13,500 BTU

FILTER RECOMMENDATIONS

Engine Air Cleaner	AC Type A212CW
Engine Oil	AC Type PF30
Transmission Oil	AC Type PF160
Engine Fuel	AC Type GF441
PCV Valve	AC Type CV697C
Carbon Canister	GM Part 7026014

FRONT END ALIGNMENT

Caster (Degrees)*+2° ±½°
Camber (Degrees)**	R.H.+½° ±¼°
	L.H.+¾° ±¼°
Toe-In (Inches)	0 ±⅛

*L.H. and R.H. must be within ½°.

**L.H. camber must be more positive (+) than R.H. camber

VEHICLE FUSES AND CIRCUIT BREAKERS

The following fuses are located in the fuse block behind the glove box in the dash. Do not use fuses of higher amperage rating than those specified below – or property damage may result.

Usage	Name on Fuse Block	Fuse Type
Auxiliary Battery Switch, Radio, Tape Player	Aux. Bat. - Radio	AGC-10
Heater Controls, Air Conditioner	Htr. - A/C	AGC-25
Side Marker Lights, I.D. & Clearance Lights, Tail Lights, Dome Lights, License Light	Tail - Dome	SFE-20A
Stop Lights, Hazard Warning Lights, Turn Signal Lights	Dir. Sig. - Haz. & Stop	SFE-20A
Windshield Washers	Washer	AGC-10
Cigar-Cigarette Lighter	Ltr.	SFE-20A
Cruise Control, Back-up Lights	Cruise - B/U Lps.	SFE-20A
Transmission Control, Parking Brake Light, Gauges	Gauges - Trans.	SFE-10A
Instrument Lamps	Inst. Lps.	SFE-4A
Warning Tell-Tale Lights	Tell-Tales	AGC-10

VEHICLE FUSES AND CIRCUIT BREAKERS (Con't)

The following circuits employ circuit breakers or have fuses located as indicated:

Headlight Circuit Breaker	.Built Into Light Switch
Heater Blower AGA 30	Built Into Line At .Right Access Door Near Heater Blower
Warning & Signal Flasher GM No. 673499	In Clip Behind Instrument Panel
Vehicle Trouble Light AGC-10	In Line, Behind Access Door, Near Light
Air Suspension Compressor 30A Circuit Breaker	In Fuse Block
Water Pump MDX 6¼	In Line, Near Water Pump

LIVING AREA 12-VOLT SYSTEM FUSES

The following are located in the fuse block in the living area electrical compartment, near the hall closet. Do not use fuses of higher amperage rating than those specified below, or damage may result.

Usage	No. on Fuse Block	Fuse Type
L.H. Front Light Front Roof Vent Fan Galley Light Rear Roof Vent Fan	No. 1	AGC-15
Range Hood Vent Fan and Lights Bath Vent Fan Rear L.H. Reading Light	No. 2	AGC-15
Porch Light Aisle Lights Galley Light Water Pump Systems Monitor	No. 3	AGC-15
Refrigerator Hall Light LPG Compartment Light	No. 4	AGC-15
R.H. Front Light Bath Light Rear R.H. Reading Light	No. 5	AGC-15
Toilet (Recirc.)	No. 6	AGC-15
Furnace Furnace Auxiliary Blower Oven Light Motor Generator Compartment Light	No. 7	AGC-15

ONAN MOTOR GENERATOR (6000 WATT—50 AMP)

Bore 3 ¹ / ₁₆ in.
Stroke 3 in.
Oil Capacity 4 Qt.
	(With Filter Change) 4 ¹ / ₂ Qt.
Spark Plug Type ACR46S
Spark Plug Gap020 in.
Breaker Point Gap020 in.
Ignition Timing (Running or Static) 25° BTDC
Tappet Adjustment (Engine Cold)	
Intake003 in
Exhaust012 in

ONAN MOTOR GENERATOR (4000 WATT—33 AMP)

Bore 3 ¹ / ₈ in.
Stroke 2 ⁵ / ₈ in.
Oil Capacity 3 Qt.
	(With Filter Change) 3 ¹ / ₂ Qt.
Spark Plug Type ACR46S
Spark Plug Gap020 in.
Breaker Point Gap025 in.
Ignition Timing (Cold or Static) 26° BTDC
Tappet Adjustment (Engine Cold)	
Intake003 in
Exhaust010 in

LIGHT BULB SPECIFICATIONS (INSTRUMENT PANEL)

Usage	Quantity	Bulb. No.
Brake System Tell Tale		161
Generator Tell Tale		161
Park Brake Tell Tale		74
Cruise Control Tell Tale		74
Door Ajar Tell Tale		74
Low Fuel Tell Tale		74
Low Air Tell Tale	1	74
Power Level Tell Tale	2	74
High Beam Indicator	1	161
Turn Signal Indicator	2	168
Instrument Cluster Lights	2	194
Speedo Cluster Lights	2	194
Dome Lights	2	211
Radio Dial (AM/FM/Stereo/Tape)	1	566
Radio Dial (Exc. AM/FM/Stereo/Tape)	1	1893
Heater Control	1	1895

LIGHT BULB SPECIFICATIONS (EXTERIOR)

<u>Usage</u>	<u>Quantity</u>	<u>Bulb No.</u>
Clearance and I.D.	10	67
License	1	67
Side Markers—Front	2	194
Side Markers—Rear	2	194
Back-Up Lights	2	1156
Parking and Turn Signals	2	1157
Stop and Tail	2	1157
Headlights	2	6014

LIGHT BULB SPECIFICATIONS (LIVING AREA)

<u>Usage</u>	<u>Quantity</u>	<u>Bulb. No.</u>
R.H. Front Light	2	1141
L.H. Front Light	2	1141
Kitchen Light	2	1141
Hall Light	2	1141
Porch Light	1	1141
Compartment Lights	2	1141
Range Hood Lights	2	1156
Rear Compartment Reading Lights	2	1383
Bathroom Lights	6	1141
Aisle Lights	2	67

120-VOLT SYSTEM CURRENT RATING

Water Heater	8.7 Amp.
Power Converter	6.8 Amp.
Refrigerator8 Amp.
Roof Mount Air Conditioner	15.0 Amp.
Vacuum Cleaner	7.0 Amp.

12-VOLT LIVING AREA COMPONENTS CURRENT RATING

R.H. Front Light	2.88 Amp.
L.H. Front Light	2.88 Amp.
Hall Light	2.88 Amp.
Rear R.H. Reading Light	1.50 Amp.
Rear L.H. Reading Light	1.50 Amp.
Kitchen Light	2.88 Amp.
Aisle Lights (Per Light)59 Amp.
Porch Light	1.44 Amp.
Bath Room Lights	8.64 Amp.
Range Hood Vent Fan and Light	6.70 Amp.
Furnace Blower	6.8 Amp.

12-VOLT LIVING AREA COMPONENTS CURRENT RATINGS (CON'T)

Water Pump 3.6 Amp.
Refrigerator 6.0 Amp.
Recirculating Toilet 7.0 Amp.
Monitor Panel 2.5 Amp.
Front Vent Fan	3.50 Amp.
Rear Vent Fan	3.50 Amp.
Bath Vent Fan	3.50 Amp.
Oven Lamp	1.44 Amp.
Furnace Auxiliary Blower	3.00 Amp.
Motor Generator Compartment Lamp	1.44 Amp.
LPG Compartment Lamp	1.44 Amp.

For continuing satisfaction keep your vehicle all
GM. General Motors Parts are identified by one
of these trademarks:



GMC MOTORHOME NOTES

OWNER ASSISTANCE

The satisfaction and goodwill of the owners of GMC Truck & Coach products are of primary concern to your dealer and the GMC Truck & Coach Division. Normally, any problems that arise in connection with the sales transaction or the operation of your vehicle will be handled by your dealer's Sales or Service Departments. It is recognized, however, that despite the best intentions of everyone concerned, misunderstandings will sometimes occur. If you have a problem that has not been handled to your satisfaction through normal channels, we suggest that you take the following steps:

STEP ONE—Discuss your problem with a member of dealership management. Frequently, complaints are the result of a breakdown in communications and can quickly be resolved by a member of the dealership management. If the problem already has been reviewed with the Sales Manager or Service Manager, contact the Dealer himself or the General Manager.

STEP TWO—Contact the GMC Truck & Coach Division Zone Office closest to you listed on page 105 (or in Canada contact the General Motors Zone Office). When it appears that your problem cannot be readily resolved by the service outlet without additional assistance, the matter should be called to the attention of the Zone's Customer Services Department and the following information provided:

- Your name, address, telephone number
- Vehicle Identification Number*
- Dealer's name and location
- Vehicle's delivery date and mileage
- Nature of problem

STEP THREE—Contact the Customer Services Manager, GMC Truck & Coach Division, 660 South Blvd. East, Pontiac, Michigan 48053 (phone 313-857-4547). In Canada, contact the Owner Relations Manager, General Motors of Canada Limited, Oshawa, Ontario (phone 416-644-6624). If after an additional review of all facts involved he feels that some further action can be taken, he will so instruct the Zone. In any case, your letter will be acknowledged providing GMC Truck & Coach Division's position in the matter.

When contacting the Zone or Home Office, please bear in mind that ultimately your problem likely will be resolved in the dealership utilizing the dealer's facilities, equipment and personnel. It is suggested, therefore, that you follow the above steps in sequence when pursuing a problem.

Your purchase of a GMC Truck & Coach product is greatly appreciated by both your dealer and GMC Truck & Coach Division. It is our sincere desire to assist you in any way possible to assure your complete satisfaction with your vehicle.

*Available from vehicle registration, title or vehicle identification plate

U.S. ZONE TERRITORIES

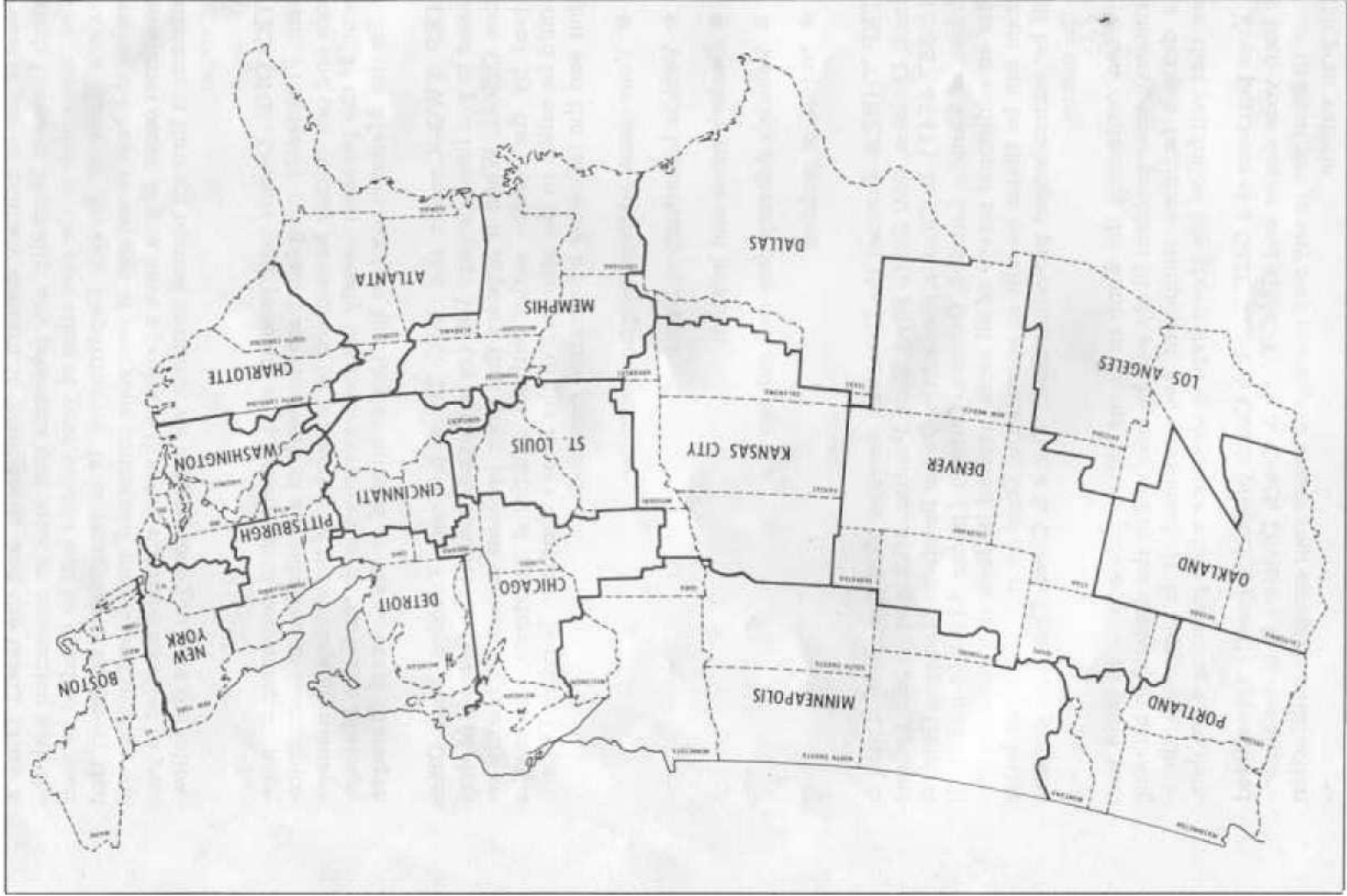

U.S. ZONE OFFICES

When calling for assistance, please ask for Customer Services Manager

ATLANTA

5373 Peachtree Industrial Blvd.
Chamblee, Georgia 30341
455-5564
Area Code 404

BOSTON

20 Cross St.
Woburn, Mass. 01801
935-6858
Area Code 617

CHARLOTTE

1914 W. Morehead
P.O. Box 8149
Freedom Station
Charlotte, N. C. 28208
332-4181-82-83
Area Code 704

CHICAGO

2021 Spring Rd.
Oakbrook, Ill. 60521
654-6465
Area Code 312

CINCINNATI

4010 Executive Park Drive
Suite 320
Cincinnati, Ohio 45241

DALLAS

6007 Peeler Street
P.O. Box 35187
Airlawn Station
Dallas, Texas 75235
358-5316
Area Code 214

DENVER

4715 Colorado Blvd.
Denver, Colo. 80216
388-1611
Area Code 303

DETROIT

600 S. Saginaw
P.O. Box 456
Pontiac, Mich. 48053
857-4686
Area Code 313

KANSAS CITY

1509 N.E. Parvin Rd.
Kansas City, Mo. 64116
281-6063
Area Code 913

LOS ANGELES

8155 Van Nuys Blvd.
Suite 1030 Panorama Towers
Panorama City, Calif. 91402
873-7554
Area Code 213

MEMPHIS

3495 Lamar Ave.
Box 18714
Holiday City Sta.
Memphis, Tenn. 38118
365-9210
Area Code 901

MINNEAPOLIS

3001 Broadway N.E.
Minneapolis, Minn. 55413
331-4282
Area Code 612

NEW YORK

780 Dowd Avenue
Elizabeth, N.J. 07207
354-8200
Area Code 201

OAKLAND

10626 E. 14th Street
Oakland, Calif. 94603
568-6929
Area Code 415

PITTSBURGH

Russelton Road
Cheswick, Pa. 15024
274-8000
Area Code 412

PORTLAND

5355 S.W. Western Avenue
Beaverton, Ore. 97005
646-8333
Area Code 503

ST. LOUIS

Suite 320
Crestwood Executive Center
St. Louis, Mo. 63126
849-0990
Area Code 314

WASHINGTON

Suite 410—Profess. Bldg.
1109 Spring St.
Silver Spring, Md. 20910
659-3166
Area Code 202

HAWAII (HONOLULU)

1600 Kapiolani Blvd.
Suite 714
946-3988
Honolulu, Hawaii 96814
Area Code 808

Note: The State of Alaska is serviced by the Portland Zone.

MEXICO ZONE OFFICE

General Motors de Mexico S.A. de C.V. Av. Ejercito Nacional No. 843 Mexico 5, D.F.
Phone No. 545-3921

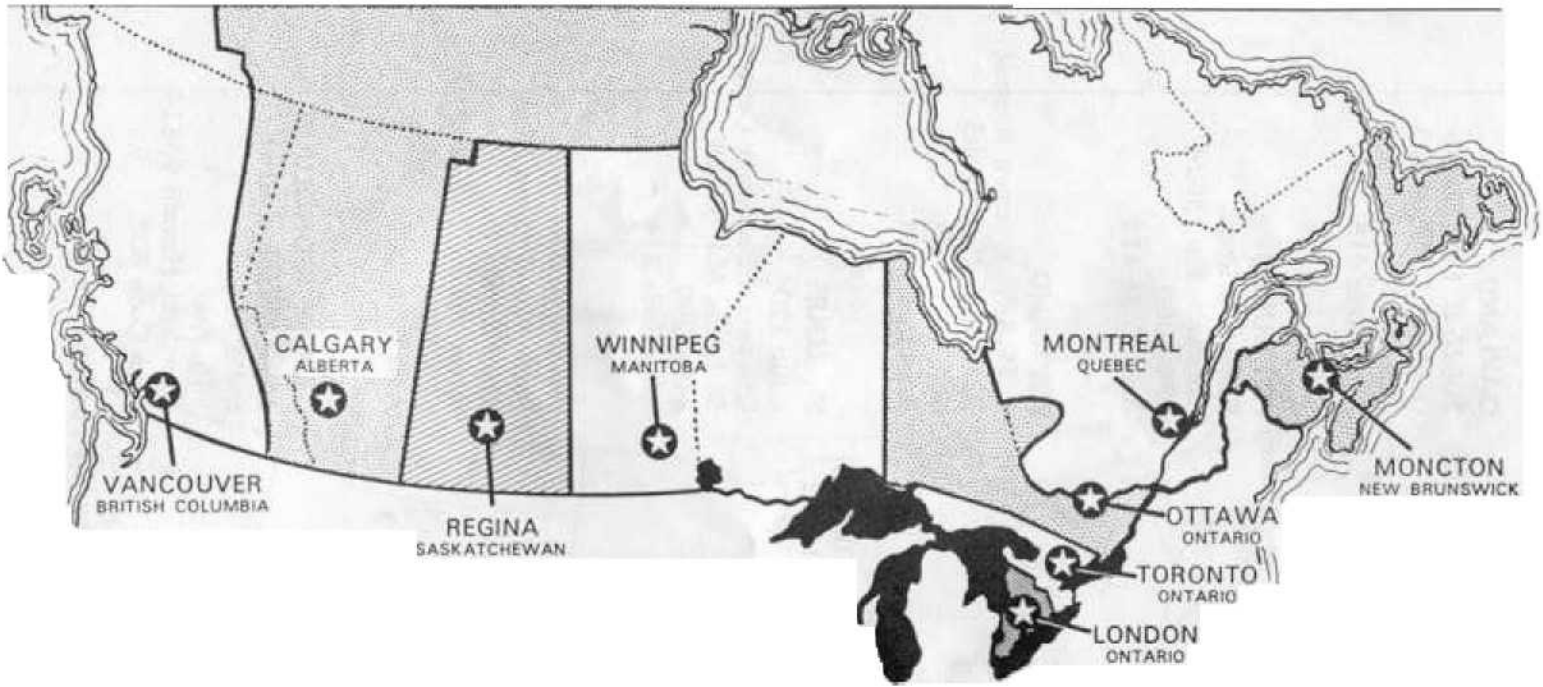

GM OF CANADA LIMITED—ZONE OFFICES

ZONES	ADDRESS	AREA CODE	PHONE NO.
VANCOUVER	900 Terminal Avenue Vancouver, B.C. V6A 2N6	604	684-9444
CALGARY	Box 2510 Calgary, Alberta T2P 2M7	403	243-4621
REGINA	581 Park Street Regina, Sask. S4P 3E9	306	643-2224
WINNIPEG	1345 Redwood Avenue Winnipeg, Man. R2X 0Y9	204	633-1080
LONDON	1991 Oxford St. E. London, Ontario N6A 4P6	519	455-2400

ZONES	ADDRESS	AREA CODE	PHONE NO.
TORONTO	1200 Eglinton Ave. East Don Mills, Ont. M3C 1J1	416	446-5053
OTTAWA	875 Belfast Road Ottawa, Ont. K1G 0Z4	613	237-5051
MONTREAL	5000 Trans-Canada Hwy. Pointe Claire, Quebec H9R 4R2	514	697-9160
MONCTON	653 St. George Street Moncton, N.B. E1C 8M2	506	854-1500

AFTER-HOUR INFORMATION SERVICE

If you have attempted to contact a GMC MotorHome dealer after normal business hours, without success, you may call the toll-free number below. The operator who will answer has a list of private numbers through which many dealers can be reached after hours and will give you the number and location of the nearest one.

800-521-2806

In Michigan call: 800-572-7959

It should be understood, however, that any charges for after-hours service assistance must be borne by the owner. In those instances where the repair qualifies under our published warranty, the dealership charge for additional services, such as for, after normal business hour repairs will be the owner's expense.

MAINTENANCE MANUAL AND PARTS BOOK

Maintenance Manual and/or Parts Book can be purchased through any GMC MotorHome dealer.

IMPORTANT FACTS YOU SHOULD KNOW ABOUT GASOLINE MILEAGE AND HOW TO IMPROVE IT

How you drive, where you drive, and when you drive all have an effect on how many miles you can get from a gallon of gasoline. The careful attention you give your vehicle as far as maintenance and repairs are concerned will also contribute importantly to fuel economy.

FUEL SELECTION

Use an unleaded gasoline of at least 91 Research Octane—Symbol Number 2. Additional details on Fuel Requirements are given in the SERVICE AND MAINTENANCE section.

“JACKRABBIT” STARTS

Gasoline can be conserved (and engine and tire life prolonged) by avoiding unnecessarily rapid acceleration away from lights and stop signs.

STOP-AND START DRIVING

Frequent stops and starts during a trip really cut down on your miles per gallon. Plan even your short trips to take advantage of through streets to avoid traffic lights. Pace your driving like the professional drivers to avoid unnecessary stops.

EXCESSIVE IDLING

An idling engine uses gasoline, too. If you're faced with more than a few minutes wait and you're not in traffic, it may be better to “turn off” and start again later.

SUDDEN STOPS

Sudden stops themselves don't waste gasoline, but energy is wasted as heat in braking. Energy in the form of gasoline is also needed to accelerate back to driving speed.

LUBRICANTS

A properly lubricated vehicle means less friction between moving parts. Consult this manual and the maintenance schedule for the proper lubricants to use and the lubrication intervals.

AIR CLEANER

Your vehicle receives its power from a mixture of gasoline and air. The air is taken into the system through the air cleaner so it's important to replace the air cleaner at required intervals. A dirty air cleaner reduces engine efficiency.

PROPERLY TUNED ENGINE

Overall tuning (a check on timing, distributor points, spark plugs, emission control devices, etc.) can improve your vehicle's gas mileage. You just can't expect an “out-of-tune” engine to give you good gas mileage and cleaner air.

EXCESS WEIGHT

Fuel economy is related to the work the engine must do. The heavier the load, the more power it takes. Keep excess weight to a minimum by removing any personal effects or luggage from the vehicle when they are not needed.

TIRE INFLATION

Underinflation not only causes needless wear of the tires, but can also waste gasoline. It's a good idea to check tire pressures regularly.

WHEEL ALIGNMENT

“Toe in” or “toe out” has the effect of dragging your front tires sideways and causes premature tire wear. It takes power to carry this extra load and that takes gas from your tanks.

INDEX

SUBJECT	PAGE NO.	SUBJECT	PAGE NO.
A			
Absorbers, Shock	78, 79	Brakes	
Accessory Position, Ignition Switch	12	Linings	17
Adjusters, Automatic Brake	17	Master Cylinder Level	69
After-Hour Information Service	107	Parking Brake	17
Air Circulation	22, 23, 44	Power	16
Air Cleaner	73	Self Adjusting	17
Air Compressor	79	Trailer	7
Air Conditioning		Warning Light	19
Automotive	23	Break-In Period	
Roof Mount	45	New Vehicle	9
Air Inlets, Ventilation	22, 23	Vehicle Pulling Trailer	7
Air Suspension	79	Bright Metal Cleaning	60
Alignment, Wheel	97	B.T.U. Ratings	96
Antenna	24	Bulbs and Fuses	97, 98, 99, 100
Anti-theft Steering Column Lock	12	Bumpers—Energy Absorbing	2
Appearance Care	57	Bunk Beds	49
Automatic Transmission		C	
Fluid Check	67	Cap, Filler	
Fluid Recommendations	67	Engine Oil	62
Maintenance	67, 68	Gasoline	72
Operation	13	Living Area Water Tank	33, 89
Starter Safety Switch	12	Power Steering Reservoir	68
Auxiliary Battery	22	Radiator	69, 70
Auxiliary Fuel Tank	22	Capacities	96
Axle, Final Drive	68	Carbon Monoxide Caution	11, 29
B			
Bathroom		Carburetor, Engine	72
Drains	91	Air Cleaner	73
Roof Fan	44	Carpet Care	57
Roof Vent	43	Changing Wheels & Tires	53, 54, 75 - 78
Shower	43	Charging System Indicator Light	19
Sink	42	Chassis Lubrication	66
Toilets	41, 42	Check List	3
Warm Air Duct	43	Child Restraints	6
Batteries		Chrome Protection	60
Emergency Starting	51	Cigar Lighter	22
Fluid Level	73	Circuit Breaker, Headlights	18
Gas Caution	73	Circuit Breaker Panel	29, 81
Location	73	Cleaning	
Battery Boost Switch	21	Carpet Care	57
Battery Charger, Power Converter	29	Exterior Finish and Trim	60
Bearings, Rear Wheel	78	Fabric and Interior Trim	57
Beds	48 - 50	Spot Removal	59
Before Driving Your MotorHome	3	Vacuum Cleaner	57
Belts, Lap	5, 6, 57	Cold Weather Starting	13
Blower, Ventilating	22, 23	Compartment	
Body Identification Number	95	Engine	63
		External Utilities	61
		Front Access	62
		Glove	4

SUBJECT	PAGE NO.	SUBJECT	PAGE NO.
Living Area Water	89	Emergency Equipment	8
L.P. Gas	80	Emergency Exit	55
Complaint Procedure	103	Emergency, In Case Of	51
Conditioner, Air		Brake System Warning Light	19
Automotive	23	Charging System Warning Light ...	19
Roof Mounted	45	Emergency Starting	51
Converter, Power	29	Hazard Warning Flasher	51
Converting Davo to Beds	49	Jacking Instructions	53
Converting Dinette to Bed	48	Jump Starting	51
Converting Side Facing Settee to Bed ...	49	Overheated Engine	53
Cooling System		Power Level System	26
Care	70	Pushing to Start	51
Coolant Recommendation	69	Towing	54
Overheating Caution	53	Energizer (See Batteries)	73
Cruise Control	15	Energy Absorber—Bumper	2
Customer Service	103	Engine Access	62
		Engine Coolant Tank	69
D		Engine Compartment	63
Davo	49	Engine Firing Order	96
Defrosters	22-24	Engine Oil	
Differential, Final Drive	68	Capacity	96
Dimensions, Vehicle	95	Change Interval	65
Dimmer Switch, Headlamp	18	Dip Stick	67
Dinette	48	Filter	65
Directional Signal	44	Pressure Gauge	19
Distributor	73	Recommendation	65
Dome Lights	21	Entrance Door	5
Drainage System	91	Ethylene Glycol Coolant	70
Draining Holding Tank	88	Exhaust Gas Caution	11
Draining Living Area Water System	89	Exhaust System Maintenance	79
Drain Traps	91	Parked with Engine Running	11
Driver Check List	3	Exhaust System	79
Driver's Seat	4	Exit, Emergency	55
Driving Tips	9	Exterior Finish Care	60
Dump Hose	88	External Power Connection	30
Dump Valve	88	External Utilities Compartment	30
Dusty Condition, Operation Under	32, 73	External Water Connection	34
E		F	
Electrical Systems		Fabric Care	58
Batteries	21, 29, 73	Filling L.P. Gas Tank	80
Battery Boost Switch	21	Filling Living Area Water Tank	33
Battery Charger, Power Converter ..	29	Filter, Water Tank	90
Bulbs, Light	99, 100	Filters	97
Charging System Indicator Light ...	19	Final Drive Differential	68
Converter, Power	29	Finish Care, Exterior	60
Diode Assembly	21	Fire Extinguisher	56
External Power	30	Flammable Cleaning Solvents	58
Lighting System	30	Flashers	
Living Area Elec. Compartment ..	29, 81	Hazard Warning	51
Living Area Fuse Block	81, 98	Turn Signal	14
Motor Generator	31, 81	Flooded Engine	13

SUBJECT	PAGE NO.	SUBJECT	PAGE NO
Floor Controls	16	Holding Tank	88
Fluid Capacities	96	Winter Travel	91
Fluid Levels		Horn	14
Batteries	73		
Brake Master Cylinder	69	Identification Lights	21
Engine Oil	65	Identification Number, Vehicle	95
Final Drive	68	Identification Plate, Vehicle ..	2
Power Steering	68	Ignition, Keys and Lock	4, 12
Radiator	70	Ignition Timing	96
Transmission	67	In Case of Emergency	51
Foreign Countries, Operation in ...	7	Indicator Lights	20
Four Way Hazard Warning Flasher	51	Infant Restraining Methods .	6
Front Access Doors	62	Inflation Pressure, Tire	75
Front Suspension	78	Instrument Panel	19
Fuel		Interior Appearance Care ...	57
Filler Cap Location .	72		
Gauge	19	J	
Motor Generator ..	32	Jack Usage Instructions	53
Recommendations .	71	Jump Starting	51
Tank Selector Switch	21		
Fumes, Engine Exhaust ..	11	K	
Furnace	45	Keys	4
Furniture	48	Kitchen Facilities	36
Fuses		Power Range Hood	37
Living Area Chart ..	98	Range/Oven	37
Living Area Location	81	Refrigerator	36
Vehicle Chart	97	Sink	40
Vehicle Location ...	74	Knocking Engine	71
G			
Gas, L.P.	80	L	
Gas Station Information ... Inside Back Cover		Lane Change and Turn Signal	14
Gasoline (See Fuel)	71	Lap Belts	5
Generator Indicator Light	19	Latch, Door	5
Generator, Motor	31	Leveling Vehicle	26
General Data & Specifications	95	Lighter, Cigar	26
Glass and Mirrors	57	Lights	
Glove Box	4	Aisle	31, 100
Gross Vehicle Weight (GVW)	2	Brake Warning 19
H		Bright Beam Indicator 18
Hazard Warning Flasher	51	Bulb Chart	99, 100
Headlight		Charging System 19
Adjustment	74	Dome 21
Flicker	18	Hazard Flasher 51
High Beam Dimmer Switch	18	Headlight Aim 74
High Beam Indicator	18	Headlight Circuit Breaker	.. 18
Replacement	74	Headlight Switch 21
Switch	21	Living Area 30
Heater, Operation	22	Marker & Clearance 21
Hitches, Trailer	6	Parking Brake 17
Hoisting Vehicle	64		

SUBJECT	PAGE NO.	SUBJECT	PAGE NO.
Porch	31	P	
Tail Lights	21	Paint, Care and Touch Up	60
Tell Tale Warning	20	Parking	12
Turn Signal Indicator	19	Brake	17
Linings, Brake	17	Lights	21
Living Area Electrical Compartment	29	Pilot Lights	
Living Area Electrical System	29	Oven	37
Living Area Facilities Caution	29	Range	37
Living Area Lighting	30	Plugs, Spark	73
Loading, Vehicle	1	Points, Distributor	73,96
Locks	5	Polishing and Waxing	60
Low Lead Fuels	71	Porch Light	31
Low Temperature Operation	13	Power	
L.P. Gas System	80	Brakes	16
Lubrication		Converter and Battery Charger	29
Details	65	Level System	26
M		Vents	44
Maintenance		Steering	14
Appearance Care	57	Pressure, Tire Inflation	75
Manual	107	R	
Schedule	61	Radiator and Coolant	69
Master Cylinder, Brake	67	Radio	
Marker Lights	21	AM	24
Metal Cleaners	39,60	AM/FM	24
Methods of Restraining Children	6	Antenna	24
Mirrors, Rear View	3	Mobile Transmitter	25
Mobile Radio Transmitter	25	Stereo	25
Monitor Panel	31	Tape System	25
Motor Generator	31,81	Raising Vehicle With Jack	53
N		Range Hood	37
New MotorHome Break-In	7	Range/Oven	37
O		Rear Suspension	79
Odometer	19	Rear Wheel Bearings	78
Oil		Recirculating Toilet	42,87
Additives	65	Refilling	
Checking Engine Oil Level	65	L.P. Gas Tank	80
Filter	65	Water Tank	33
Motor Generator	84	Refrigerator	36
Pressure Gauge	19	Restraints, Child	6
Recommendations	65	Roof	
Transmission	67	Mounted Air Conditioning	45
Viscosity	65	Vents	44
Onan Motor Generator	31,81,93	Rotation, Tire	77
Operation in Foreign Countries	7	S	
Oven Operation	37	Safety	
Overheated Engine		Belts, Lap	5
Temperature Gauge	19	Sanitizing Water System	91
What To Do	19	Schedule	
Owner Assistance	103	Break-In	7
		Maintenance	61

SUBJECT	PAGE NO.	SUBJECT	PAGE NO.
Schematics	33, 82, 83	Short Term 92
Seat		Winter 91
Adjustments	. 4	Suspension	
Belts	. 5, 6	Front 78
Self Adjusting Brakes	. 17	Rear 79
Service and Maintenance	. 61	Swivel Seats 49
Service Information, After-Hour	. 107		
Settee	. 49	T	
Sewer Connection	. 88	Tape System, Stereo 25
Shock Absorbers	78, 79	Tell Tale Lights 20
Shower	. 43	Temperature	
Signals, Turn	. 14	Control, Cooling and Heating 22
Sinks		Gauge 19
Bathroom	. 42	Thermostat	
Kitchen	. 40	Engine Cooling 96
Solvents, Recommended Cleaning	. 57	Living Area Furnace 45
Spark Knock	. 71	Tilt Steering Wheel 15
Spark Plugs	73, 96	Tips	
Speakers, Radio	24, 25	Driving 9
Specifications		Trip 8
Air Cleaner 97	Water Saving 42
Alignment, Front End 97	Tire	
Amperes	100, 101	Care 75
Batteries 96	Changing	53, 54
Body 95	Inflation Pressure 75
Capacities 96	Inspection 77
Dimensions 95	Load Limit 75
Filters 97	Replacement 76
Fuses	. 97, 98	Rotation 77
Light Bulbs	99, 100	Snow 77
Miscellaneous 96	Traction 76
Motor Generator 99	Tread Wear 76
PCV Valve 97	Toilet	
Spark Plugs, Engine 96	Standard 41, 86
Vehicle Identification 95	Recirculating 42, 87
Speedometer and Odometer 19	Towing 54
Spot Cleaner 57	Trailer Hauling 6
Stains, Removal Of 59	Transmission	
Starting Engine 12	Braking Effect On Hills 12
Cold Weather 13	Checking Fluid Level 67
Emergency 51	Maintenance 67
Steering		Shift Controls 13
Column Controls 12	Transmitter, Mobile Radio 25
Linkage 69	Tread Wear Indicators 76
Maintenance 68	Trim Care Interior 57
Power 14	Turn Signals 14
Tilt 15		
Wheel 12	U	
Stereo, Radio and Tape 25	Under Coating 60
Storage of MotorHome		Upholstery and Carpet 57
Long Term 92		
Motor Generator 93		

SUBJECT	PAGE NO	SUBJECT	PAGE NO.
V			
Vacuum Cleaner	57	System	33, 89, 91
Vehicle Identification	2, 95	Tank	33, 34, 96
Vehicle Storage		Waxing	60
Long Term	92	Weight Distribution	1
Short Term	92	Wheel Alignment ..	97
Winter	92	Wheel Bearings	
Ventilation	44	Front	78
Vents	44	Rear	78
Volatile Cleaning Solvents, Caution	58	Wheel Changing ..	76
W			
Warning Flasher, Hazard	51	Wheel, Tilt Steering	15
Warning Lights		Windows	44
Brake	19	Windshield	
Charging System ..	19	Defrosting ...	22, 23
Cluster	20	Washers 21
Low Fuel	20	Wipers 21
Washers, Windshield	21	Winterization 91
Washing	60	Wiring Diagrams ..	82, 83
Water		Wrecker, Towing 54
External Connection	34	Z	
Filter	90	Zone Offices	
Heater	35, 100	Canada	106
Pump	34, 98	Mexico	105
		United States	105
		Zone Territories	
		Canada	106
		United States	104

GMC MOTORHOME NOTES



GMC MOTORHOME NOTES

2001436