

GMC

1977

Motorhome

OPERATING

MANUAL

(WITH 403 CUBIC INCH ENGINE)

IMPORTANT
OPERATING,
SAFETY AND
MAINTENANCE
INSTRUCTIONS

GMC

GM

A Word To The GMC Motorhome Owner...

Congratulations on your purchase of a GMC Motorhome. You have opened the way to an endless variety of happy holidays.

This manual has been prepared to acquaint you with the operation and maintenance of your Motorhome, and to provide important safety information. It is supplemented by convenient folders which provide additional information on vehicle maintenance and warranties. We urge you to read these publications carefully and follow the recommendations to help assure the most enjoyable and troublefree operation of your vehicle.

When it comes to service, remember that your GMC Motorhome Dealer knows your vehicle best and is interested in your complete satisfaction. Return to him for service and any other assistance you may require.

GMC Truck and Coach maintains a number of Zone Offices throughout the country. Should you have a problem that cannot be handled through normal channels, please follow the procedure described under the "Owner Assistance" section.

Thank you for choosing a GMC Motorhome. We extend our best wishes for many years of pleasant traveling.

Cordially,

James E. Conlan
General Sales Manager

GMC MOTORHOME OPERATING MANUAL

IMPORTANT

This manual should be considered a permanent part of the vehicle and must remain with the vehicle at time of resale.

All information, illustrations and specifications contained in this manual are based on the latest product information available at the time of publication. The right is reserved to make changes at any time without notice.

For vehicles sold in Canada, substitute the name General Motors of Canada Limited whenever the name GMC Truck & Coach Division appears in this manual.

Service Publications

**GMC TRUCK & COACH DIVISION
GENERAL MOTORS CORPORATION
Pontiac, Michigan 48053**

TABLE OF CONTENTS

SUBJECT	PAGE NO.	SUBJECT	PAGE NO.
<u>Important Information on</u>			
<u>Vehicle Loading</u>	1	Headlight Dimmer Switch	22
<u>Before Driving Your MotorHome</u>	5	Headlight "Flicker"	22
Driver Checklist	5	Instrument Panel and Controls	22
Inside Rearview Mirror	5	Speedometer and Odometer	22
Outside Rearview Mirror	6	Fuel Gauge	22
Keys	6	Temperature Gauge	22
Entrance Door	6	Oil Pressure Gauge	23
Seats	7	Charging System Warning Light	23
Belt Restraints	9	Brake System Warning Light	24
Restraint of Pregnant Women	10	Tell-Tale Warning Light Cluster	24
Lap Belt Inspection	10	Voltmeter	25
Child Restraint	11	Headlight Switch	25
Trailer Hauling	11	Windshield Wiper Lever	25
Operation In Foreign Countries	12	Windshield Washers	25
Trip Tips	12	Fuel Selector Switch	26
Driving Tips	13	Battery Boost Switch	26
<u>Starting and Operating Vehicle</u>	15	Cigar-Cigarette Lighter	26
Engine Exhaust Gas Caution	15	Automotive Heating and Air Conditioning	26
Steering Column Controls	16	Radios and Tape Deck	27
Anti-Theft Steering Column Lock	16	Mobile Radio Transmitters	31
Theft Protection	16	Standard Rear Suspension System	31
Parking	17	Electro-Level System	32
Starting Engine	17	<u>Operation of Living Area Facilities</u>	35
Automatic Transmission	18	Living Area Facilities Caution	35
Turn Signal and Lane Change Feature	19	Living Area Electrical System	35
Hazard Warning Flasher	19	General Information	35
Horn Control	19	120-Volt To 12-Volt Converter and Battery Charger	36
Power Steering	19	External Power	36
Tilt Steering Wheel	19	Lighting System	37
Cruise Control	19	Monitor Panel	37
Floor Controls	21	Motor Generator	38
Power Brake System	21		

TABLE OF CONTENTS

SUBJECT	PAGE NO.	SUBJECT	PAGE NO.
Exterior Receptacle	39	Freeing Vehicle From Sand, Etc.	66
Living Area Water System	40	Emergency Exit	67
Filling Water Tank	40	Fire Extinguisher	67
External Water Connection	40	<u>Appearance Care</u>	69
Water Pump	42	Care and Cleaning of Interior	69
Water Heater	42	General Information	69
Kitchen Facilities	43	Kitchen Sink	69
All-Electric Refrigerator	43	Vacuum Cleaner	69
Kitchen Range/Oven	44	Drapery Care	70
Kitchen Sink and Faucet	47	Cleaning Fabrics	70
Water Treatment Unit	47	Cleaning Fabrics (With Cleaning Fluids)	70
Bathroom Facilities	48	Cleaning Fabrics (With Detergent Foam Cleaner)	70
Standard Toilet	48	Cleaning Leather or Vinyl Trim	71
Recirculating Toilet	49	Removal of Specific Stains	71
Bathroom Sink and Shower Control Valve	50	Belt Restraint Care	72
Bathroom Warm Air Duct	51	Glass Surfaces	72
Bathroom Exhaust Fan	51	Window Screen Removal	72
Ventilation	52	Window Screen Installation	72
Windows	52	Exterior Appearance Care	73
Ceiling Vents	52	Washing	73
Roof-Mounted Air Conditioner	53	Polishing and Waxing	73
Furnace	54	Protection of Exterior Bright Metal Parts	73
Furniture	56	Foreign Material Deposits	73
<u>In Case of Emergency</u>	61	Finish Damage	73
Four-Way Hazard Warning Flasher	61	Cleaning White Sidewall Tires	73
Emergency Starting	61	Underbody Maintenance	73
Jump Starting	61	Undercoating	74
Jump Start Procedure	62	GM Vehicle Chemicals	74
Alternate Procedure	63	<u>Service and Maintenance</u>	75
Engine Coolant	63	Maintenance Schedule	76
Engine Coolant Caution	64		
Jack Usage Instructions	64		
Towing	65		

TABLE OF CONTENTS

SUBJECT	PAGE NO.	SUBJECT	PAGE NO.
Accessibility	76	Onan Motor Generator Maintenance . . .	99
Exterior Compartments	76	Standard Toilet	105
Engine Accessibility	78	Recirculating Toilet	106
Engine Compartment Light	78	Draining Holding Tank	107
Hoisting Instructions	78	Draining Living Area Water System . .	107
Lubrication Details	79	Water Tank Filler	109
Engine	79	Sanitizing Living Area Water System	110
Transmission	81	Winterization	111
Final Drive	82	Vehicle Storage	111
Steering System	83	Vehicle Trip Preparation	113
Brake System	83	<u>General Data and Specifications</u>	115
Servicing Details	84	<u>Owner Assistance</u>	123
Engine Cooling System	84	U.S. Zone Territories	124
Cooling System Care	84	U.S. Zone Offices	125
Engine Fuel System	86	General Motors Overseas Offices	125
Carburetor	87	GM of Canada Limited—Zone Offices . .	126
Chassis Electrical System	87	24-Hour Phone Assistance	127
Wheels and Tires	91	Emergency Service	127
Front Suspension	94	Maintenance Manual and Parts Book . .	127
Rear Suspension	95	Facts About Gasoline Mileage	128
Underbody Maintenance	96	<u>Index (Alphabetical)</u>	129
LP Gas System	96	Gas Station Information . . Inside Back Cover	
Living Area Electrical System	97		

IMPORTANT INFORMATION ON VEHICLE LOADING

CAUTION

The components of your vehicle are designed to provide satisfactory service if the vehicle is not loaded in excess of either the Gross Vehicle Weight Rating (GVWR) or the maximum front and rear Gross Axle Weight Ratings (GAWR's) specified on the vehicle identification number (VIN) plate located behind the right front access door. Overloading can create serious potential safety hazards and shorten the service life of your vehicle. Your dealer can advise you concerning proper loading conditions of your vehicle.

When loading the Motorhome, it is important that it is properly loaded. All items should be loaded as centrally and as low as possible. This is essential to maintain proper vehicle handling. Even though a single item may not

weigh much alone, several of these items may have considerable weight. Proper loading is essential.

MAXIMUM FRONT AND REAR AXLE WEIGHTS (AS MANUFACTURED)

The weight of the cargo load must be properly distributed over both the front and rear axles. The plate shows the maximum weight that the front axle can carry (front GAWR) and the maximum weight that the rear axle (rear GAWR) can carry. The GVWR represents the maximum permissible loaded weight of the vehicle and takes into consideration the engine, transmission, frame, suspension, brake, axle and tire capabilities. Actual front and rear end weights can only be determined by weighing the vehicle. This can be accomplished through highway weigh stations or other such commercial facilities. For assistance in this regard, consult your dealer. The cargo load should be distributed

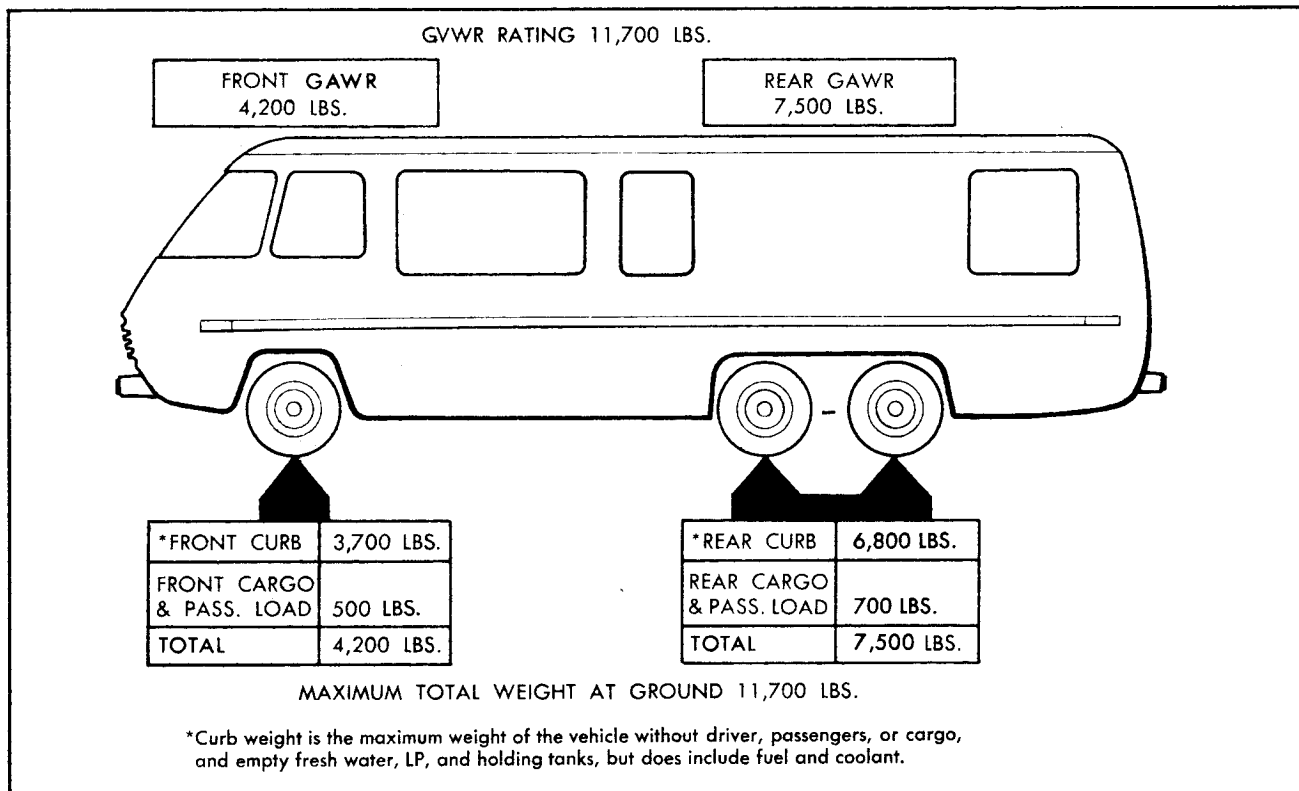

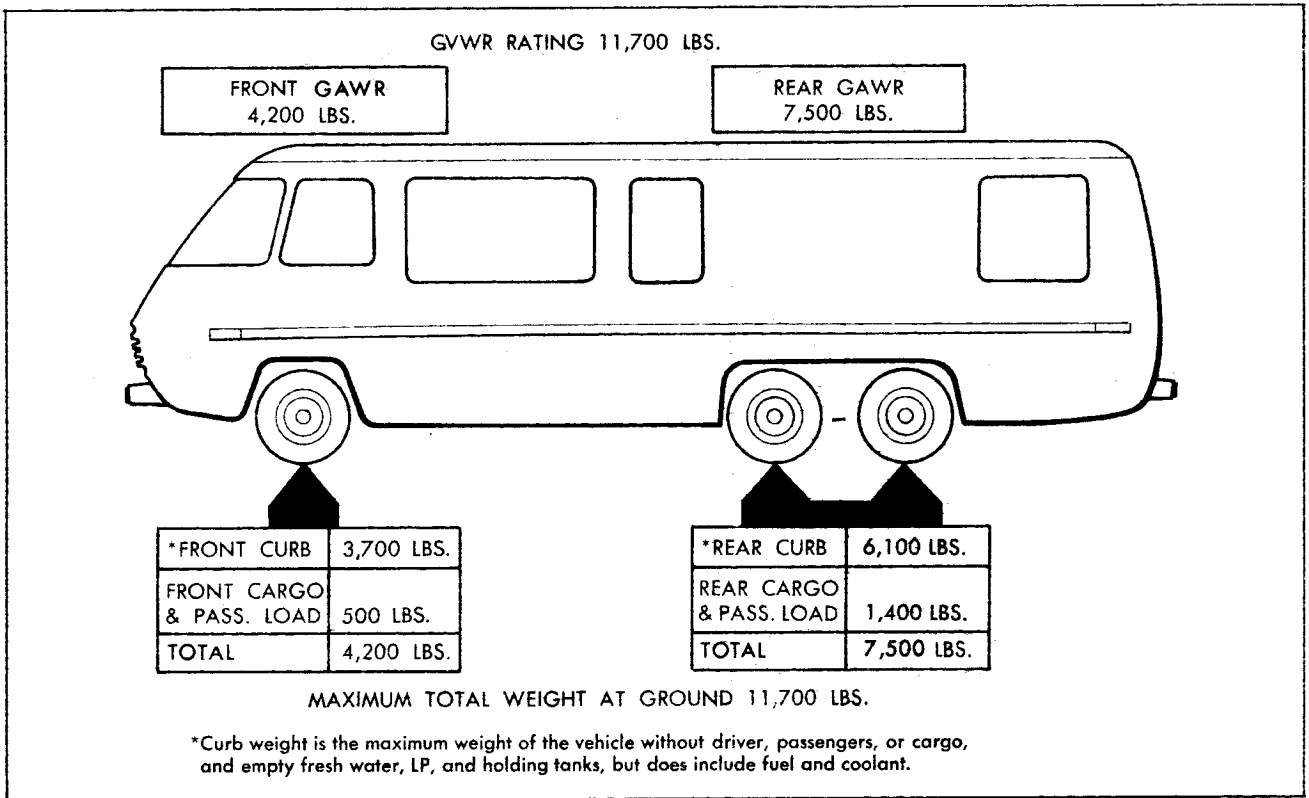

Vehicle Loading (ZEO 6584)

on both sides of the centerline of the vehicle as equally as possible.

ALLOWABLE LATERAL WEIGHT VARIATION

The independent suspension on this vehicle could be adversely affected by an unbalanced load on either side of vehicle. The allowable front lateral weight variation is 250 pounds. The allowable rear lateral weight variation is 600 pounds.

Lateral weight variations in excess of the above, can result in abnormal vehicle handling.

VIN (Vehicle Identification Number) Plate

The vehicle identification number plate shows the GVWR and the front and rear GAWR's for the vehicle to which they are attached.

Gross Vehicle Weight (GVW) is the weight of the vehicle itself, all items added to the vehicle after it has left the factory, the driver and all occupants, and everything that is loaded into (or onto) the vehicle. *The GVW must not exceed the GVWR* and the front and rear weights of the loaded vehicle must not exceed the front and rear GAWR's.

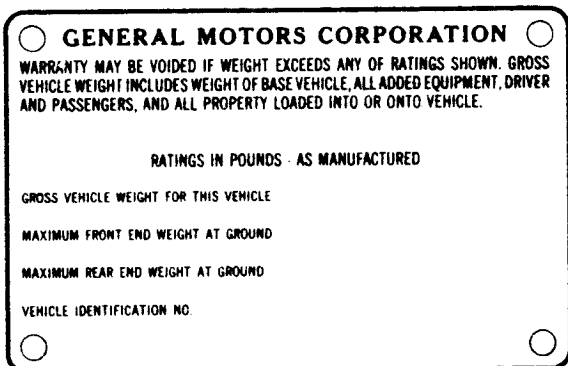

Vehicle Identification Plate

CAUTION

When using your vehicle to transport luggage or other cargo, it is recommended that all articles be secured in place. This precaution will help prevent such items from becoming dangerous projectiles in the event of an accident.

EFFECT ON WARRANTY

Your New Vehicle Warranty does not apply to any part of your vehicle "which has been subject to misuse." Any part which fails because of over-

loading has been subject to misuse within the meaning of this provision of the warranty.

TIRES

It is important that the tires on your vehicle

be of the proper size, and be properly inflated. It is important to avoid over-inflation as well as under-inflation. See the **SERVICE AND MAINTENANCE** section for proper tire inflation pressures.

For continuing satisfaction keep your vehicle all GM. General Motors Parts are identified by one of these trademarks:



GMC MOTORHOME NOTES

BEFORE DRIVING YOUR MOTORHOME

DRIVER CHECK LIST

BEFORE ENTERING VEHICLE

1. See that windows, mirrors, and lights are clean.
2. Visually note inflation condition of tires.
3. Check that all exterior lights work.
4. Turn off LP gas valve on LP tank (See CAUTION under "LP Gas System" in SERVICE AND MAINTENANCE section).
5. Check that sewer connection, all external compartments, and filler openings are properly stowed or closed and/or locked.
6. Check that items stored on exterior of vehicle are securely lashed.
7. Will any items stored on exterior of vehicle present a clearance problem?
8. Are there any rocks, posts, low-hanging lines or branches under or near the vehicle you must avoid before driving away?
9. Check that area to rear of vehicle is clear if about to back-up.

BEFORE DRIVING OFF

1. Lock entrance door.
2. Check that all windows are in suitable position for travel (See "Engine Exhaust Gas Caution (Carbon Monoxide)" at the beginning of STARTING AND OPERATING VEHICLE section. Close all roof vents.
3. Turn off living area water pump.
4. Check that refrigerator door is fastened.
5. Check that nothing heavy is stored in overhead or high cabinets—it may fall out enroute and cause injury.
6. Close and secure bathroom, closet, and all cabinet doors and drawers.
7. Check that counter tops, range top, kitchen sink, table tops and shelves are clear—even small items may become projectiles in an accident. It is not safe to cook while underway—hot food or liquid may scald in a sudden stop or accident.
8. Be sure all LP gas controls on furnace, range/oven and gas/electrical refrigerator (if so equipped) are turned off.

9. Check that all interior stowage is securely held.
10. Check that all lights and switches are set in positions suitable for travel.
11. Position driver's seat for comfort.
12. Check that driver's and front passenger's seat, and any other swivel-mounted seats are locked in position.
13. Check adjustment of inside and outside mirrors. Adjust curtains where necessary for visibility.
14. If vehicle is equipped with optional Electro-Level System, check that TRAVEL switch is positioned in "HOLD."
15. Fasten belt restraints.
16. Check that warning light bulbs light when key is turned to ON or START position.
17. Check all gauges.
18. Release parking brake, and see that the "PARK BRAKE" light turns off).
19. With engine running, check that warning lights are now out.
20. Be sure you understand your vehicle and how to operate it and its systems and equipment safely.
21. It is recommended that you refer to "TRIP TIPS" and "DRIVING TIPS" at the end of this section for additional information.

CAUTION

Counter and table tops should not be used for storage when underway—even for light weight, small articles. They might become dangerous projectiles during an accident. Heavy items stored in overhead or waist-high cabinets may also cause injury if a sharp turn or stop causes them to topple against inside of cabinet door, forcing it open. Store canned goods and other heavy items down low.

INSIDE REARVIEW MIRROR

To raise or lower mirror to achieve desired field of view, grasp mirror and exert sufficient pressure by pushing or pulling up, down, or sideways. Switch mirror to night position to reduce glare from following headlights.

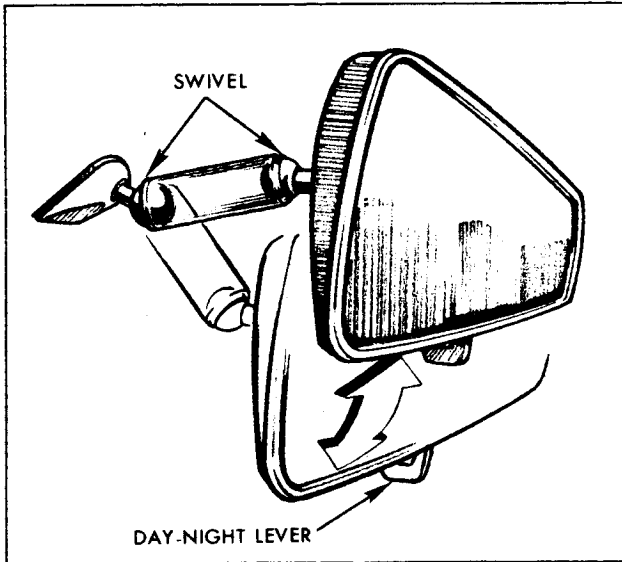

Inside Rearview Mirror

OUTSIDE REARVIEW MIRROR

Adjust the outside mirror so you can just see the side of your vehicle in the inboard portion of the mirror.

KEYS

Two separate identifiable keys – with different cross section – are provided for the lock cylinders on your vehicle. The key codes are stamped on the “knock out” plug in the key head.

Key with Square Head—For ignition switch only.

Key with Oval Head—For door lock, glove box,

water tank fill door and external utilities compartment.

For vehicle security:

- Remove the knock out plugs from the keys and record the code numbers.
- Keep the key codes in a safe place such as your wallet, **NOT IN THE VEHICLE.**

In the event the original keys are lost, duplicates can be made by your dealer or a locksmith using the key code information.

If it is necessary to park in an attended lot separate and leave your square ignition key only. Lock your glove box and take the round key with you. This will prevent any unauthorized entry into the glove box.

NOTE: If the refrigerator is equipped with a lock, a third key will be provided.

ENTRANCE DOOR

DOOR LATCH

Door must be locked from outside the vehicle by inserting the key into the door key lock and turning. To unlock, turn in the clockwise direction. Reverse the direction to lock.

To lock door from inside vehicle, push the lock button **DOWN**. To unlock and open door from the inside, pull the lock button **UP** and pull on inside door handle.

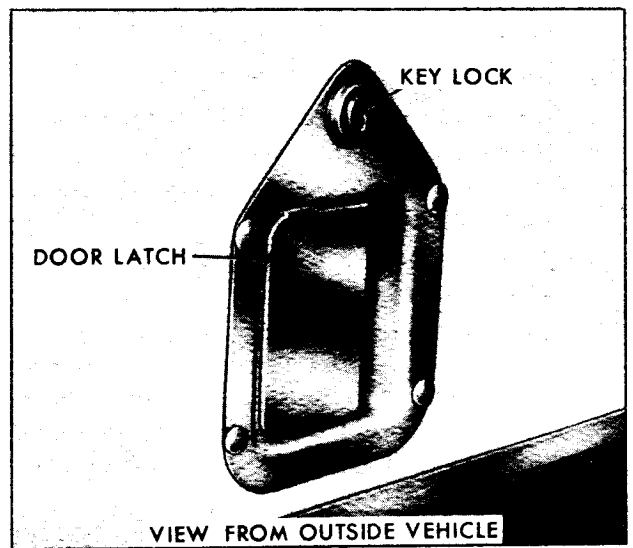
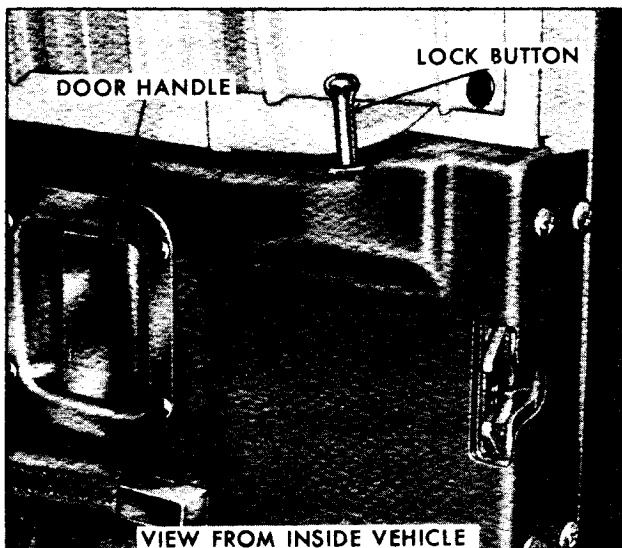

Entrance Door Latch

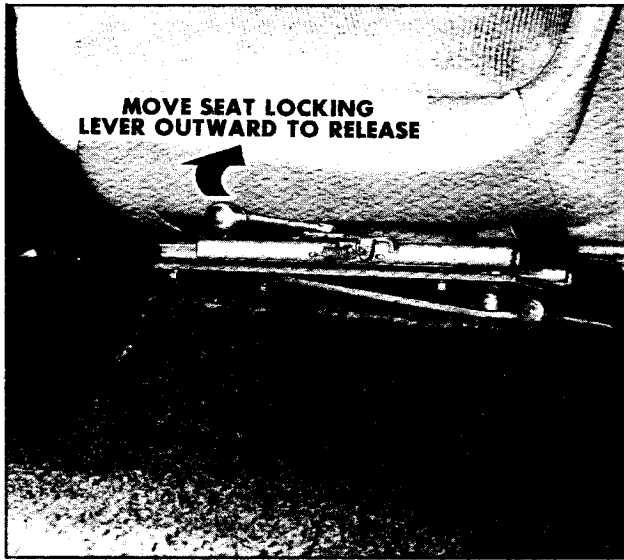

Seat Track Mechanism (Typical)

REMINDER: Always lock entrance door when driving for greater security in the event of an accident, to help keep children from inadvertently opening door, and for greater security against entry by unwelcome persons while momentarily stopped.

SEATS

DRIVER AND FRONT PASSENGER SEATS

The driver and front passenger seats may be adjusted to suit an individual's preference. To move seat forward or backward, simply release the seat locking lever located on the aisle side of the seat. Once released, exert slight body pressure in the direction desired. Release lever to lock the seat in the desired position.

The seats can be swiveled to provide easy entrance and exit. To swivel seat, depress seat swivel lever (as shown), then rotate seat. The seats are designed to lock only in the forward facing position.

CAUTION

After adjusting a manually operated seat, always use body weight to push forward and backward on seat and to twist seat — to assure that seat adjusters and swivel lock have securely engaged in the new position. Motion of the seat indicates that at least one adjuster or the lock did not engage,

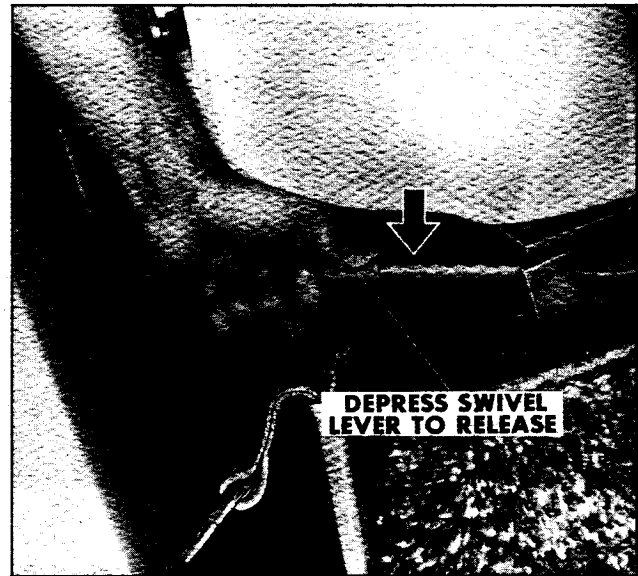

Seat Swivel Mechanism (Typical)

which could increase the chance of injury and/or the severity of injury in the event of an accident. If this condition persists, take the vehicle to your dealer for service.

Do not adjust a manually operated driver's seat swivel or fore and aft mechanism while the vehicle is moving—the seat could move unexpectedly, possibly causing loss of control of the vehicle.

Arm Rests

The driver and front passenger seats are equipped with arm rests.

When arm rests are being used, they should be

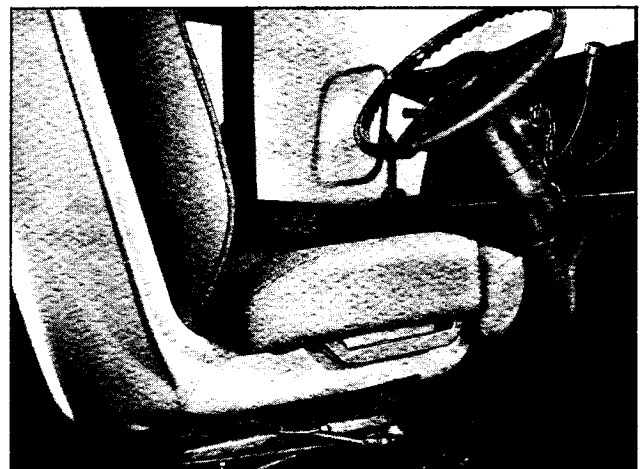

Arm Rest in the DOWN Position

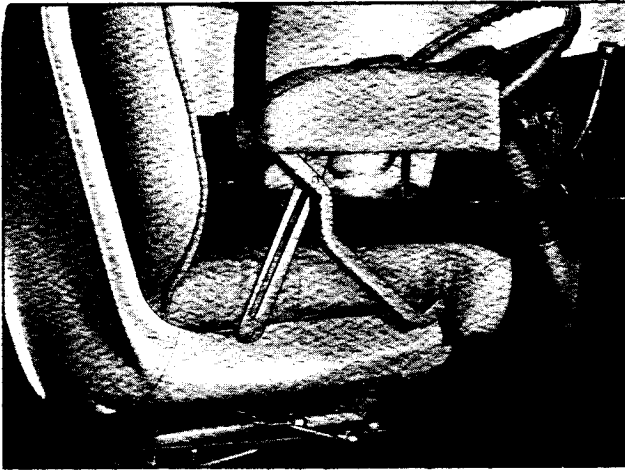

Arm Rest in the UP Position

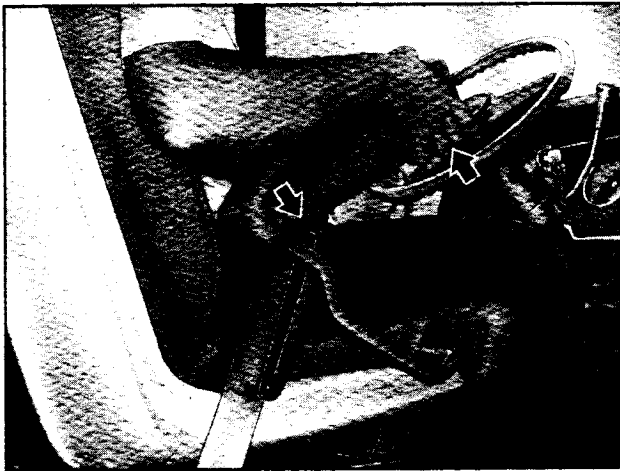

Lowering Arm Rest

placed in the DOWN position (as shown). To use, grasp arm rest by the front and lift, until arm rest is in the UP position (as shown). To lower, grasp arm rest by the front and lift, then lower assembly (as shown) into seat.

LIVING AREA SWIVEL SEATS

The optional swivel seats (behind the driver's seat) may be swiveled or adjusted for height as described in the following:

Swiveling Seat

1. To swivel seat to desired position, depress seat locking lever (straight handled lever located on right side of pedestal—below right side of seat in travel position).

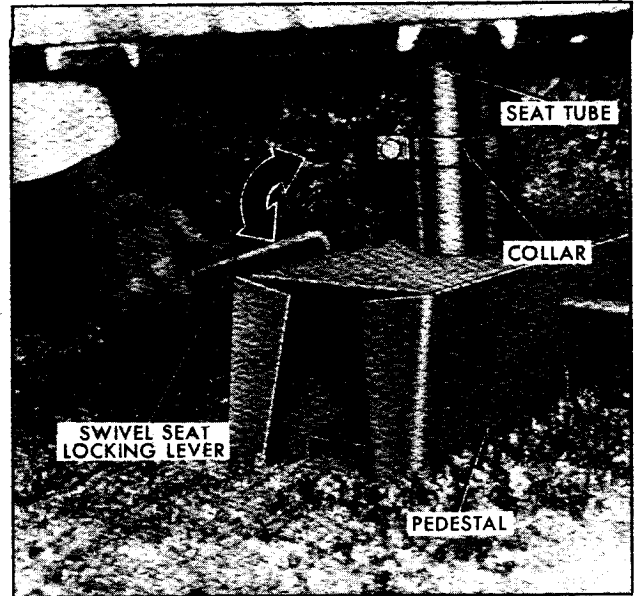

Releasing Swivel Seat Locking Lever

2. To temporarily hold seat in position, while vehicle is stationary, tighten seat friction lever (angled lever on the left side of pedestal—below left side of seat in travel position) by rotating lever clockwise.

3. To return swivel seat to the correct position for traveling, first loosen the swivel seat friction lever by rotating counterclockwise $1\frac{1}{2}$ to 2 turns.

4. Before driving off, ALWAYS rotate seats to travel position (both swivel seats facing each other). Check that swivel seat is locked in position by attempting to rotate seat.

5. If either living area swivel seat does not lock properly, perform swivel seat "Height Adjustment" as described below. If swivel seat mechanism still does not lock properly, take the vehicle to your dealer for service.

Height Adjustment

1. Using two $\frac{1}{2}$ " wrenches loosen the collar retaining bolt and nut assembly.

2. Depress swivel seat locking lever. Then raise or lower seat to desired height. Be sure swivel seat locking lever enters one of the holes provided in seat tube by attempting to rotate seat. If seat rotates, locking lever is not entering hole. Readjust seat height until it does. Then tighten collar retaining bolt and nut assembly.

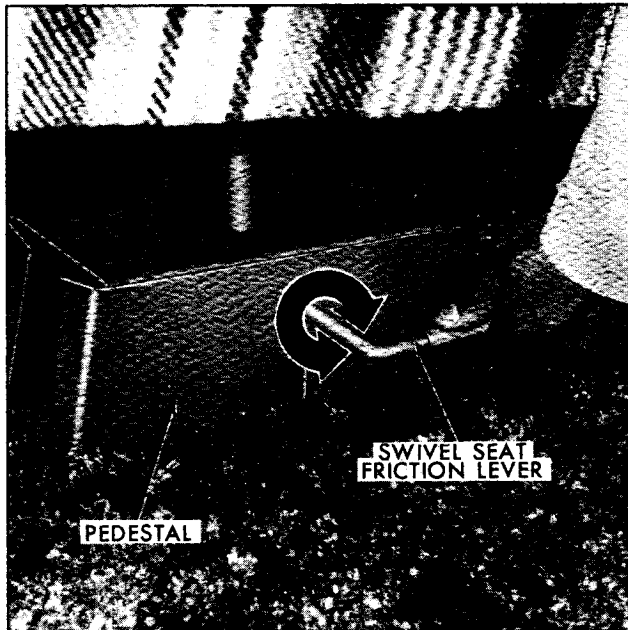

Positioning Swivel Seat Friction Lever

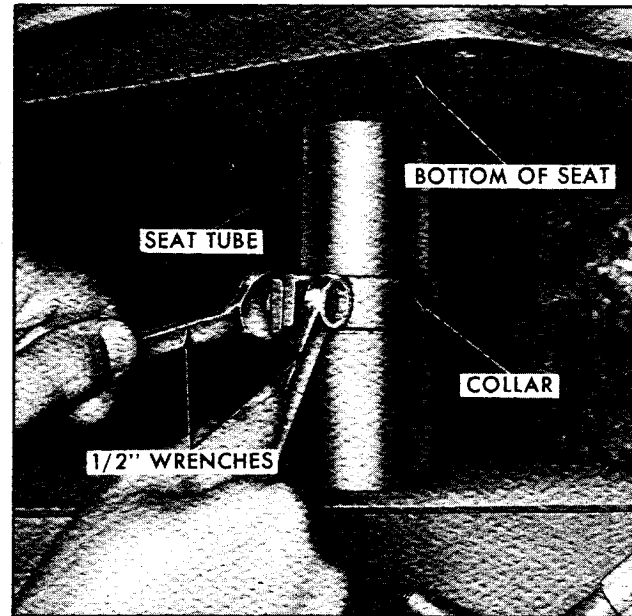

Adjusting Height of Swivel Seat

BELT RESTRAINTS

Your GMC Motorhome is equipped with lap belts in the driver and front passenger seating position(s), as well as certain other seating locations in the Motorhome. To help lessen the chance of injury and/or the severity of injury in accidents or sudden stops, General Motors recommends that people riding in the vehicle be properly restrained, with the belt restraints provided, including pregnant women and children of all ages. See following pages for information on restraint of pregnant women, and of children.

CAUTION

To help lessen the chance of injury and/or the severity of injury in the event of an accident:

Always put on lap belts with both arm rests in the **DOWN** position, taking care that lap belt is not wedged between arm rest and seat. Once lap belt is buckled snugly, the arm rest may be positioned for use.

DO NOT route lap belt in front of, through, or on top of the arm rest assembly when it is in use. See illustrations for proper routing of lap belts.

DO NOT reroute lap belts over arm rests of optional living area swivel

seats. To help achieve a snug fit and low lap belt position, these belts **MUST** be routed between seat cushion and arm rests.

A snug fit and a low lap belt position are essential to lessen the chance of injury and/or the severity of injury in the event of an accident, because this spreads the force by the lap belt in a collision over the strong hip bone structure rather than across the soft abdominal area.

Never use the same belt for more than one person at a time; avoid wearing belts in a twisted condition; do not allow belts or hardware to become damaged by being pinched between the seat structural (metallic) members or in the door.

The driver and front passenger seating positions — have belt retractors which are designed to automatically take up excess webbing.

- Adjust seat to your satisfaction and sit erect and well back in the seat.
- In a single motion, pull webbing across lap far enough to permit inserting metal latch plate end of lap belt into the buckle, until a snap is heard. If webbing is not pulled out far



Lap Belt (Front Seating Positions)

enough to reach the buckle, let the belt rewind into the retractor to release lock mechanism, so belt can be pulled out to the proper length.

- Position lap belt across lap as **LOW ON HIPS** as possible. To reduce the risk of sliding under the belt during an accident, adjust to a **SNUG FIT** by pulling belt firmly across lap in direction of retractor so it can take up slack.
- To unfasten seat belts, depress push button in center of buckle.
- When no longer in use, driver and front passenger lap belts can be stowed by allowing them to rewind into their retractors.

NOTE: Take care not to let the lap belt twist while it is being rewound into the retractor provided for driver and front passenger seat. The bulk of the twisted belt may cause the retractor to jam so it will not rewind further, while at the same time the retractor's locking mechanism may prevent the belt from being withdrawn. If a belt should become jammed, you may be able to release it by working the belt in and out until the belt rewinds far enough to unlock. If lap belt remains jammed or other parts of the restraint system do not operate properly take the vehicle to your dealer for service.

Lap belts at seating positions other than the driver and front passenger positions—should be



*Living Area Swivel Seats
Positioned for TRAVEL*

positioned and secured as above, and adjusted to a **SNUG FIT** by pulling on the end of the belt extending from the adjustable latch plate or buckle.

- To lengthen the lap belts at these seating positions, place adjustable latch plate or buckle at right angles to the belt webbing and pull on adjustable latch plate or buckle; belt should then slide easily through the adjustment feature.
- To unfasten seat belts, depress push button in center of buckle.

RESTRAINT OF PREGNANT WOMEN

To help lessen the chance of injury and/or the severity of injury to a pregnant woman and her unborn child in the event of an accident, General Motors recommends that pregnant women use the lap belt, worn as low and snug over the hips as possible, as advised for regular seat belt use.

LAP BELT INSPECTION

- Periodically inspect belts, buckles, latch plates, retractors, and anchors for proper operation, and also for damage that could lessen the effectiveness of the restraint system.
- Keep sharp edges and damaging objects away from belts and other parts of restraint system.
- Replace belts if cut, weakened, frayed, or subjected to collision loads.

- Check that the anchor mounting bolts are tight.
- Have questionable parts replaced.
- Keep belts clean and dry.
- Clean only with mild soap solution and lukewarm water.
- Do not bleach or dye belts since this may severely weaken them.

CHILD RESTRAINT

Children in vehicles should be restrained to lessen the risk of injury in accidents, or sudden stops. In using any infant or child restraint system, read and comply with all installation and usage instructions.

All unused lap belts near the child should be stowed properly to help prevent them from striking the child in the event of an accident. Lap belts without storage provisions should have buckles latched and belts adjusted to remove slack.

If a child is traveling in a vehicle not equipped with an appropriate infant or child restraint system, the following precautions should be taken:

1. Infants unable to sit up by themselves should be restrained by placing them in a covered, padded bassinet placed crossways in the vehicle (widthwise) on the seat. The bassinet should be securely restrained with the regular vehicle belts.

2. Children able to sit up by themselves should be placed on a seat and lap belted. Never allow a child to stand or kneel on any seat or elsewhere in the vehicle, once it is underway.

TRAILER HAULING

Towing a trailer will affect handling, durability and economy. Maximum safety and satisfaction depends upon proper use of correct equipment and avoiding overloads and other abusive operation.

The maximum loaded trailer weight which you can pull with your vehicle depends on what special equipment has been installed.

CAUTION

Do not attempt to tow any trailer over 1,000 pounds gross trailer weight regardless of the trailer towing equipment installed. This could overload your vehicle and seriously affect vehicle performance and vehicle handling which in turn could result in personal injury.

To assist in attaining good handling of the Vehicle Trailer Combination, it is important that the trailer tongue load be maintained at approximately 10% of the loaded trailer weight. Tongue loads can be adjusted by proper distribution of the load in the trailer, and can be checked by weighing separately the loaded trailer and then the tongue.

The GVW of this vehicle is reduced by an amount equal to the trailer tongue load on the trailer hitch. Actual weight reduction to compensate for trailer tongue load is made by reducing the passenger and cargo load.

CAUTIONS

To help avoid personal injury due to inadequate braking action:

- Before descending a steep or long grade, down a mountain or hillside, reduce speed and shift into a lower gear. Use the lower gear ranges to control vehicle speed. Avoid prolonged or frequent application of the brakes which could cause overheating and thus reduce brake effectiveness.
- Whenever a trailer hitch is removed, be certain to have any mounting holes in underbody properly sealed to prevent possible entry of exhaust fumes, dirt or water. (See "ENGINE EXHAUST GAS CAUTION" in the following section.)

TRAILER TOWING TIPS

Getting Underway

If the trailer is equipped with electric trailer brakes, before entering traffic, start the combination moving and manually apply the electric brakes to determine if the trailer brakes are operating and the trailer electrical system is connected.

Engine Cooling

In the event of an engine over heat condition, see the procedures in the "In Case of Emergency" section of this manual.

Long Uphill Grades

When ascending long uphill grades, the possibility of engine overheating can be reduced by down-shifting the transmission to a lower range gear and reducing speed to 45 mph (75 km/h) or below.

Transmission

See the procedure for checking the transmission fluid level in the Service and Maintenance edition of this manual.

Parking

Parking of vehicles with trailers on a grade is not recommended. However, should this be necessary, the following sequence should be used:

1. Apply regular brakes.
2. Have someone place wheel chocks under trailer wheels.
3. When wheel chocks are in place, release regular brakes until chocks absorb load.
4. Apply parking brake.
5. Place transmission selector lever in "PARK" position.

Reverse above sequence when starting.

If the vehicle is parked on a grade and the transmission selector lever is placed in "PARK" before the trailer wheels are chocked and parking brake is set, the weight of the vehicle and trailer exert so much force on the parking pawl in the transmission that it may be difficult to pull the selector lever out of "PARK."

OPERATION IN FOREIGN COUNTRIES

FUEL REQUIREMENTS

Your vehicle's engine is designed to operate on unleaded or leaded fuel of approximately 91 research octane number.

If you plan to operate your vehicle outside the continental limits of the United States or Canada, there is a possibility that the best fuels available are so low in anti-knock quality that excessive knocking and serious engine damage may result from their use. To obtain informa-

tion on the quality of fuels available in the countries in which you plan to travel write to GMC Truck & Coach Division, General Motors Corporation, Pontiac, Michigan 48053 (or in Canada write to General Motors of Canada Limited, Owner Relations Department, Oshawa, Ontario), giving:

- The vehicle identification number (from plate attached to right side of dash panel or from the registration slip or title).
- The country or countries in which you plan to travel.

It is recommended that you do not operate your vehicle in any country not having fuels meeting the requirements of your vehicle's engine as these **MAY CAUSE ENGINE DAMAGE** for which GMC Truck & Coach is not responsible under the terms of the New Vehicle Warranty or Emission Control Systems Warranty.

EXTERNAL ELECTRICAL POWER

In many countries outside of the United States and Canada, the electrical power supplied may not be compatible with your Motorhome electrical system. Serious appliance and electrical component damage will result if incorrect electrical power is used. Such damage is not covered by the New Vehicle Warranty. For additional details on external power, refer to **LIVING AREA ELECTRICAL SYSTEM** found later in this manual.

COMPONENT REPAIRS

Component repairs require the use of special tools and equipment. Technicians specially trained in the repair of Motorhomes and replacement parts may not be readily available outside of the U.S. causing delays and customer inconvenience. GMC is not responsible for any inconvenience which may result from these delays.

CB TRANSCEIVER

Operation of CB (Citizens Band) transceiver may be prohibited in some countries. In others, operation of this equipment requires a special permit besides the valid station license. (Permits should be obtained before you leave the United States.)

To operate a CB unit in Canada, get a permit from a regional office of the Canadian Department of Communications. For information re-

garding other countries, contact the local consulates of the countries in which you plan to travel.

TRIP TIPS

A small amount of preparation prior to a trip will save a lot of time when traveling.

When loading heavy items into your Motorhome try to store them as low and centrally as possible. This will aid performance and handling of the vehicle. Remember even though an item may not weigh much individually the sum weight of several of these articles may be substantial.

CAUTION

When transporting luggage or other cargo in your Motorhome, it is recommended that all articles be secured in place. This precaution will help prevent such items from becoming projectiles in the event of an accident.

The following emergency equipment is recommended, at minimum:

- Fire Extinguisher
- Hydraulic Jack and Lug Wrench
- Spare Tire
- Flashlight
- First Aid Kit
- Road Emergency Flares
- Basic Tool Kit

NOTE: If vehicle is equipped with (optional) fender skirts, be sure tool kit includes a No. 2 cross-recessed screwdriver and 9/16" wrench or socket to aid in fender skirt removal, if necessary to change a rear tire.

These items might be found useful:

- Plastic Bucket and Funnel
- Water Hose and "Y" Connection, in case of two units on one water system
- Level
- Shovel
- Spare Automotive Fuses and Bulbs
- 2" x 4" Chocks or Blocks

The following checks should be made before starting on a trip:

OUTSIDE VEHICLE

1. Run through "Driver Check List" at the beginning of this section.

2. Check engine oil level.
3. Check fluid levels on batteries.
4. Visually inspect radiator coolant level.
5. Fill windshield washer reservoir.
6. Check tire pressure, and inspect tires for road damage, foreign objects.
7. Check operation of all outside lights.
8. Check that all exterior vents are unobstructed.
9. Check and empty holding tank.

INSIDE VEHICLE

1. Check operation of optional Electro-Level System.
2. Check gasoline supply.
3. Check transmission fluid level.
4. Check power steering fluid level.
5. Check operation of windshield wipers and windshield washers.
6. Check operation of brakes.
7. Check operation of interior lights.
8. Check all appliances and fixtures for proper operation.
9. Check operation of motor generator.
10. Check and fill living area water system.
11. Check and fill LP gas tank.
12. Check Maintenance Schedule folder to make sure all periodic maintenance and safety checks have been performed.
13. After the vehicle has been loaded, check to see that the vehicle's Gross Vehicle Weight, and front and rear axle capacities have not been exceeded. This check should be made fully loaded including passengers. (Refer to the "IMPORTANT INFORMATION ON VEHICLE LOADING" section of this manual for further information.)

Before leaving any camp-site make sure all litter has been picked up.

When traveling in winter it is recommended that the water tank not be filled until the destination is reached. This will ensure that the vehicle has thoroughly warmed up. The water and holding tank systems should be drained before leaving for home. Also, at this time, put some non-toxic, non-flammable anti-freeze into the sink and shower traps. Heat tape has been found useful in preventing pipe freeze-up, where power is available. Some non-toxic, non-flammable anti-freeze in the holding tank will help keep the tank contents from freezing. The

recirculating toilet should be drained immediately at the end of the trip.

DRIVING TIPS

The Motorhome driver controls are automotive-type to make the vehicle as comfortable as possible. The steering and braking controls are power assisted to help make driving as effortless as possible. However, it must be remembered that the Motorhome is much higher, wider, and heavier than a family automobile.

Since the Motorhome is 9-ft. 2-in. high, with the roof mounted air conditioner, additional care is required to watch for low bridges and overpasses. **TREE BRANCHES CAN DO CONSIDERABLE DAMAGE TO THE WINDSHIELD OR ROOF OF THE VEHICLE TOO, SO WATCH FOR THEM.**

The Motorhome power-to-weight ratio is lower than that of the average automobile. Therefore it is essential to compensate for less acceleration when moving into traffic, or when passing another vehicle.

GMC MOTORHOME NOTES

STARTING AND OPERATING VEHICLE

ENGINE EXHAUST GAS CAUTION (CARBON MONOXIDE)

Avoid inhaling exhaust gases because they contain carbon monoxide which by itself is colorless and odorless. Carbon monoxide is a dangerous gas that can cause unconsciousness and is potentially lethal.

If, at any time, you suspect that exhaust fumes are entering the Motor-home from any source have the cause determined and corrected as soon as possible. If you must drive before the cause is corrected, drive only with ALL except two rear windows FULLY open and heating or cooling system adjusted for maximum ventilation (see below).

The best protection against carbon monoxide entry into the vehicle body is a properly maintained engine exhaust system, body and body ventilation system. It is recommended that the exhaust system and body be inspected by a competent mechanic:

- Each time the vehicle is raised for lubrication or oil change.
- Whenever a change is noticed in the sound, alignment, or appearance of the exhaust system.
- Whenever the exhaust system, underbody or rear of the vehicle is damaged.

See your Maintenance Schedule folder for inspection procedure.

To allow proper operation of the vehicle's ventilation system, keep front inlet grille clear of snow, leaves, or other obstructions at all times.

OCCUPYING A PARKED VEHICLE WITH ENGINE RUNNING FOR AN EXTENDED PERIOD OF TIME IS NOT RECOMMENDED.

Do not run engine in confined areas such as garages any more than needed to move vehicle in or out of area. When vehicle is stopped in an UNCONFINED area with the engine running for any more than a short period of time, adjust heating or cooling system to force outside air into the vehicle as follows:

- Set fan to medium or high speed, upper control lever to any position except "OFF."

The two rear windows should be closed while driving to avoid drawing dangerous exhaust gases into the vehicle through those openings. In addition, it is recommended that roof vent(s) be closed while driving. If, for some reason, a rear window or roof vent must remain open for a period while driving, or electrical wiring or other cable connections to a trailer must pass through the seal between them and the body, the following precautions should be observed.

- Close all windows.
- Adjust heating or cooling system to force outside air into the vehicle as described above but with fan set at high speed.
- Air vents in or under the instrument panel should be fully open.

It is important that the inside engine cover be properly seated to prevent possible leakage of exhaust fumes into the vehicle through this opening.

See "LIVING AREA FACILITIES CAUTION (CARBON MONOXIDE)" on page 35.

STEERING COLUMN CONTROLS

ANTI-THEFT STEERING COLUMN LOCK

The anti-theft ignition switch, located on the right side of the steering column, has five positions:

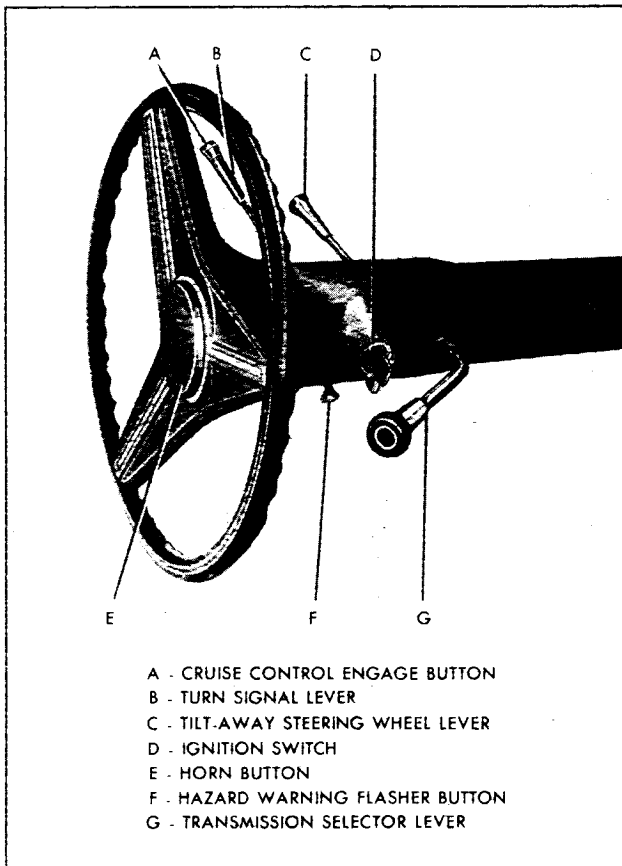

Steering Column Controls

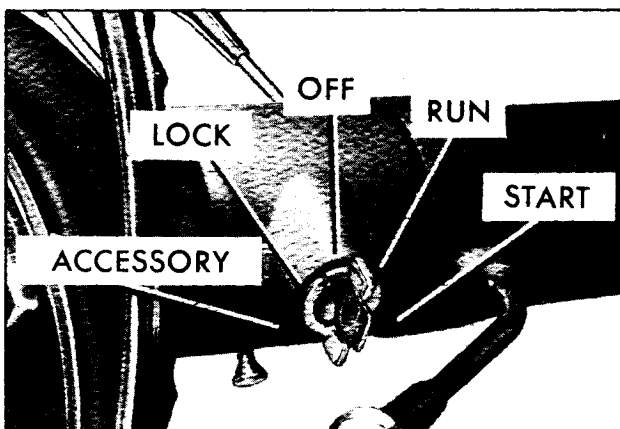

Anti-Theft Steering Column Lock

- **ACCESSORY**—Permits operation of electrical accessories when the engine is not running. To engage, push key in and turn toward you (counterclockwise).
- **LOCK**—Normal parking position, locks ignition and provides added theft protection by preventing normal operation of steering wheel and shift controls. Key cannot be returned to “LOCK” position and removed until transmission is placed in “PARK.”
- **OFF**—Permits turning engine off without locking steering wheel and shift controls.
- **RUN**—Normal operating position.
- **START**—Permits engagement of starter.

NOTE: The anti-theft steering column lock is not a substitute for the parking brake. Always set the parking brake when leaving the driver’s seat unattended.

If difficulty is experienced in turning the ignition key and lock knob to unlock the ignition, attempt to turn the steering wheel as hard as possible in the direction the wheels are turned. At the same time turn the ignition-lock knob in a clockwise direction with as much effort as you can apply with your own hand. Do not attempt to use a tool of any kind to apply additional force on the lock knob, as this could break the knob.

THEFT PROTECTION

Your new Motorhome has been equipped to help prevent theft of the vehicle itself, its equipment, and contents. However, these security features **DEPEND UPON** your cooperation to be effective.

THE TIME TO BE MOST ON GUARD IS WHEN LEAVING THE VEHICLE

- **LOCK THE STEERING COLUMN AND TAKE THE KEYS:**
 - Turning the key to the “LOCK” position and removing the key is designed to lock the ignition and **BOTH** steering and shift controls.
 - If it is necessary to leave a key with the vehicle, leave the square head ignition key only; take the round head key with you.

This will help prevent unauthorized entry into your vehicle at a later date or into your glove box (if locked).

- **FULLY CLOSE ALL WINDOWS AND LOCK ALL DOORS.**
- **KEEP VALUABLES OUT OF SIGHT.**
 - Never leave things of value in plain sight.
 - The glove box offers a place to hide small items (and if locked, provides still more security).

PARKING

When leaving the driver's seat unattended:

- **SET PARKING BRAKE FIRST.** (See note on page 22.)
- Place transmission selector lever in "PARK."
- Turn key to LOCK position.
- Remove key from steering column lock (the buzzer will remind you).
- Lock entrance door if leaving vehicle.

NOTICE: Do not leave your vehicle unattended with the engine running. If the engine should overheat while your vehicle is unattended, the temperature warning light or gauge would go unheeded which could result in extensive damage to your vehicle.

STARTING ENGINE

1. Apply the parking brake.
2. Place the transmission selector in "PARK" or "N" ("PARK" is preferred). A starter safety switch is designed to prevent starter operation while the transmission selector is in any drive position. (If it is necessary to re-start the engine with the vehicle moving, place the selector lever in "N".)
3. Depress accelerator pedal and activate starter as outlined in the following, for different conditions.

COLD ENGINE

Fully depress accelerator pedal and slowly release. With foot off the pedal, crank the engine by turning the ignition key to the "START" position—release when engine starts. If engine

starts but fails to run, repeat this procedure. When engine is running smoothly (approx. 30 seconds) the idle speed may be reduced by slightly depressing the accelerator pedal and then slowly releasing.

CAUTION

Extended running of the engine (5 minutes or more) without depressing the accelerator pedal, could cause damage to the engine or exhaust system due to overheating.

WARM ENGINE

Depress accelerator pedal about halfway and hold while cranking the engine.

EXTREMELY COLD WEATHER (BELOW 0° F.) (—18° C.) OR AFTER VEHICLE HAS BEEN STANDING IDLE FOR SEVERAL DAYS

Fully depress and release accelerator pedal two or three times before cranking the engine. With foot off the accelerator pedal, crank the engine by turning the key to the "START" position—release key when engine starts.

IF ENGINE FAILS TO START:

- First, fully depress and release the accelerator pedal several times, then remove foot from accelerator pedal and crank engine.
- If engine still does not start, fully depress the accelerator pedal and hold to the floor while cranking the engine.
- If the engine has been flooded with gasoline, it may start to run but not have enough power to keep running. In this case, continue cranking with the accelerator pedal fully depressed until the engine cleans itself of excess gasoline and runs smoothly.
- If engine doesn't crank properly due to a discharged main battery (automotive battery), place the battery switch in the "BAT BOOST" position. Switch is designed to return to the "BAT NORMAL" position after use.

NOTE: Do not continue cranking the engine for more than 30 seconds at a time to prevent starter overheating.

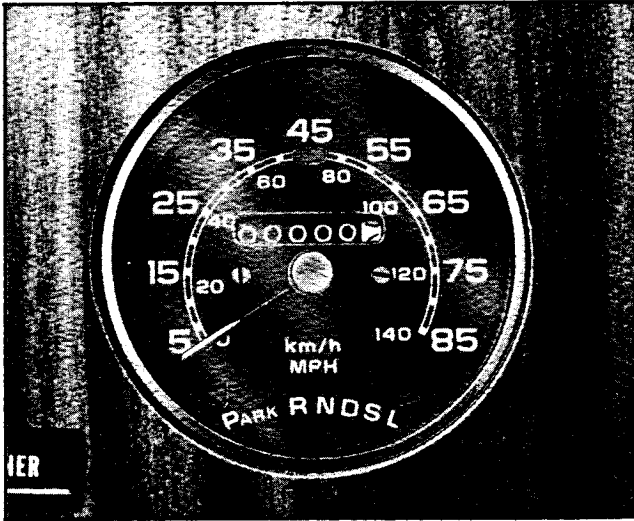

*Transmission Shift Indicator
and Speedometer*

AUTOMATIC TRANSMISSION

The transmission selector lever is located on the right side of the steering column and the shift indicator is located in the bottom section of the speedometer cluster on the dash.

- **“PARK”**—Transmission lock when parking or while starting the engine. Pull the selector lever towards you to select or release this position. Never move the selector lever to “PARK” position unless the vehicle is completely stopped. “NEUTRAL” is the only other position in which your vehicle may be started.
- **REVERSE “R”**—For backing the vehicle. Bring the vehicle to a complete stop before moving the selector lever into Reverse.
- **NEUTRAL “N”**—The out-of-gear position. It is provided for starting a stalled engine while the vehicle is in motion or running the engine while standing with brake applied. **DO NOT COAST IN NEUTRAL.**
- **DRIVE RANGE “D”**—The driving range for city and highway driving. This position permits the transmission to operate through its complete range of gear ratios and to select automatically the proper ratio for road and load conditions.
- **SUPER RANGE “S”**—Used when super performance is needed for increased acceleration in traffic, hill climbing, or “Engine Braking” down-hill. The selector lever may be moved

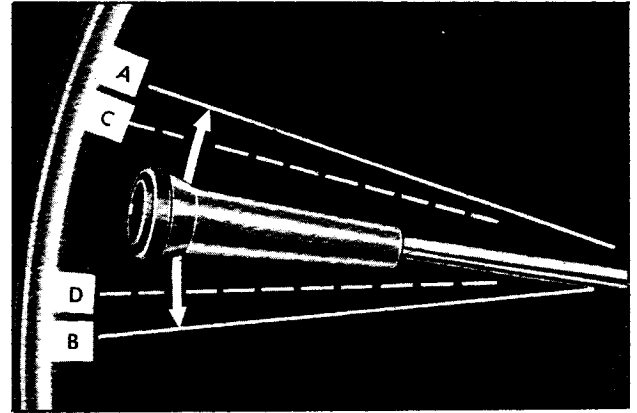

Turn Signal Lever

from “D” to “S” and vice versa, under most operating conditions. “SUPER” should not be used at speeds above 75 MPH.

- **LOW “L”**—Available for heavy pulling through mud or sand and for engine braking when descending steep hills. The selector lever may be moved to “L” at any speed but the transmission will only shift automatically into Low range when the vehicle speed is under approximately 40 MPH. The transmission will not upshift from Low range as long as the selector lever is in the “L” position.

CAUTION

Before descending a steep or long grade, down a mountain or hillside, reduce speed and shift into a lower gear. Use the lower gear ranges to control vehicle speed. Avoid prolonged or frequent application of the brakes which could cause overheating and thus reduce brake effectiveness.

Use caution when accelerating or shifting into lower range or lower gear on slippery surfaces with vehicle moving—abrupt acceleration or engine braking action could cause the front wheels to skid, possibly leading to loss of vehicle control.

- **FORCED DOWNSHIFT**—When additional acceleration is desired to pass moving vehicles or to climb steep grades at speeds between approximately 35 and 65 MPH, the transmission can be downshifted by depressing the accelerator pedal completely to the floor. It is also possible to obtain a forced

downshift in "DRIVE" range at speeds under 35 MPH by depressing the accelerator pedal part way down.

TURN SIGNAL AND LANE CHANGE FEATURE

Whenever a right or left turn is intended, when changing lanes, or when pulling away from the curb, use the turn signals.

- **FULL TURN** – For normal turns, move the turn signal lever to position "A" for right turn and "B" for left turn. Lever will remain in position without manual effort until the turn is completed, then cancel automatically.
- **LANE CHANGE** – Move lever to the detent position "C" for change to right lane or to "D" for change to left lane. Hold lever in position until lane maneuver is completed, then release. Lever will return to "OFF" position.

HAZARD WARNING FLASHER

For operation of hazard warning flasher, see "In Case of Emergency" later in this manual.

HORN CONTROL

The horn is actuated by depressing the button or spokes located in the center of the steering wheel.

POWER STEERING

If the steering system power assist fails due to some malfunction, or because the engine has stalled, the vehicle can still be steered. However, much greater effort is required, particularly in sharp turns.

TILT STEERING WHEEL

The tilt steering wheel can be tilted up above normal position to provide additional room for entrance and exit as well as selected driving positions above or below normal height.

The tilt mechanism is operated by lifting up on the small control lever, on the left side of the steering column just below the directional signal lever, then moving the steering wheel to the selected position and releasing the lever.

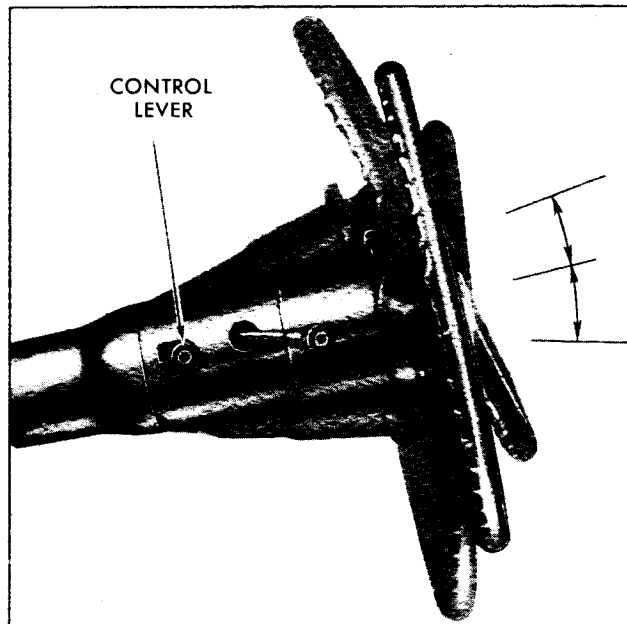

Tilt Steering Wheel

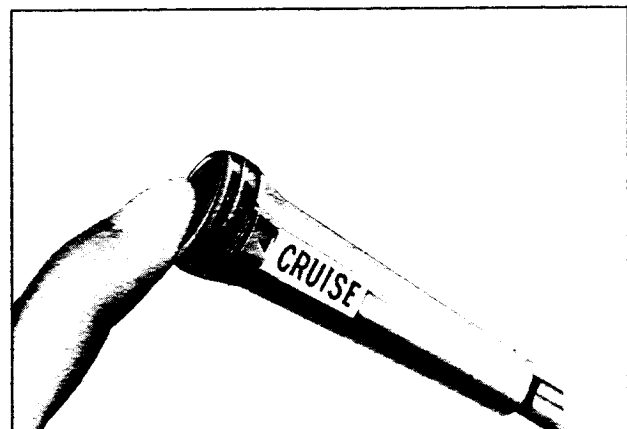

Cruise Control Lever

CRUISE CONTROL

The optional Cruise Control is an automatic speed control system which is designed to allow the vehicle to hold a selected speed of approximately 30 MPH or higher—depending on engine limitations—thus increasing comfort and economy on turnpikes, and other non-congested highways.

- **TO OPERATE**—The Cruise Control engagement button is located in the end of the turn signal lever. Accelerate the vehicle to the desired speed and momentarily push in the engagement button, take your foot off the accelerator and this speed will be maintained.

- **TO RESET AT A FASTER SPEED**—Accelerate the vehicle to the desired higher speed, push in the engagement button fully and release slowly.

- **TO RESET AT A SLOWER SPEED**—Depress the engagement button fully and **HOLD**. Allow vehicle to decelerate. When vehicle reaches desired speed, release the engagement button slowly.

- **FOR PASSING**—You can increase your speed by depressing the accelerator pedal. When you remove your foot from the pedal,

the vehicle will slow down to the cruising speed set prior to the acceleration.

- **TO DISENGAGE**—Lightly apply the brake pedal to disengage system.

CAUTION

To help maintain vehicle control, do not use the Cruise Control when conditions are not suitable for maintaining a constant speed, such as in heavy or varying traffic, or in winding or slippery roads. With the Cruise Control engaged, removing foot from the accelerator pedal does not permit engine speeds to return to idle.

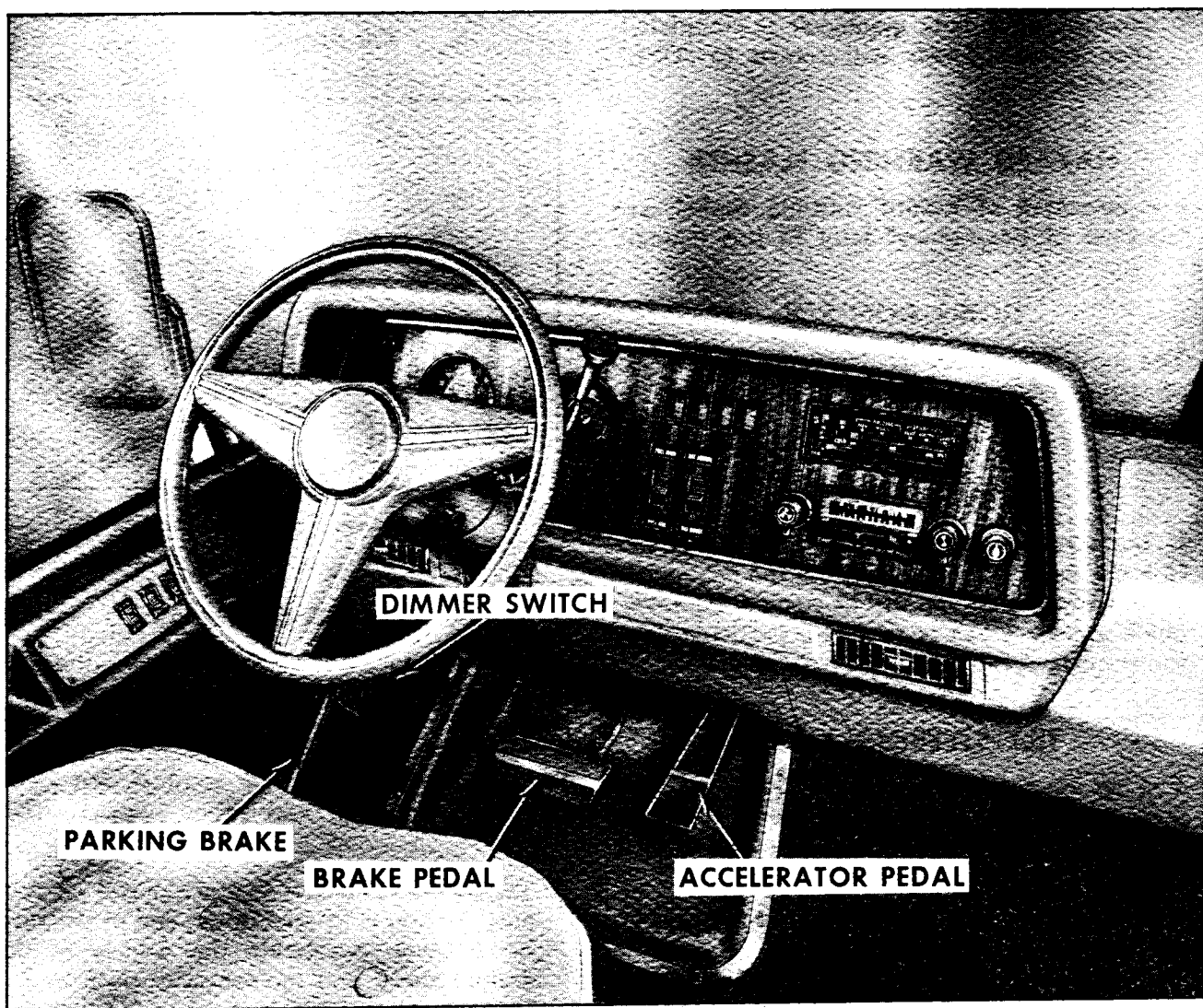

Vehicle Floor Controls

FLOOR CONTROLS

POWER BRAKE SYSTEM

This vehicle is equipped with a Dual Hydraulic Split System With Power Assist. It is also equipped with disc type brakes on the front wheels and drum type brakes on the tandem rear wheels.

NOTE: Operation of the brake system warning light is covered (on page 24) (in the section on "Instrument Panel and Controls").

CAUTION

Driving through water deep enough to wet the brakes may adversely affect brake performance so that the vehicle will not slow down at the usual rate, and may pull to the right or left. Applying the brakes lightly will indicate whether they have been so affected. To dry them quickly, lightly apply the brakes while maintaining a safe forward speed with an assured clear distance ahead and to the sides until brake performance returns to normal.

- On your vehicle, if power assist to the brakes is interrupted due to a stalled engine or a system malfunction, two or more brake applications can normally be made using reserve power.
- If the brake pedal is held down, the system is designed to bring the vehicle to a full stop on reserve power. However, the reserve power is partially depleted each time the brake pedal is applied and released. Do not pump brakes when brake power assist has been interrupted, except when necessary in order to maintain steering control on slippery surfaces.
- When reserve power is exhausted, the vehicle can still be stopped by applying greater force to the pedal.

SELF-ADJUSTING BRAKES

Brakes on this vehicle (except for the Parking Brake) are self-adjusting, designed to eliminate periodic adjustments.

Drum brake adjustment is made automatically as the brakes are applied while vehicle is moving backwards.

Disc brake adjustment is made automatically with each brake application.

- If excess brake pedal travel develops, drive alternately backward and forward several times and apply brakes firmly in each direction.
- See your dealer if normal pedal travel is not restored, or if there is a rapid increase in pedal travel, which could be a sign of other brake trouble. See your dealer also if adjustment of the parking brake is required.

NOTICE: "Riding the Brake" by resting your foot on the brake pedal when not intending to brake can cause abnormally high brake temperatures, excessive lining wear and possible damage to the brakes, in addition to wasting gasoline.

REMINDER: Front disc brakes have a built-in wear indicator that is designed to make a high frequency, squealing, or cricket-like warning sound when the linings are worn to where replacement is required. The sound will occur intermittently or continuously when wheels are rolling, but will disappear when the brake pedal is applied firmly. See also the various brake checks listed in the maintenance schedule folder.

PARKING BRAKE

- To set parking brake, fully pull up the handle located on the floor against the left wall, below the instrument panel.
- For increased holding power, first depress regular brake pedal with the right foot, and hold it while setting the parking brake with left hand.
- To release parking brake push the handle down.
- As a reminder, the "PARK BRAKE" reminder light is designed to come on whenever the parking brake control is not fully released, and the ignition is on.
- Never drive vehicle with parking brake set as this may overheat or otherwise damage rear brakes.

The amount of force required to apply parking brake can be adjusted by turning a tension adjustment knob located at the upper end of the lever. This also adjusts the degree of brake

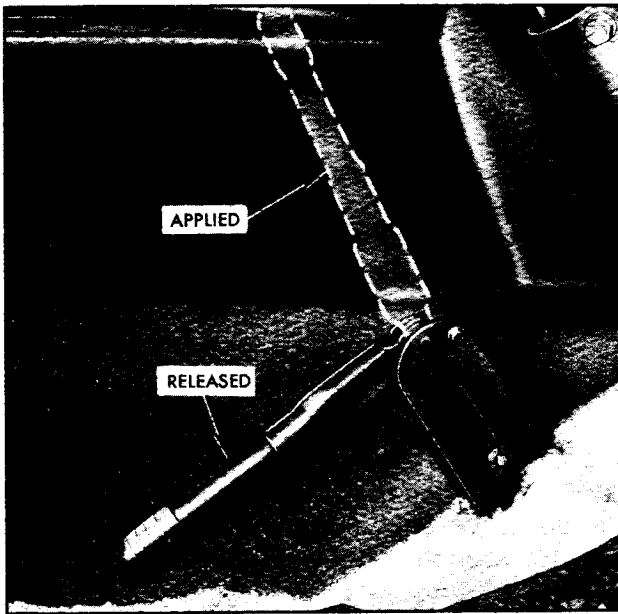

Parking Brake Control

application. The greater the force required at the lever the greater the degree of brake application.

NOTE: The parking brake should be set first whenever the driver's seat is left unattended.

If the vehicle is parked on a grade and the transmission is placed in "PARK" before the parking brake is set, the weight of the vehicle may exert so much force on the parking pawl in the transmission that the transmission selector lever cannot later be pulled out of "PARK." To

prevent this, the parking brake should be applied **BEFORE** moving the transmission selector lever to "PARK." When preparing to move the vehicle, the shift indicator should be moved out of the "PARK" position **BEFORE** releasing the parking brake. It is good driving practice to always set the parking brake first (when parking), and release the transmission from "PARK" first (when preparing to move the vehicle) at all times, even on the level. If "torque lock", as this condition is called, does occur, it may be necessary to have another vehicle nudge this vehicle up hill, to take some of the pressure off the transmission while the driver pulls on the transmission selector lever.

HEADLIGHT DIMMER SWITCH

To obtain high or low beam headlights, push the foot dimmer switch located on the floor to the left of the brake pedal. Each time the switch is depressed, the light beam changes. A headlamp beam indicator, on the face of the speedometer, is designed to light up when the headlights are on high beam.

HEADLIGHT "FLICKER"

The headlight circuits are protected by a circuit breaker in the light switch. An electrical overload on the breaker will cause the lights to "flicker" on and off, or in some cases to remain off. If this condition develops, have your headlight electrical circuit checked immediately.

INSTRUMENT PANEL AND CONTROLS

SPEEDOMETER AND ODOMETER

The speedometer indicates the forward speed of the vehicle in miles-per-hour and kilometers per hour. The odometer registers the accumulated mileage the vehicle has been driven. Also, located in the speedometer cluster are the turn signal indicators which show direction and proper operation of the turn signals, the high beam indicator light, and the shift indicator.

FUEL GAUGE

This gauge shows the approximate fuel level in the main tank when fuel selector switch is in the "FUEL MAIN" position, and the fuel level in the auxiliary tank when fuel selector switch

is in the "FUEL AUX" position. The pointer will indicate the correct positions only when the ignition is in the "ON" position.

Since both fuel tanks are interconnected, the indicated level is designed to read the same (with the switch in either position) until approximately 60% of the total fuel capacity has been used. See "Fuel Selector Switch" later in this section.

TEMPERATURE GAUGE

This gauge registers the temperature of the engine coolant. The center area of the water temperature gauge marks the normal operating range. However, if the needle moves beyond the center area marks into the "H" side or hot area

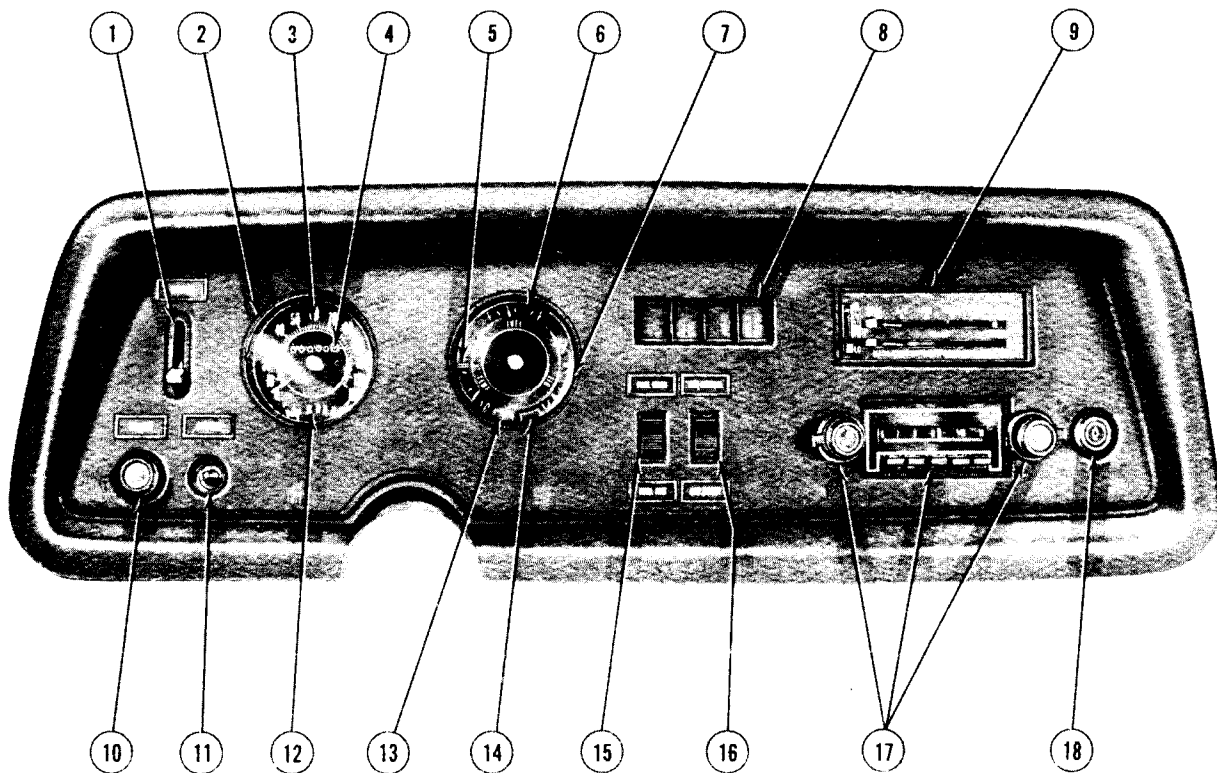

- | | | |
|-----------------------------|-------------------------|--------------------------------|
| 1. WINDSHIELD WIPER CONTROL | 7. OIL PRESSURE GAUGE | 13. GENERATOR LIGHT |
| 2. SPEEDOMETER | 8. WARNING LIGHTS | 14. BRAKE SYSTEM WARNING LIGHT |
| 3. HIGH BEAM INDICATOR | 9. HEATER/A.C. CONTROLS | 15. FUEL SELECTOR SWITCH |
| 4. ODOMETER | 10. LIGHT SWITCH | 16. BATTERY BOOST SWITCH |
| 5. TEMPERATURE GAUGE | 11. WINDSHIELD WASHER | 17. RADIO & CONTROLS |
| 6. FUEL GAUGE | 12. SHIFT INDICATOR | 18. CIGAR LIGHTER |

Instrument Panel

of the gauge, stop the engine as soon as possible, and remain stopped until the cause of the overheating is determined.

OIL PRESSURE GAUGE

This gauge registers engine oil pressure. The consistency of the oil in a cool engine will cause a high reading when the engine is first started. As the engine warms, the pressure will recede to normal. With the engine warmed up to normal operating temperature, minimum pressure at idle should be slightly above the "L" graduation (8 PSI). At normal operating speeds, minimum

pressure should be between the second and middle graduations (35 PSI). Should the pressure drop below these minimums, stop the engine immediately and check the cause of the low oil pressure. This could be the result of a dangerously low oil level in the crankcase. Driving the vehicle with low oil pressure can cause extensive engine damage.

CHARGING SYSTEM WARNING LIGHT

NOTE: If vehicle is equipped with a voltmeter it will not be equipped with a charging system warning light.

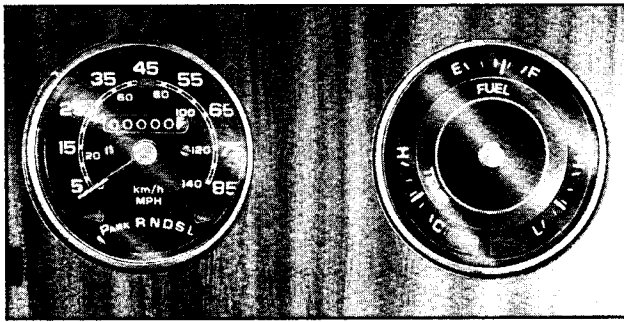

Speedometer and Gauge Clusters

Located to the right of the temperature gauge is the charging system warning light. A red light "GEN" will appear with the ignition key in the "ON" position and the engine not running. This light lets you know the warning signal is operational. Should the light fail to come on, see your Motorhome dealer. When the engine is started, the warning light should go out and remain out. If the light remains on when engine is running, have your dealer locate and correct the trouble as soon as possible.

BRAKE SYSTEM WARNING LIGHT

The service brake system is a dual system designed so that one part will provide some braking action in the event of loss of hydraulic pressure in the other part of the system. If the red warning light labelled "BRAKE" located to the left of the oil pressure gauge, comes on and stays on when the ignition is on and after the brakes have been firmly applied, it may indicate that there is a malfunction in one part of the brake system.

- The light is designed to come on during engine starting to verify that the bulb is operating properly.
- Have system repaired if light does not come on during check.
- This warning light is not a substitute for the visual check of brake fluid level required as part of normal maintenance.

IF LIGHT COMES ON:

- The service brake system is partially inoperative.

WHAT TO DO:

1. Pull off the road and stop, carefully—remembering that:
 - Stopping distances may be greater.
 - Greater pedal effort may be required.

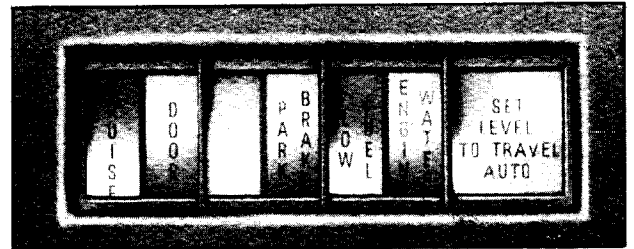

Warning Light Cluster

- Pedal travel may be greater.
 2. Try out brake operation by starting and stopping on shoulder of road — then:
- If you judge such operation to be safe, proceed cautiously at a safe speed to nearest service outlet for repair, or
- Have vehicle towed to dealer for repair.

Continued operation of the vehicle in this condition is dangerous.

TELL-TALE WARNING LIGHT CLUSTER

A cluster of indicator lights is located just to the left of the heater controls. These are designed to inform the driver of the status of certain systems or conditions of which he should be aware. Among these are:

- "CRUISE" (Optional Equipment) — This indicator is designed to glow GREEN whenever the Cruise Control System is engaged and working.
- "DOOR"—The door light is designed to warn the driver that the entrance door is not properly closed.
- "PARK BRAKE"—As a reminder, the "PARK BRAKE" brake reminder light is designed to glow whenever the parking brake control is not fully released and the ignition is on.
- "LOW FUEL" (Optional Light) — The low fuel warning light in your vehicle is designed to come on when the main tank has less than five gallons of fuel left and the fuel selector switch is in the "FUEL MAIN" position. If, at any point after this, the fuel selector switch is changed to "FUEL AUX" the "LOW FUEL" warning light will then go out and come on again when the fuel in the auxiliary tank goes below five gallons. At this point both fuel tanks of your vehicle are nearly depleted.
- "ENGINE WATER"—This indicator light is designed to warn the driver that the coolant

level in the radiator is abnormally low. (See "Servicing Details" later in this manual, before attempting to refill cooling system.)

- "SET LEVEL TO TRAVEL AUTO"—This light is designed to inform the driver that the optional Electro-Level System TRAVEL switch should be set to the "AUTO" position before driving the vehicle. (See "Electro-Level System" later in this section for additional details.)

VOLTMETER

The optional voltmeter is calibrated in volts and is divided into three segments. During operation, the indicator hand should remain in the center segment to indicate a normal battery condition. If indicator remains in left-hand segment, an undercharge condition exists. If hand remains in the right-hand segment, an overcharge condition exists. When indicator shows either an undercharge or overcharge condition, have your dealer check the battery and charging system at once.

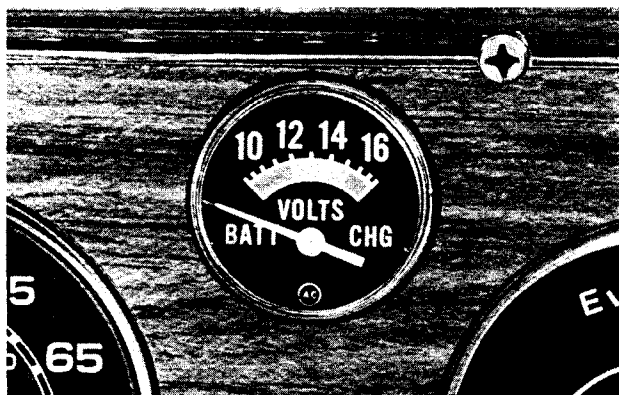

Voltmeter

HEADLIGHT SWITCH

The headlight switch serves four functions:

1. Pulling the switch half-way out provides parking lights, instrument panel lights, tail lights, side marker lights, and clearance and identification lights.

2. Pulling the switch all the way out provides all driving lights, — this includes headlights, plus those mentioned above.

3. To dim instrument panel lights, turn switch knob clockwise.

4. To operate the dome lights, turn switch knob fully counterclockwise.

WINDSHIELD WIPER LEVER

The windshield wipers are variable speed, and hydraulically powered. The lever control, on the left side of the instrument panel varies the speed of the wiper blades from stop ("DOWN" position) to fast (extreme "UP" position).

WINDSHIELD WASHERS

The windshield washers are controlled by the washer switch located under the windshield wiper lever. To operate the washers, turn the wipers to an ON position, then push down on the switch until the desired amount of washer fluid has been directed to the windshield.

- Check washer fluid level regularly — do it frequently when the weather is bad.
- Use a fluid such as GM OPTIKLEEN to prevent freezing damage, and to provide better cleaning.
- Do not use radiator anti-freeze in windshield washer; it could cause paint damage.

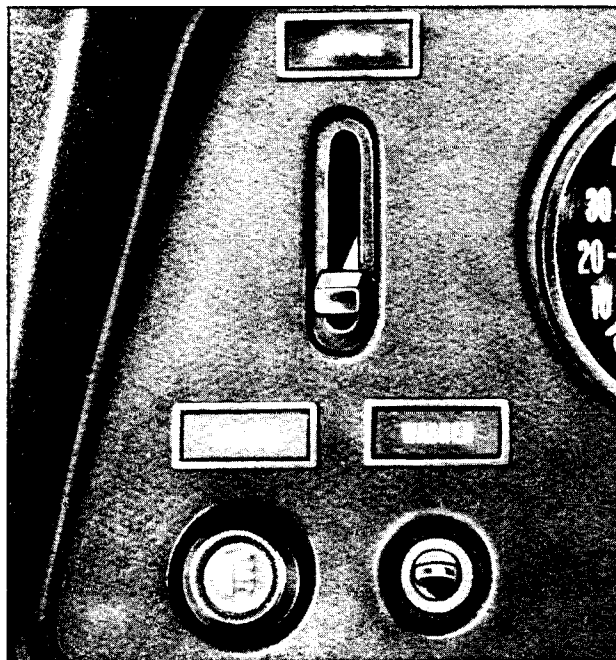

*Windshield Wiper, Washer,
and Headlight Controls*

- In cold weather, warm the windshield with defrosters before using washer — to help prevent icing that may seriously obscure vision.

FUEL SELECTOR SWITCH

The fuel selector switch, located below the warning light cluster, has two positions—"FUEL MAIN" and "FUEL AUX." This switch allows the driver to change the fuel pick-up and fuel gauge sending unit from the main tank, as it goes empty, to the auxiliary tank which will normally contain 7 to 9 gallons of fuel. It is recommended that any time the fuel system is filled, this switch be put in the "FUEL MAIN" position and left there until auxiliary fuel is needed.

BATTERY BOOST SWITCH

The GMC Dual Battery System provides power from two batteries to the vehicle's 12-volt electrical system either in combination or singularly. The components used to provide charging and/or switching are conventional, except for a diode assembly with which both batteries will receive charging current whenever the vehicle is running. The diode assembly has separate outputs to the two batteries and provides isolation between the batteries and their associated circuits whenever the engine is not running.

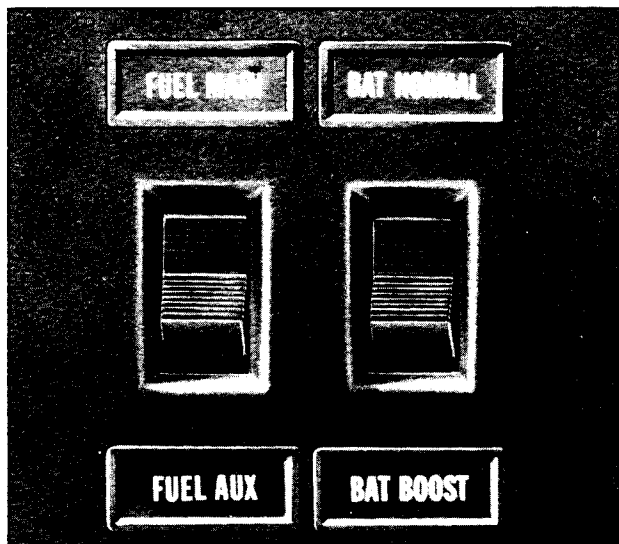

Fuel Tank and Battery Switches

The main battery (or automotive battery) supplies power to the chassis circuit; i.e., engine, external lights, etc. The auxiliary battery (living area battery) powers the Motorhome living area; i.e., internal lights, refrigerator, etc.

When additional power is needed for either battery circuit, hold switch momentarily in

"BAT BOOST" position. After use, switch is designed to return to the "BAT NORMAL" position.

NOTE: If the battery boost switch is retained in the "BAT BOOST" position for extended periods this can result in both batteries being discharged.

The auxiliary (living area) battery will recharge itself whenever the motor generator is running, or whenever your Motorhome is connected to an external power source (see page 30), in addition to being recharged while the vehicle's engine is running.

CIGAR-CIGARETTE LIGHTER

Push the lighter in all the way to operate. When it is heated sufficiently to use, it is designed to "snap" back to normal position with noticeable sound. Avoid holding the lighter in by hand while it is heating.

For added safety, the cigar-cigarette lighter has a heat-sensitive terminal which is designed to melt and break the circuit if the lighter becomes overheated.

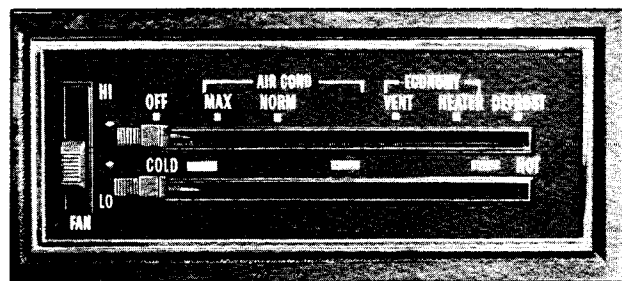

Automotive Heating and Air Conditioner Controls

AUTOMOTIVE HEATING AND AIR CONDITIONING SYSTEM

The Automotive Heating and Air Conditioning System offers year-round driving comfort. In addition to providing circulation of cool air during hot weather, the system can provide warm air in cold weather and dehumidify outside air in humid weather. Another feature of the system is continuous low-speed operation of the heater and air conditioner blower, resulting in an uninterrupted supply of outside air flow into the vehicle whenever the ignition switch is on. The following portion of this manual provides operating instructions for obtaining heating and

cooling comfort. (See **Engine Exhaust Gas Caution** at the beginning of this section).

AIR OUTLETS

Air is directed through a combination of the heater floor vent, the adjustable outlets in the instrument panel, and the defroster vents at the base of the windshield. Each instrument panel outlet can be adjusted to divert air throughout the driver and front passenger area. Note the driver's left-hand outlet can be closed.

CONTROLS

The heater and air conditioner controls are located on the instrument panel to the right of the steering column. They consist of a fan switch and two sliding levers. The upper sliding lever selects the source of air and the lower one determines the temperature of air.

FOR COOLING—

Move the top lever to either of the two "AIR COND" positions, "MAX" or "NORM." Adjust the bottom (temperature) lever to the desired air temperature and adjust the fan switch to meet the air flow requirements. For maximum cooling or quick cool down in hot, humid climates, or during extended idle conditions — move the top lever to "MAX" and the lower lever to "COLD." This provides 80% recirculated air and 20% outside air at high blower speed independent of fan speed switch setting. Moving the top lever to "NORM" provides 100% outside air. Blower speed is determined by the fan switch setting. The temperature of the dehumidified air can be controlled in all positions by moving the lower lever.

NOTE: A protective device installed on all vehicles will turn the compressor off should the system leak refrigerant, thus avoiding possible costly repair and inconvenience to the owner.

FOR VENTILATING—

With the top lever in the "VENT" position, 100% outside air enters the vehicle through the air conditioning and heater outlets. Heat may be added to the vent air by adjusting the bottom lever. Any one of the four blower speeds may be selected.

FOR HEATING—

Move the top lever to "HEATER" to bring heated air into the vehicle of which 90% is

through the heater outlet and 10% through the defroster outlets. The bottom lever should be positioned for the desired air temperature and the fan switch moved for the proper air flow.

FOR DEFROSTING

Moving the top lever to "DEFROST" brings 100% outside air into the vehicle of which 90% is through the defroster outlets and 10% through the heater outlet. Adjusting the bottom lever gives the desired temperature and moving the fan switch produces the right air volume. The air conditioner compressor engages automatically at outside temperatures above freezing.

- Clear windshield, rear window, outside mirrors, and all side windows of ice and snow before driving vehicle.
- Operate blower on "HI" for a few seconds before moving the vehicle, to help clear the air intake of snow to reduce the possibility of fogging on inside of windshield.

TO TURN SYSTEM OFF—

Move the top lever to the "OFF" position. The blower will continue to operate at low speed whenever the ignition switch is on, bringing outside air into the vehicle through the heater outlet.

FOR ECONOMY—

With the top lever in "OFF" or "ECONOMY" modes ("VENT" and "HEATER"), the air conditioning compressor does not operate and the reduced engine load can result in improved fuel economy. Use the "VENT" position in mild temperatures, 30 to 70°F. (–1 to 21°C.), when cooling requirements are not great, and the "HEATER" position for most heating requirements to maximize fuel economy. If comfort is not maintained, or if windows tend to fog, return the top lever to "NORM," or "DEFROST" position.

NOTE: The air conditioner compressor will operate in "MAX," "NORM," and "DEFROST" when the outside temperature is above freezing. Keep the vehicle windows closed for best operation of the air conditioner and heater systems.

RADIOS AND TAPE DECK

PUSH BUTTON "AM" RADIO

The "ON-OFF" switch is on the left-hand center knob with the volume control. The left-hand outside knob varies the tone response of

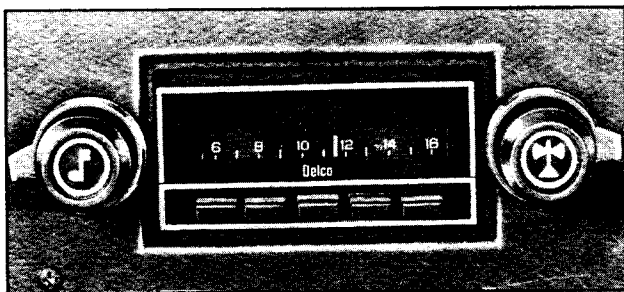

Push Button AM Radio

the receiver. The right-hand center knob is used to select the station desired. The right-hand outside knob adjusts the volume of front and rear speakers.

In addition to the manual controls, this radio provides five push buttons with which to automatically select pre-set stations. To pre-set, pull the push button "out" as far as it will go, tune in the desired station manually, and then push the button "in."

Repeat this operation for each push button.



AM-FM Stereo Radio with Tape Deck (Tape Removed)

AM-FM RADIO

In addition to providing standard AM reception, this set permits you to receive clear static-free FM broadcasts. Move the slide bar, above the push buttons to the right or left to select AM or FM reception. All other controls remain the same as described for push button radios. FM broadcasts may be received as far as 25 miles from the sending station, depending on the power of the station and the existing terrain. In fringe areas, it may be possible to retune the radio slightly to maintain peak reception. If not, retune to a closer or stronger FM station or switch to AM operation. Push buttons may be set for both AM or FM stations as follows:

- Place slide bar in AM position.
- Pull push button out as far as it will go, tune in desired AM station manually and then push button in to LOCK-IN position.

- Repeat for each remaining push button.
- Place slide bar in FM position and repeat procedures outlined for AM band setting.

IMPORTANT: Bands should not be changed if push button is unlocked or radio may be damaged.

ANTENNA

The radio antenna is mounted on top of the vehicle. If necessary, adjustments for maximum antenna effectiveness on AM can be made by your authorized GMC Motorhome dealer.



AM-FM Stereo Radio with Tape Deck (Tape Installed)

STEREO RADIO

Stereo Receivers permit FM stereo reception to turn the set on and off and for station selection. For most pleasing stereo effect, the speakers are criss-crossed, with the left front and right rear speakers reproducing the left channel, and with the AM-FM radio. Radio controls are used the opposite speakers reproducing the right channel. Balancing the speakers is not required as this adjustment has been made at the factory. Should it become necessary to make this adjustment, see your GMC Motorhome dealer. The indicator light will be on when the radio is tuned to an FM stereo station. Most broadcasts on such stations will be in stereo.

To Tune Your Stereo Radio

- Tune radio to an FM Stereo station (one which makes the indicator light come on with a steady glow).
- Tune the lever behind the station selector knob until volume from front and rear speakers sounds equal.
- Regulate volume and tone controls as required.

STEREO TAPE SYSTEM

The optional Stereo Tape Player provides prerecorded stereo programs for your enjoyment.

To play, insert cartridge through tape door with label side up and open end in first. Tape will play through all four programs in succession, then replay in same sequence. Balancing the speakers is not required as this adjustment has been made at the factory. Should it become necessary to make this adjustment, see your GMC Motorhome dealer.

1. Rotate fader control until volume from front and rear speakers sounds equal.
2. Regulate volume control and tone controls as desired.
3. To change program track, push in volume control knob and release; player will index to next track.
4. To remove tape cartridge from player, simply pull cartridge out of player.

Cleaning and Care

Every 100 hours of operation, or if tape slips and runs slowly, the capstan (revolving metal post), head and tape guide should be cleaned with a cotton-tipped swab moistened with alcohol (do not use carbon tetrachloride). To clean the capstan, trip the "ON-OFF" switch at the rear of the receptacle with your finger and hold the swab against the rotating capstan.

IMPORTANT: When tape player is not in use, remove the cartridge and store it in a cool, dry place out of direct sunlight. If the cartridge is not removed, the radio may be inoperative and possible roller damage to the tape unit could occur.

AM-FM STEREO RADIO WITH TAPE PLAYER AND CB TRANSCEIVER

The AM-FM stereo radio with tape player and CB (Citizens Band) transceiver allows the operator to play the radio or tape player and to transmit and receive communications on any one of 40 channels.

A four speaker system is used for radio, tape player, and CB transceiver. The controls for the unit are mounted on the radio face and CB microphone.

IMPORTANT: Before transmitting with your CB transceiver, be sure you have fulfilled the following:

1. Operation of this equipment requires a valid station license issued by the FCC (Federal Communications Commission). By filling out the temporary permit

(Form 555-B) that came with your transceiver you can transmit with your equipment until you have received your license. License application is to be made on FCC Form 505, available from your nearest FCC field office. Copies of these forms are included with your new transceiver.

2. You are required to maintain a current copy of Part 95 Citizens Radio Service, the FCC rules and regulations, as a part of your station records. Copies are available from: Superintendent of Documents, GPO, Washington, D.C. 20402.
3. Your station license is to be posted in accordance with paragraph 95-101 of the FCC rules and an executed Transmitter Identification Card (FCC Form 452-G) is to be attached to each transmitter. A copy of this form is included with your new transceiver.
4. Never operate the transmitter unless the CB antenna is connected. To avoid damage to the CB transceiver, do not attempt to connect the entertainment radio antenna to it.

NOTE: For details on operation of a CB transceiver in foreign countries, refer to Operation in Foreign Countries in the **BEFORE DRIVING YOUR MOTORHOME** section earlier in this manual.

Control Function

NOTE: The following is a brief explanation of each control on the AM-FM Stereo Radio with Tape Player and CB Transceiver. (Refer to illustration for control location).

1. *Microphone*—Hand-held instrument containing channel selector, channel indicator, and transmitter control.
2. *Channel Lock*—Prevents changing channels, unless desired. With switch in the UP position, channel selector is locked. If switch is in the DOWN position channels may be selected as desired.
3. *DOWN Channel Selector*—Depressing this button will change the channel as shown on the CB channel indicator. Channel will continue to change as long as button is depressed.
4. *UP Channel Selector*—Depressing this button will change the channel as shown on the CB channel indicator. Channel will

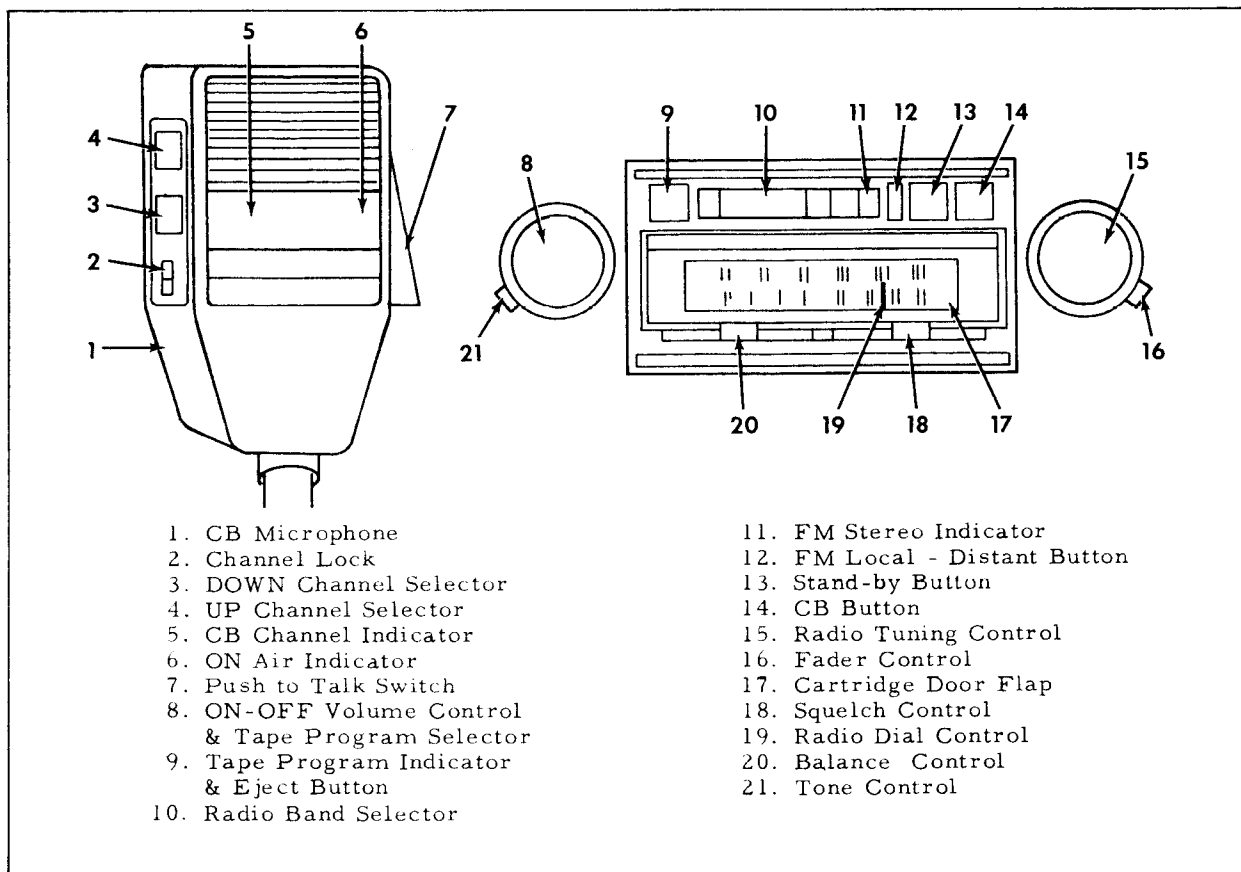

AM-FM Stereo Radio with Tape Player and CB Transceiver

continue to change as long as button is depressed.

5. **CB Channel Indicator**—Digital read-out of CB channel selected.
6. **ON Air Indicator**—The light is an output indicator device which lights up when the transmitter is activated.
7. **Push to Talk Switch**—The CB receiver and transmitter are controlled by this switch. Press the switch in to activate the transmitter. Release the switch to receive CB signals.
8. **ON-OFF Volume Control & Tape Program Selector**—To provide power to the unit, it is necessary to turn this knob clockwise until a “click” is heard. To increase volume, continue rotating knob to desired level. Tape program selector switch is combined with volume control. Push this knob for desired tape program.
9. **Tape Program Indicator & Eject Button**—Tape program indicator shows which program (channel) is being played. The indicator is also the EJECT button which

allows easy removal of the tape cartridge.

10. **Radio Band Selector**—To select either AM or FM broadcast band, move this selector to the left (FM) or to the right (AM).
11. **FM Stereo Indicator**—This light will automatically light indicating you have turned to an FM stereo station.
12. **FM Local-Distant Button**—This control is used for limiting or improving FM radio reception when driving through a strong or weak reception area.
13. **ST BY Button**—By pressing the button you can receive “call-in” CB signals by an automatic break-in circuit even though the radio or tape player is in operation.
14. **CB Button**—By pressing this button the radio or tape player is cut off and the unit operates like a conventional CB transceiver.
15. **Radio Tuning Control**—This control allows manual selection of radio stations. Simply turn knob to right or left for station selection.

16. *Fader Control*—Rotate fader control until volume of front to rear speakers is as desired.
17. *Cartridge Door Flap*—Simply insert the tape cartridge by pushing this flap upwards.
18. *Squelch Control*—The squelch control silences the CB receiver's noise when signals are not being received.
19. *Radio Dial Control*—The pointer will move along the dial when changing stations.
20. *Balance Control*—A manual balancing, of the left channel (left front and right rear speakers) and the right channel (opposite speakers) can be adjusted as desired.
21. *Tone Control*—This control allows selection of "Bass" or "Treble" tone. Rotate control as desired.

CB Transceiver Operation

1. Set the SQUELCH control all the way to the left.
2. Turn the VOLUME control knob clockwise until a click is heard. Continue turning until a rushing noise is heard on speakers.
3. Adjust tone, balance and fader control for desired sound.
4. Using UP or DOWN channel selector, obtain desired channel and LOCK. Channel number is indicated on digital readout on microphone.
5. Adjust SQUELCH control to the right until CB receiver is silenced. Careful adjustment is necessary because setting too far to the right will not allow weaker signals to be received.
6. To transmit, depress the *press to talk* button on the microphone. The ON air light will light up. Hold the microphone 1-2 inches away from your mouth and speak in a normal voice. Release the button to receive CB signals.
7. By depressing the ST-BY button while you are listening to radio or tape, you can receive CB signals which will automatically break-in in accordance with the squelch level having been preset by the SQUELCH CONTROL. If you wish to answer that CB signal, depress the CB

button and talk into the Microphone depressing P.T.T. switch. In the meantime, you may leave the ST-BY button as it is.

8. Serious attention is definitely needed for setting the SQUELCH CONTROL in case of ST-BY reception. If you set it too far to the right, only very strong signals can break-in. Consequently, you might miss the call-in signal. On the contrary, setting it too far to the left will cause frequent break-ins by very weak signals or even noise.
9. If you set the SQUELCH control all the way to the left (minimum squelch) while the ST-BY button is being depressed, radio or tape might be cut off, even though there will be no call-in signals. Do not be concerned as there is nothing wrong with this function. So long as you do not depress the ST-BY button, the SQUELCH control has nothing to do with the radio or tape sound.

On the air operating techniques and allowable communications are prescribed in the FCC rules. We strongly recommend that you do not unknowingly violate these rules.

AM-FM, FM Stereo Radio Operation

1. Release the CB button and ST-BY button to unlock.
2. Turn the unit on.
3. Adjust the VOLUME control, TONE control and BALANCE control as desired.
4. Select the desired broadcast band (AM or FM) by sliding the BAND SELECTOR.
5. Rotate the RADIO TUNING CONTROL knob to tune in the desired station.
6. When an FM stereo station is being received, the FM STEREO INDICATOR automatically illuminates.
7. In FM reception, if the FM signal is too strong (you are near a local broadcast antenna) and reception is very strong and distorted, press the LOCAL-DX switch in (LOCAL POSITION). When driving in a poor reception area or if you are tuned to a distant station, push this switch out (DISTANT POSITION). This will allow maximum signal reception in all areas.

NOTE: If this switch is left in local position, weak stations will not be received. If a distant or weak

station is desired, always keep this switch out (DISTANT POSITION) when leaving strong signal areas. This function will only affect FM radio broadcasts. It has no effect on AM broadcast or CB station reception.

Stereo Tape Player Operation

1. Release the CB button and ST-BY button.
2. Turn the unit on.
3. Insert the tape cartridge pushing the flip-up door upward.
4. Adjust VOLUME, TONE and BALANCE.
5. TAPE PROGRAM SELECTOR combined with VOLUME control is used for the manual change of the desired program (channel). Push this knob for use. Otherwise, the programs are automatically changed in sequence.
6. Push EJECT BUTTON (combined with TAPE PROGRAM INDICATOR) for easy removal of tape cartridge. Pushing this button also has the effect of switching over to the radio reception.

NOTE: Once the tape cartridge is disengaged by "EJECT", take the cartridge completely out from the slot and then insert it into the slot to play it again. Otherwise, the cartridge lock mechanism does not work. The tape cartridge is to be removed from the unit whenever the unit is not in use.

MOBILE RADIO TRANSMITTERS

Mobile radio transmitting equipment is subject to Federal Communications Commission

regulations and must be installed by a qualified radio technician. The specific installation instructions for radio transmitters will vary depending upon the radio equipment used. Mobile telephone equipment installed by your local telephone company, citizens band radios and electronic garage door openers will not adversely affect vehicle operation. In the event any other type of mobile radio transmitter is to be installed, consideration must be given to any possible adverse effect on vehicle operation.

STANDARD REAR SUSPENSION SYSTEM

The standard rear suspension system utilizes an automatic leveling feature that maintains a constant ride height at the rear tandem suspension. Note, information pertaining to "Emergency Operation" and "Maintenance" is the same as given under the following heading—"ELECTRO-LEVEL SYSTEM."

ELECTRO-LEVEL SYSTEM

The optional Electro-Level System provides the ability to level the vehicle at campsite or parking area where the surface is not level. This system can override the automatic leveling feature that maintains a constant ride height at the rear tandem suspension. The Electro-Level System can raise or lower the rear of the vehicle approximately 4 inches from normal ride height.

The Electro-Level control panel is located to the left of the driver, below the window.



Electro-Level System Control Panel

NORMAL OPERATION

The controls consist of three rocker switches that function to automatically or manually level the vehicle. The center rocker switch (TRAVEL) is used for a travel or hold mode, and the two outer rocker switches (RAISE-LOWER) are used to raise or lower the vehicle.

Driving

A reminder light in the dash panel is designed to light any time the engine is running and the transmission selector lever is moved to "D" (Drive Range). The normal position for the RAISE-LOWER switches should be placed in "OFF." The TRAVEL switch should be moved to "AUTO" for the first five minutes, if vehicle has been in a raised or lowered position. Then move the switch to "HOLD" after ride height is achieved.

It is not necessary to move the TRAVEL switch to "AUTO" if vehicle has not been leveled at a campsite or vehicle load has not changed significantly.

NOTE: The "HOLD" position is to be used for normal highway driving, when the vehicle is in operation. This allows the vehicle to maintain a designed ride height and eliminates unnecessary operation of the air compressor.

Campsite or Parking Area

The two RAISE-LOWER switches may be used as necessary to raise or lower the vehicle. When using Electro-Level at a campsite the vehicle engine need not be running to operate the

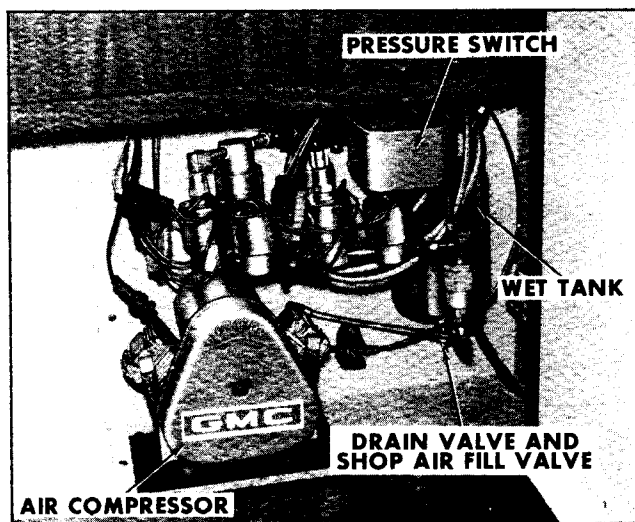

Rear Suspension Control Components (ZEO 6581)

system, however, the ignition switch must be in the "ON" or "ACCESSORY" position.

"RAISE"—With a rocker switch in this position the appropriate side of the vehicle will raise rear of vehicle to any desired position, up to a maximum of approximately 4 inches above normal ride height. When desired height is reached, return rocker switch to "OFF" position.

"LOWER"—With a rocker switch in this position the appropriate side of the vehicle will lower a maximum of approximately 4 inches below the normal ride height. In order to maintain a de-

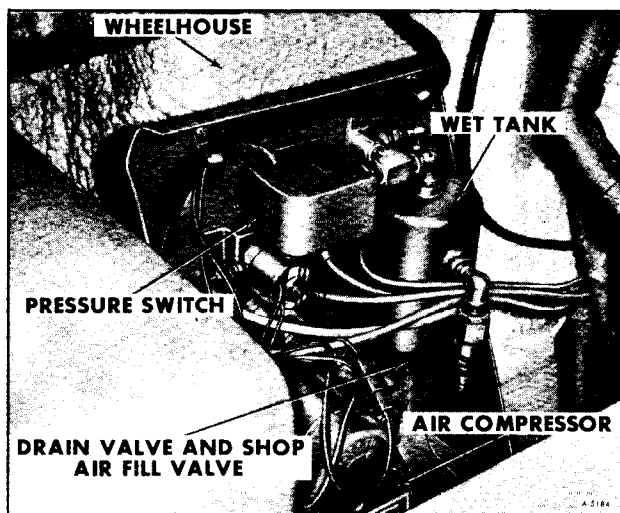

Rear Suspension Control Components (ZEO 6584)

sired height, return rocker switch to "OFF" position.

NOTE: It is possible that the air compressor may operate for a short period when a rocker switch is in "LOWER" position.

IMPORTANT: When both sides of the vehicle have been leveled be sure the TRAVEL switch is moved to "HOLD" and turn ignition switch to "OFF".

A glass of water or a bubble type level when placed in a normally level location inside the vehicle can be used to assist in determining the desired level condition.

OFF-ROAD OPERATION

In order to gain maximum ground clearance both RAISE-LOWER switches should be placed in the "RAISE" position. It is recommended that a speed of 15 MPH should not be exceeded since

the air suspension in this position has maximum pressure supplied.

EMERGENCY OPERATION

In the event of total air loss for any reason, the vehicle may be driven at a speed of 5-15 MPH (depending on road surface) with the rear of the vehicle in the fully "DOWN" position. Care should be exercised since ground clearance at the rear will be at a minimum. Vehicle should be taken to nearest dealer.

Depending on the type of failure, it may be possible to add air to the rear suspension wet tank (shop air fill valve located on tank—see illustration) by filling reservoir at a local gas station. (DO NOT EXCEED 120 PSI.) Be sure the engine is running or the ignition switch is turned

to "ON" or "ACCESSORY" position, and the outer rocker switches in "RAISE" position until vehicle is leveled. Then move RAISE - LOWER switches to "OFF" and TRAVEL switch to "HOLD".

MAINTENANCE

No routine maintenance is required on the Electro-Level System other than draining moisture in the wet tank and cleaning the air compressor filter. Refer to SERVICE AND MAINTENANCE section later in this manual for "REAR SUSPENSION" maintenance details.

GMC MOTORHOME NOTES

OPERATION OF LIVING AREA FACILITIES

LIVING AREA FACILITIES CAUTION (CARBON MONOXIDE)

Carbon monoxide is a colorless and odorless gas and can cause unconsciousness and is potentially lethal in high concentrations.

Whenever operating the optional motor generator it is essential the left rear window of the vehicle be kept closed to prevent possible entry of motor generator exhaust gases into vehicle. Inspect the motor generator exhaust system at vehicle lubrication intervals or when a change is noticed in the sound, alignment, or appearance of the exhaust system or if it is damaged. Do not run motor generator in a confined area, such as a garage.

The Motorhome is equipped with LP gas operated range/oven, furnace, and may be equipped with an optional gas/electric refrigerator. These components generate carbon monoxide when operated and should be used only if there is adequate ventilation. Whenever operating range or oven(s) be sure power range hood fan above range is turned on, and operating. Also see that all exterior vents on Motorhome for power range hood, furnace, and gas/electric refrigerator are open and kept clean and free from clogging materials such as snow, leaves, dirt, grass, etc.

See ENGINE EXHAUST CAUTION (Carbon monoxide) page 15.

LIVING AREA ELECTRICAL SYSTEM

GENERAL INFORMATION

The Motorhome living area electrical system is designed for utmost convenience. It is capable of supplying the vehicle with power from at least two sources (three, if equipped with a motor generator).

All electrical components except the water heater, the roof mounted air conditioner (if equipped), and the plug receptacles, are powered by the 12-volt auxiliary (living area) battery which is automatically charged each time the vehicle's engine is running.

In addition, your vehicle may be plugged into a 120-volt external power source which will supply 120-volt power throughout the living area, power all 12-volt components through a power converter, and charge the living area battery.

If your Motorhome is equipped with a motor generator, the vehicle will be supplied with 120-volt and 12-volt power throughout the living

area, and recharge the living area battery, any time the motor generator is running.

IMPORTANT: The living area battery should be used for short term use only. When the vehicle's engine is not running it is recommended that the vehicle be connected to an external power source or, the (optional) motor generator be operated, whenever possible. Before connecting to an external power source or operating the motor generator be sure to read the following pages.

CAUTION

To help avoid a potentially lethal situation, do not connect any 120-volt appliances or any other equipment outside the Motorhome through use of an extension cord, or directly, to an interior receptacle in Model ZEO 6581. The interior receptacles in this model are not ground-fault protected.

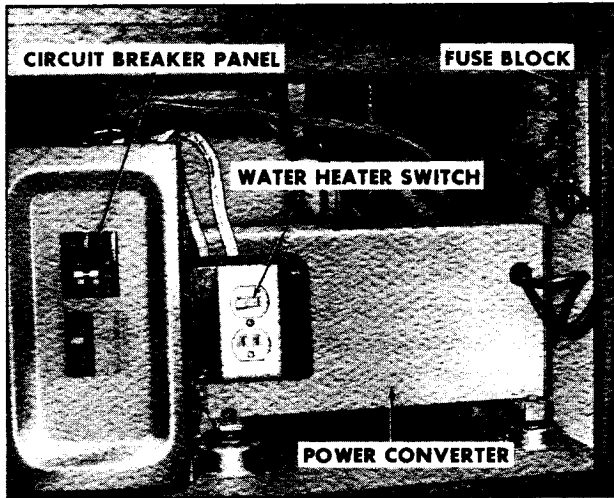

Living Area Electrical Compartment (ZEO 6581)

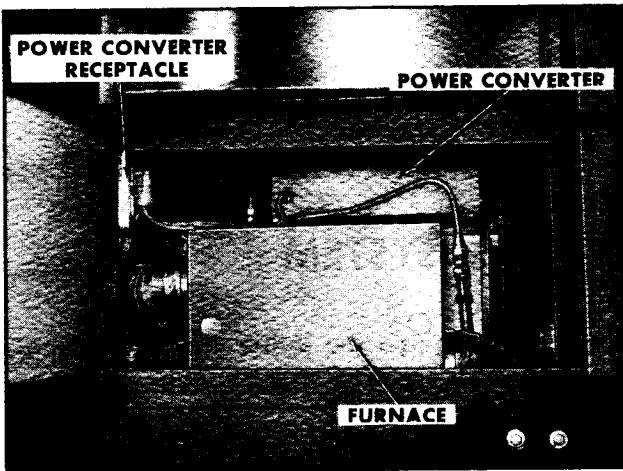

Converter Location (ZEO 6584)

120-VOLT TO 12-VOLT CONVERTER AND BATTERY CHARGER

The Motorhome is equipped with a 45 amp 120-volt to 12-volt power converter. Its function is to take a portion of the 120-volt current, that is received when the vehicle is plugged into an external power source, or when the motor generator is running, and change it to 12-volts which powers much of the Motorhome. It will also charge the auxiliary (living area) battery any time 120-volt current is being received. The unit is located in the living area electrical compartment, next to the hall closet in Model ZEO 6581. In Model ZEO 6584, the unit is located beneath the oven, behind the furnace.

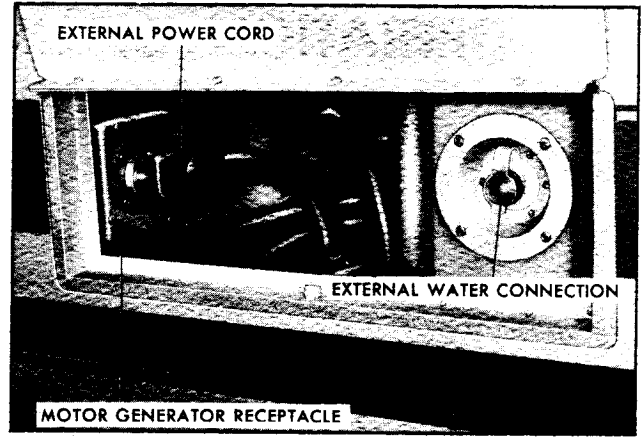

External Utilities Compartment

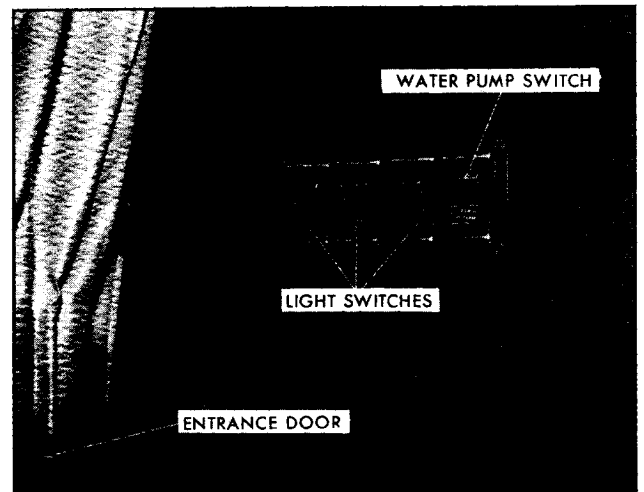

Light Switch Panel (Typical)

CAUTION

Do not use living area electrical compartment as a storage area. The converter must have a free flow of air through and around the unit. If air flow is restricted, the converter could overheat which could result in malfunction and permanent damage. Do not let the unit get wet, but do keep it as clean as possible to help assure its long life. The converter can be cleaned with low pressure air (30 PSI maximum) if necessary.

EXTERNAL POWER

The external utilities compartment located in the left side of the Motorhome contains the 21-foot power cord used for external power connections.

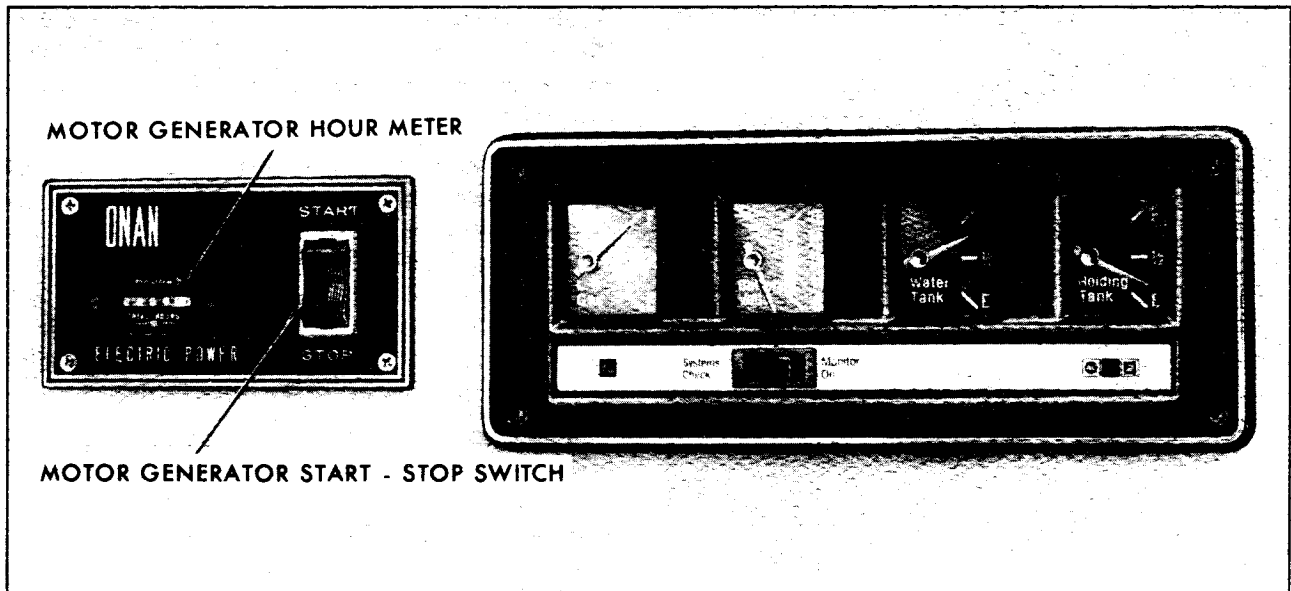

Monitor Panel and Onan Motor Generator Switch

To make an external power connection, remove the cord from the compartment and plug it into a suitable power receptacle. All internal switching will take place automatically. When disconnecting from an external power source the power cord should be plugged into the motor generator receptacle within the external utilities compartment. This connects the motor generator to the Motorhome electrical system. If the vehicle is not equipped with a motor generator simply coil the power cord neatly within the external utilities compartment.

Your Motorhome's external power cord contains two 120-volt circuits, rated to carry 40 amperes each. The electrical connection to be used must be suitable for these requirements. If the receptacle is designed to mate with the prongs on the power cord plug, the electrical connection can be expected to CARRY RATED LOAD. It is recommended that the power cord not be plugged in if the receptacle is not designed for your plug. In this event you can use your optional motor generator.

CAUTION

If the available power supply is other than 120/240-volt, 60 cycle rating, or is not properly grounded, it is essential that no attempt be made to plug in. Your Motorhome's electrical system is not designed for such electrical systems and connection could result in serious personal injury or property damage.

LIGHTING SYSTEM

All the lighting throughout the Motorhome is on the 12-volt system. Some of these lights may contain a three-way switch which allows a choice in the amount of light given off. The switches to these lights are located on the light fixture itself.

A panel of light switches is located near the entrance door. These switches operate the porch light, the kitchen light, the aisle floor light, and the water pump switch.

MONITOR PANEL

The Motorhome Monitor Panel is a series of four gauges located at eye level in the living area. Included are:

- **L.P. GAS**—This gauge is designed to indicate the amount of liquid petroleum gas remaining in the tank.
- **BATTERY VOLTS**—During operation, the indicator should remain in the center segment of the dial to indicate normal battery condition. If the indicator shows less than 11-volts, an under-charge condition exists in the living area battery and a recharge is required.
- **WATER TANK**—This gauge is designed to indicate the amount of water remaining in the living area water tank.

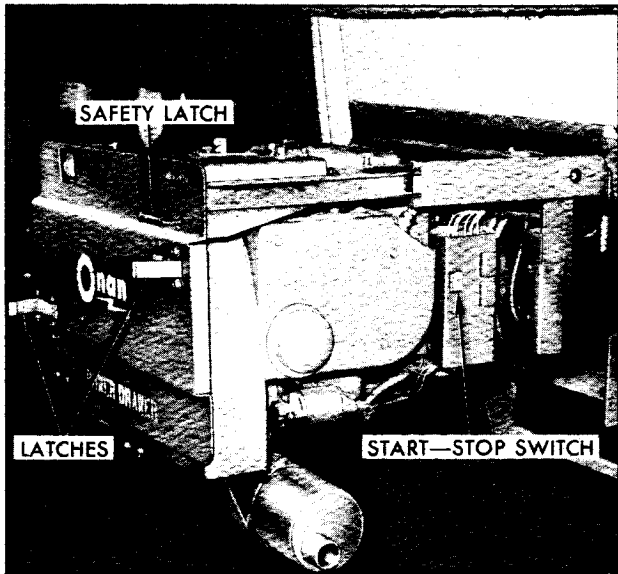

Onan Motor Generator

- **HOLDING TANK**—This is designed to indicate content level in the holding tank. Never allow this gauge to reach the “FULL” mark. If the holding tank is overfilled the overflow will back up through the bathroom shower drain.

These gauges are activated by a “ROCKER” switch located on the face of the panel. This switch has three positions; “ON,” “OFF,” and “MOMENTARY ON.” An indicator light glows when gauges are operating.

MOTOR GENERATOR

IMPORTANT: Before operating motor generator see the carbon monoxide caution at the beginning of this section.

The motor generator will allow operation of all 120-volt appliances without an external power connection, thus allowing the vehicle to be independent of an external power source. The motor generator is located in an exterior compartment in the left rear corner of the vehicle.

The Onan unit is mounted on slides and can be pulled out like a drawer for ease in servicing the unit. To slide out the unit depress the buttons on the two latches. Then pull up on safety latch in upper right-hand corner and pull unit out.

OPERATING INSTRUCTIONS

The unit can be started from inside the Motorhome by using the remote switch. The

Onan remote switch is located at eye level on the side of the refrigerator. A START-STOP switch is also located on the right side of the generator.

Before starting the motor generator the external power cord must be plugged into the motor generator receptacle. Both of these components are located in the external utilities compartment on the left side of the vehicle. Be sure the crankcase has been filled with oil to the “F” full mark on the dipstick. Check oil only when the motor generator is not operating.

The remote START-STOP switch is a three-position rocker switch. By pressing the top half of the switch the starter on the motor generator will be activated, hold in the switch until the unit is started. The switch should then be released. When the motor generator is running the small amber light next to the switch will be lit. To stop the unit depress the bottom half of the switch, and hold in until the unit comes to a full stop. The START-STOP switch on the unit itself operates in a similar manner.

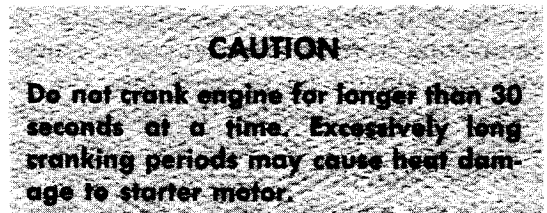

IMPORTANT: If the motor generator has been running with a load connected, disconnect the load and allow it to run for a few minutes (with no-load connected) before pushing STOP button.

The circuit breaker on top of the unit will trip when the demand for electricity in amperes exceeds the motor generators capabilities. If the circuit breaker does trip, remove part of the electrical load and reset the breaker.

HOUR METER

Located to the left of the START-STOP switch is the HOUR METER. The HOUR-METER indicates total amount of hours motor generator has operated. This gauge will aid in determining when the motor generator should receive periodic inspections, maintenance and service parts replacements in conjunction with the Maintenance Schedule folder. The Maintenance Schedule folder includes Onan Motor Generator Maintenance.

HIGH TEMPERATURE OPERATION

Make sure that nothing obstructs air flow to and from the unit.

Motor Generator housing should be unaltered and undamaged. Keep cooling fins on Onan unit clean.

LOW TEMPERATURE OPERATION

1. Use correct SAE No. Oil for temperature conditions (see **SERVICE AND MAINTENANCE** section later in this manual to determine proper viscosity oil). Change oil only when engine is warm.

2. Keep fuel system clean and battery in well charged condition.

LOW OIL LEVEL

If motor generator suddenly stops during a tight turn or sudden stop of the Motorhome, the cause is most likely a low oil level. The unit is designed to shut-down when oil level is abnormally low. Before attempting to restart unit, check oil level and correct as necessary.

DUSTY AND DIRTY OPERATION

1. Keep unit clean. Keep cooling system clean.

2. Service air cleaner as required.

3. Change crankcase oil and filter more often than normal.

4. Keep governor linkage on Onan unit clean.

FUEL

The motor generator's fuel is supplied from the vehicle's main fuel tank.

NOTE: The motor generator may be operated while the vehicle is underway. However, the vehicle's gasoline supply will be depleted at a faster rate.

EXTERIOR RECEPTACLE

The optional exterior receptacle includes a ground-fault interrupter circuit breaker designed to protect you from the hazards of line to ground electric shock. The exterior receptacle is located on the right side of the vehicle, beside the refrigerator grille).

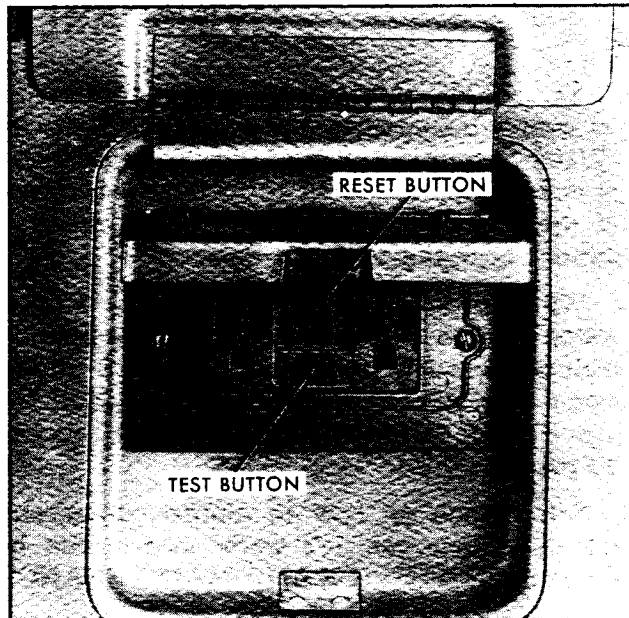

Exterior Receptacle

The exterior ground-fault circuit interrupting receptacle is designed to protect people using appliances that are plugged into this receptacle.

If an appliance continuously trips the receptacle, the appliance is defective and should be repaired or replaced.

TESTING THE EXTERIOR RECEPTACLE

For maximum protection against electrical shock hazard, the exterior receptacle should be tested at least once a month and the test date recorded.

TEST PROCEDURE:

1. Push "test" button. The "reset" button should pop up, showing a red line which indicates that power to the protected circuit is discontinued.

2. To restore power, push the "RESET" button.

CAUTION

If the "RESET" button does not pop up when the test button is pushed, a loss of ground fault protection is indicated and a potentially lethal situation exists. Do not use. Have receptacle serviced by a qualified electrician.

LIVING AREA WATER SYSTEM

Your GMC Motorhome is equipped with its own self-contained water system. Refer to "Water System Schematic." The water tank and pressure pump is located at the right rear corner of the Motorhome. The water pump switch is located near the entrance door.

Water pressure is maintained by a 12-volt water pump which is designed to automatically maintain enough pressure to ensure a steady water flow. A pressure switch is located at the water pump to maintain line pressure between 20 psi and 30 psi.

Information on how to sanitize, drain, and maintain your vehicle's water system can be found in the SERVICE AND MAINTENANCE section.

IMPORTANT: Do not attempt to increase water pressure with high pressure air. Be sure the water pump is turned "OFF" when the water tank is empty.

FILLING WATER TANK

FILLING FROM A PRESSURIZED WATER SYSTEM

NOTE: The water tank fill door is equipped with a lock. The key for this lock (oval head) is the same as for the entrance door, glove box and external utilities compartment.

1. Unlock filler door and open.
2. Unthread water fill cap from filler opening.

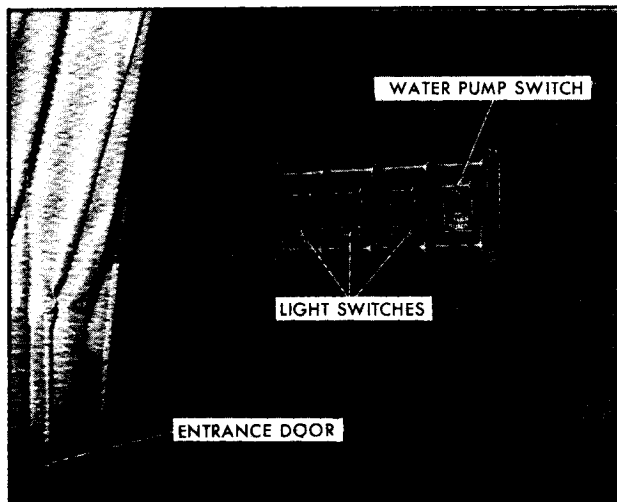

Location of Water Pump Switch

3. Insert hose or funnel into filler opening and fill tank. Capacity of water tank is 40 gallons.

NOTE: When tank is full, water will spill from the filler opening.

4. Turn on water pump switch. Open bathroom faucets to clear air from lines if the water tank has been dry and to let water heater fill.

5. Install filler cap securely after filling tank to help prevent contamination of water system.

6. Always lock water tank fill door.

EXTERNAL WATER CONNECTION

Connecting to a park or city water supply is easily accomplished. It is not necessary to drain the vehicle's water system.

1. Remove the plastic cap at the hose connection located in the external utilities compartment.

2. Attach hose and turn ON external water supply.

3. When disconnecting hose, be sure to install plastic cap at hose connection to aid in keeping dirt out of water lines.

IMPORTANT: To avoid possible damage to external water connection components, from freezing, when not being used—perform the following:

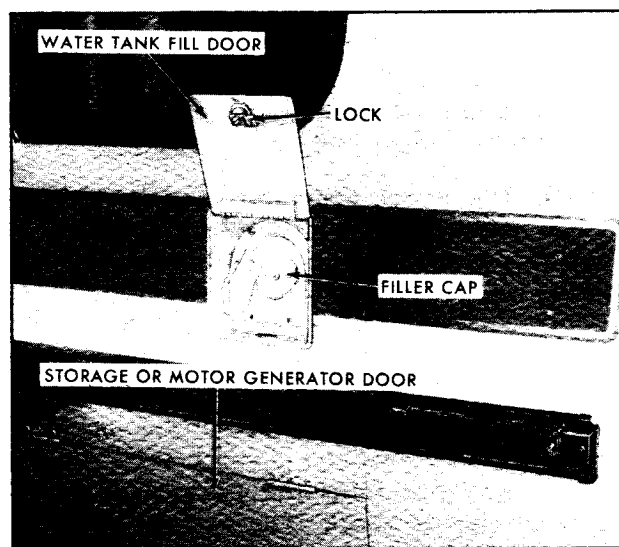

Location for Filling Water Tank

ZE06584

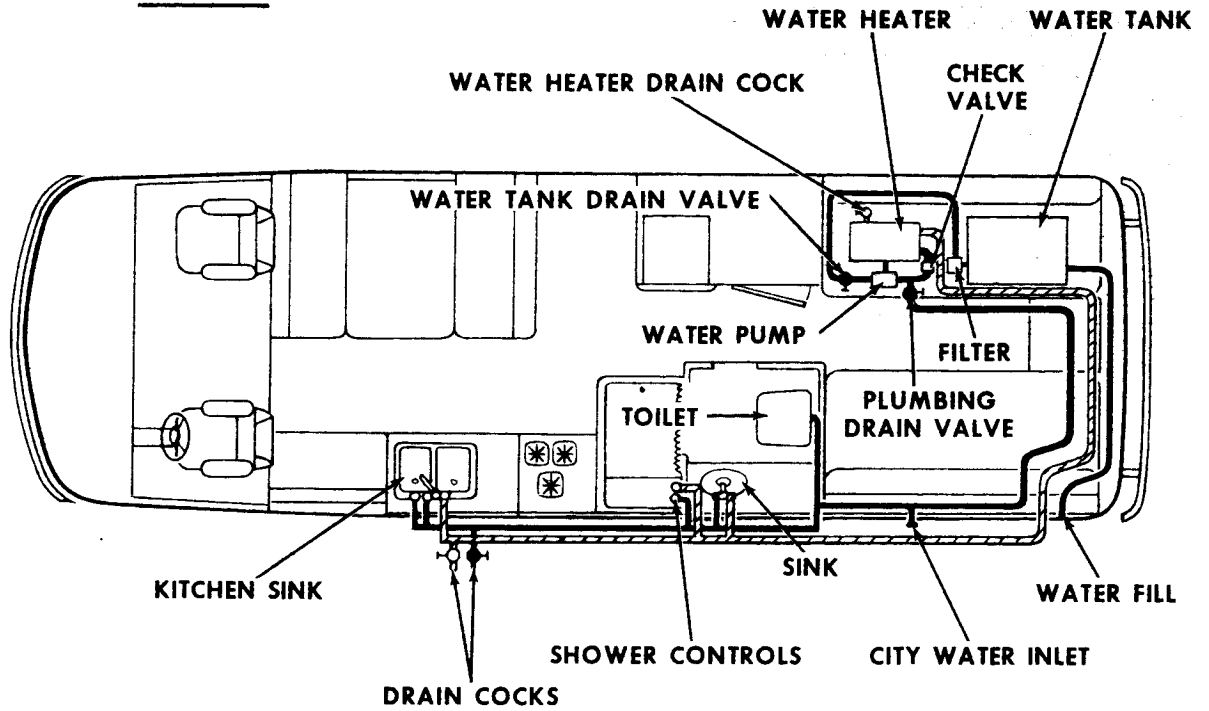

ZE06581

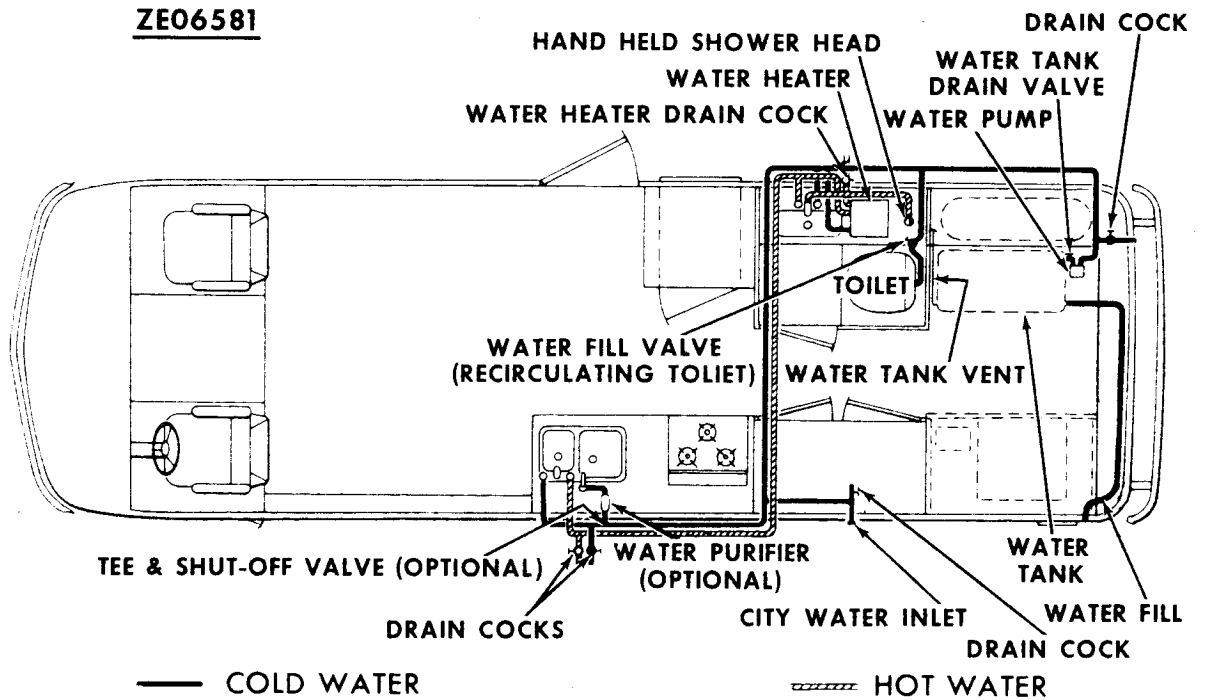

A-6038

Living Area Water System (Typical)

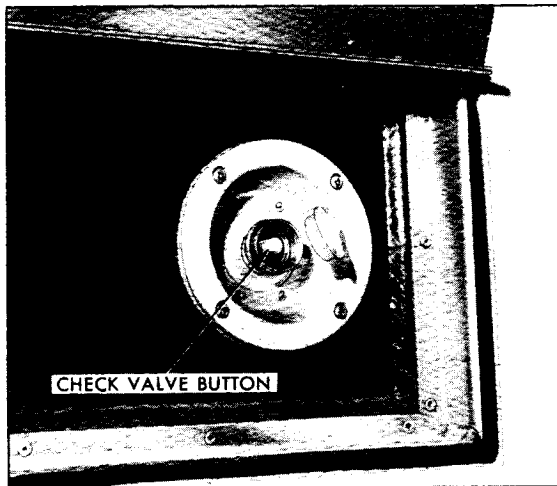

External Water Connection

- a. Remove access cover from lower shelf in closet.
- b. Open drain valve for external water connection (See Page 108).
- c. At the external water connection, momentarily depress the check valve button to allow this portion of plumbing to drain.
- d. Install hose connection cover.
- e. Close drain valve and install access cover in closet.

WATER PUMP

A 12-volt pressure water pump is used to operate the water system. The water pump operates off the vehicle's auxiliary 12-volt battery. The water pump is activated by a switch located near the entrance door. The water pump switch is amber in color and lights up when switch is in "ON" position. The pump's pressure switch is factory adjusted to hold a line of pressure from 15 psi to 30 psi. When initially starting the water pump or if the pump has not been operated for some time, open the kitchen faucet to release line pressure before turning ON switch. After pump has been started, leave faucet open until water flows and lines have been cleared of air. Once this procedure has been followed, the pump will work automatically and will maintain a line pressure from 15 psi to 30 psi.

When the water storage tank runs dry, or when the unit will be out of operation for a period of time, the water pump switch should be turned OFF.

It is a good idea to travel with the pump switch OFF unless water is needed. The pump runs quietly and may not be heard.

If the following maintenance problems should arise, follow the step-by-step procedures. If they do not solve the problem consult a GMC Motorhome dealer.

1. Pump will not prime (it should do this automatically):
 - a. Check to be sure there is water in the tank.
 - b. Check to be sure battery is not run down.
 - c. Check for kinks in the inlet hose.
 - d. Check for air leaks at inlet fittings. If air is leaking into inlet fittings, tighten fittings or apply clamps as necessary.
 - e. Check for clogged line.
2. Pressure drops:
 - a. Check faucets and connections for leaks.
 - b. Make sure faucet aerators are clean.
 - c. Check to be sure there is water in tank.
 - d. Check to be sure the battery is not run down.
3. Pump runs when there is no apparent demand for water:
 - a. Check all faucets and fixtures to make sure they are shut off and not leaking.
 - b. Check lines for leaks.
 - c. Make sure there is water in the tank.

WATER HEATER

Your GMC Motorhome is equipped with a 6-gallon 120 volt AC water heater with a factory setting of 150°F. It is located on model ZEO 6581 behind the lower storage compartment in the bathroom. On Model ZEO 6584 the water heater is located in the rear, right-hand corner of the vehicle, beneath the right-hand bed.

The water heater, in either model, has a drain valve to be used when draining the water system. An "ON-OFF" switch for the water heater in Model ZEO 6581 is located in the living area electrical compartment, in Model ZEO 6584 it is located in the bathroom, on the wall, behind and to the left of, the sink.

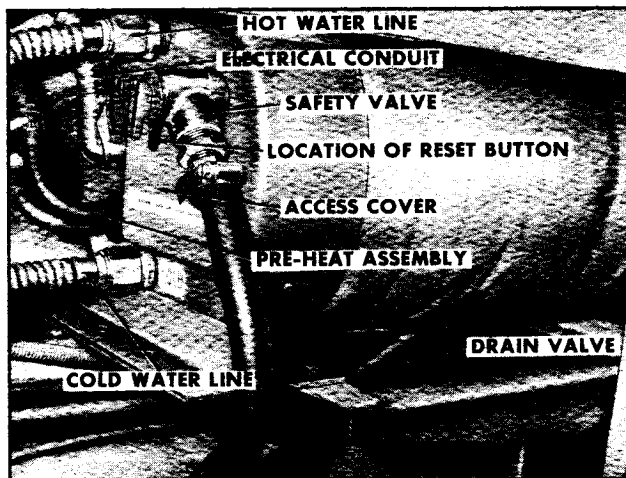

Water Heater (Typical)

If hot water is not being supplied, check to be sure that water heater switch is turned "ON". If hot water is still not supplied, depress reset button located behind access cover at point shown on water heater illustration.

CAUTION

Do not operate water heater unless there is water in the living area water system. If unit is operated without water this will result in damage to the heating element.

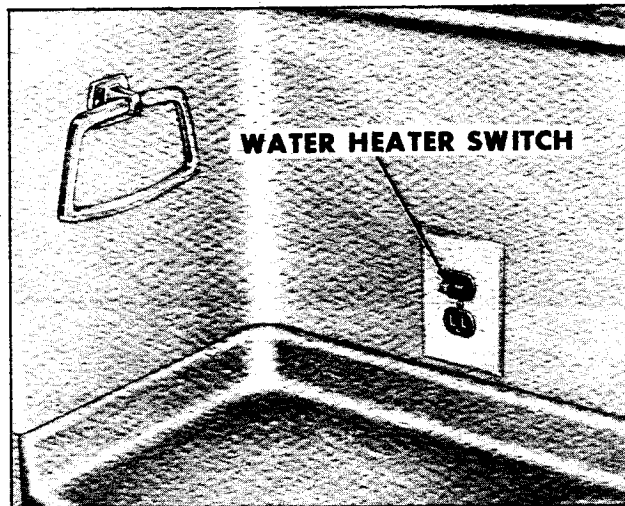

Water Heater Switch (ZEO 6584)

The Motorhome water heater, if equipped with a pre-heat, pre-heats the water in the water heater by circulating engine coolant through hoses to the water heater and back to the engine. The pre-heater will heat water only if the engine is running and at normal operating temperature. Otherwise, the water heater operates on 120-volt AC power from the motor-generator (if equipped) or from an external 120-volt AC source (see "External Power" previously in this section for additional information).

KITCHEN FACILITIES

ALL-ELECTRIC REFRIGERATOR

The Norcold All-Electric Refrigerator will operate either on 12-volts DC or 120-volts AC. It operates on the same principle as the standard domestic refrigerator. This dual-voltage refrigerator automatically switches from AC to DC or DC to AC. When a power supply of 120-volts AC is connected to the vehicle, the voltage selection relay is energized and disconnects the unit from DC operation. When the AC supply is disconnected, the refrigerator automatically reverts to DC operation.

Turning the thermostat knob to the "OFF" position will stop operation of the refrigerator.

NOTE: A key is provided to lock the refrigerator door(s) if equipped with a lock. This is an aid to keep door(s) closed while vehicle is moving.

OPERATION

A single thermostat controls the operation of the refrigerator. This thermostat is mounted at the rear, inside the refrigeration cabinet below the freezer compartment. The knob is marked

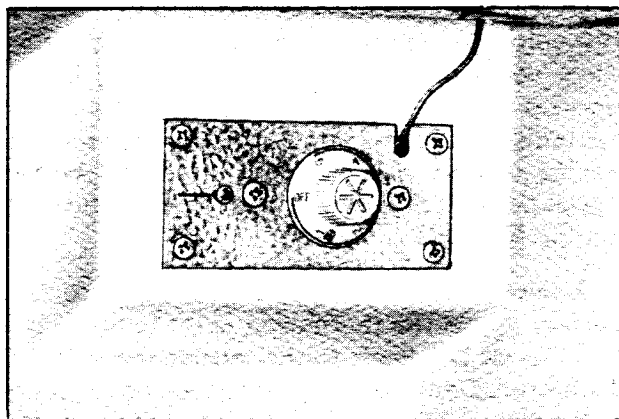

All Electric Refrigerator (Control Panel)

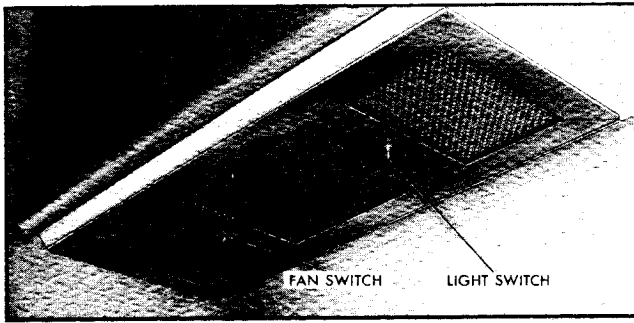

Power Range Hood

“OFF, 1, 2, 3, 4, 5.” The nearer the knob is set to “5,” the colder the temperature becomes in the cabinet.

Once the desired temperature is reached, the thermostat will control the cabinet temperature equally well on either voltage supply.

There is a circuit breaker incorporated in the 12-volt circuit of the refrigerator. It is located behind the kick plate below the refrigerator door. When the circuit breaker opens a small light will come on beside the breaker. The circuit breaker is reset by pushing IN on the red button next to the light.

OPERATING TIPS

The following operating suggestions will serve as a guide in operating your unit efficiently during 12-volt DC (battery) operation:

1. In order to conserve battery power it is advisable to set the thermostat knob at the lowest setting that will provide adequate refrigeration. This practice will reduce the running time of the refrigerator and draw less current from the battery. A setting of “3” is a normal position.

2. Always operate the refrigerator with a 120-volts AC source connected to the Motor-home when available, especially during initial start-up of the unit. Depending upon the ambient temperature, the initial start-up may require one to two hours continuous operation before refrigeration temperatures are attained and unit cycling begins.

3. Never employ “Quick Chargers” to the battery unless the thermostat is set to “OFF” or the 12-volt DC leads to the refrigerator are disconnected. Damage will occur if the high voltage of the “Quick Charger” is permitted to reach the DC circuitry of the refrigerator.

Leveling

The All-Electric Refrigerator will operate efficiently 30 degrees off-level so it is not necessary to level the refrigerator.

Defrosting

Since ice and frost are poor heat conductors, a frost build-up of $\frac{1}{4}$ ” or more should be avoided. It decreases overall cooling capacity and increases power consumption. To lessen frost accumulation avoid putting hot or steaming food in the refrigerator.

To defrost the refrigerator, turn the thermostat to the “OFF” position. When accumulated ice has melted, the water can be removed from the drip pan under the freezer compartment.

Cleaning

The cabinet interior should be cleaned regularly. Remove shelves and wash the lining with lukewarm water to which a mild soap may be added. Dry thoroughly, especially around door frame and door gasket. Warm water only should be used to wash the cooling evaporator, ice trays and shelves. Never use strong chemicals or abrasive cleaning materials on any part of the cabinet.

To Shut Off Refrigerator

When refrigerator is not in use set the thermostat to “OFF,” remove water from drip pan, remove all food-stuffs from cabinet, and leave door slightly ajar to permit air circulation.

KITCHEN RANGE/OVEN

IMPORTANT: Before operating the Range/Oven see the carbon monoxide caution at the beginning of this section.

Always wait 5 minutes before relighting Range/Oven to allow excess gas to dissipate.

Recreational vehicle range/ovens differ from conventional residential units in several ways:

1. The units are more compact.
2. The units are equipped with oven thermostat control which allow you to manually shut off the gas to the oven pilot when traveling. Also, the range pilot is controlled by a separate range pilot shut off valve.

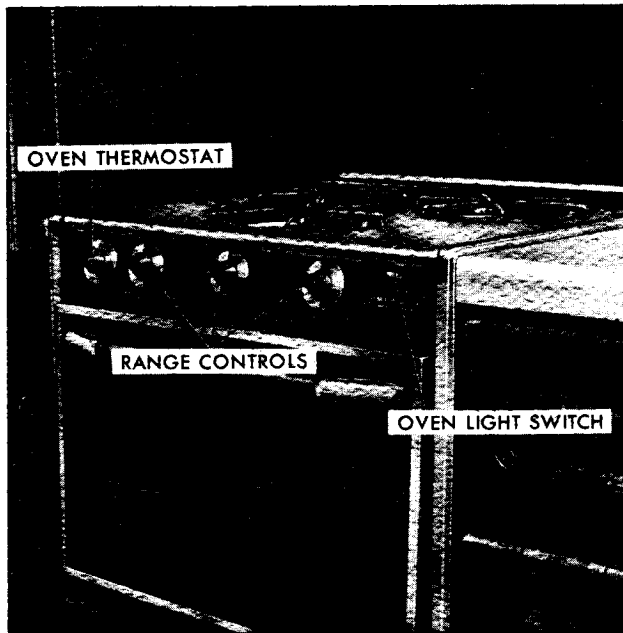

Range/Oven Controls (Typical)

3. Clips are provided for the top burner grates and oven rack to help prevent rattles and dislodgement while traveling.

Any time the range/oven is in operation, the power range hood fan should be operating to help ensure proper ventilation.

In order to operate the range/oven the gas supply must be turned on at the L.P. gas tank.

CAUTION

The Range/Oven should not be used when the vehicle is moving, and the LP gas should be turned off at the LP gas tank. The burners or pilot lights may blow out creating a fire or explosion hazard. In addition, a sudden movement of the vehicle could throw utensils or scalding liquids from the stove which could result in serious personal injury or property damage.

OPERATION OF 3-BURNER UNIT

The 3-burner range/oven has two pilots—one for the 3 range burners and one for the oven.

Pilots

1. Turn on power range hood fan.
2. Be sure manual control valve at LP gas tank is fully open (see page 94 for location of valve).

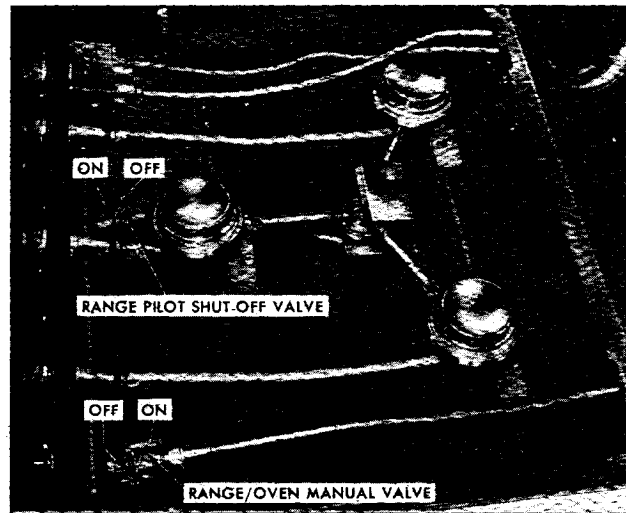

Range/Oven LP Gas Valves



Lighting Range Pilot

3. Be sure all knobs are in the "OFF" position. The oven thermostat should be in the "PILOT OFF" position.

4. Lift cook top panel and turn range/oven manual valve and range pilot shut off valve to ON position.

5. Light range pilot with a match as shown.

6. Depress the oven thermostat and turn counterclockwise to OFF position.

7. Open the oven door, allow the compartment to ventilate, then light the oven pilot with a match. A small flame should be noted at the top of the pilot burner. After the initial light-up, it may take a minute or so to clear the air from the line so the flame stays lit.

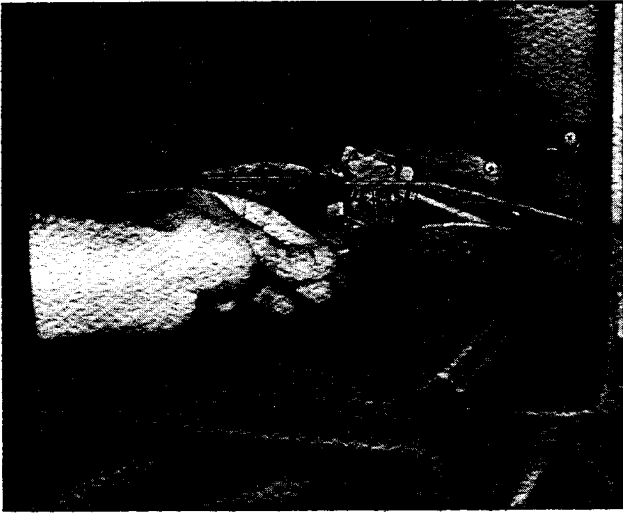

Lighting Oven Pilot

CAUTION

When lighting pilots, it is recommended BOTH pilots be lit, even if plans are to use just one cooking means. Once the oven thermostat is moved from the "PILOT OFF" position and the range pilot shut off valve is in the ON position, gas will issue from both range and oven pilots. Failure to light both pilots could result in fire or explosion caused by accumulating LP gas.

8. The oven pilot is non-adjustable. The range pilot adjustment screw is located behind the range pilot shut off valve.

RANGE

1. Be sure power range hood fan is operating.
2. Push control knob in and turn gas on counterclockwise all the way to get gas to the burner.
3. As soon as the burner lights, flame may be reduced to the desired height.
4. To turn off the burner, turn the control knob clockwise all the way to the "OFF" position. The knob is designed to lock in this position.

OVEN

1. Be sure power range hood is operating.
2. To turn on the oven light, push in oven light button located at the right side of the knob panel. Push again to turn out.

3. To light the oven burner, depress and turn the thermostat dial counterclockwise to the desired temperature setting. It will take approximately 45 seconds before the safety valve will open and the oven burner ignites.

4. When through with oven, turn the thermostat dial to the "OFF" position. In this position the oven pilot will remain lit.

5. When traveling or when the Motorhome is not in operation; return the thermostat dial to the "PILOT OFF" position and turn range/oven manual valve and range pilot shut off valve to OFF position. This should turn off the gas to the range and oven pilots.

CARE AND CLEANING

- **POWER RANGE HOOD FILTER**—It is important that the power range hood filter be inspected frequently and cleaned as needed. To clean filter, remove retaining nuts at power hood switches, remove filter and wash in hot, soapy water. Rinse thoroughly and reinstall.
- **GENERAL**—Regular cleaning with a warm detergent solution and a soft cloth will keep your range looking bright and new. This should be done as soon as range cools.
- **CHROME**—To keep the mirror bright finish, wipe with a damp cloth and dry thoroughly. Stubborn stains may be removed with lemon juice, vinegar, or chrome polish.

NOTE: Properly clip the top burner grates and oven rack after cleaning to help prevent them from rattling or becoming dislodged while the vehicle is underway.

- **GLASS**—Wipe cooled glass with detergent and hot water. Rinse and polish with a soft cloth.
- **BROILER PAN**—Remove the broiler pan from oven immediately after use. Drain fat. Sprinkle rack with detergent and cover with wet paper towels and let soak before washing in hot soapy water.
- **OVEN INTERIOR**—Clean as soon as possible after use when the oven is cool. Grease spatters that are allowed to become hard and baked on become very difficult to remove. Care must be taken to avoid bending the thermal sensing element, which could cause a variation between the oven tempera-

ture and the dial setting. If oven cleaners are used, protect aluminum gas tubing, thermostat sensing element and electrical components from the cleaners. Thoroughly rinse oven with a solution of one tablespoon vinegar to one cup of water and wipe dry.

- **TOP BURNERS**—Top burners may be cleaned with a detergent solution. If any burner port should become clogged, clean with a toothpick. Never use pins or other metal objects to clean the ports, as they may become enlarged. If the burner is washed in a sink, dry immediately by shaking off all excess water and lighting the burner until all water has evaporated.

OPERATING TIPS

- The Range/Oven is not designed for and should never be used as a space heater. Do not leave the oven door open while the oven is on.
- Do not operate range/oven while traveling or while refueling your vehicle at a gasoline service station. The pilot lights or burners may ignite gasoline fumes.
- Do not leave the top burners on without a utensil for any length of time. Overheating of the grates may cause the porcelain enamel to craze and chip.
- Your range has an oven light bulb, do not clean it while hot. After it has cooled, wipe it clean with a damp cloth.
- Do not use broiler area to store utensils as the oven burner and pilot may become damaged, or knocked out of proper alignment.

KITCHEN SINK AND FAUCET

Your GMC Motorhome is equipped with a stainless steel double bowl sink with a swing spout and adjustable spray spout. To operate faucet pull the handle up, turn clockwise for cold water and counter-clockwise for hot water. For cleaning and care of the stainless steel sink see the APPEARANCE CARE section later in this manual for more information.

WATER PURIFIER

An optional water purifier is located at the kitchen sink. The purifier cartridge assembly is located in the cabinet below the kitchen sink.



Kitchen Sink and Faucets

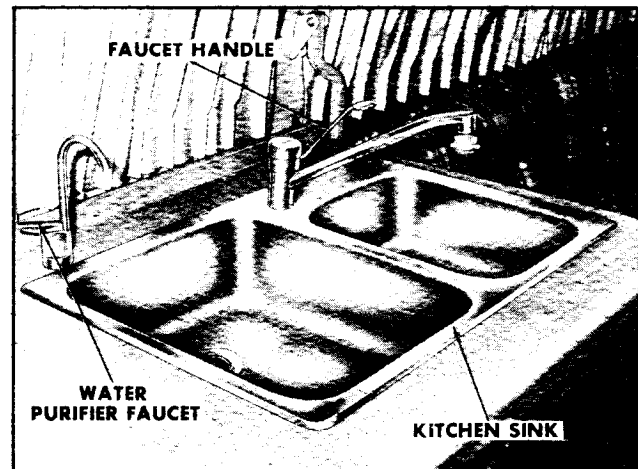

Water Purifier Faucet

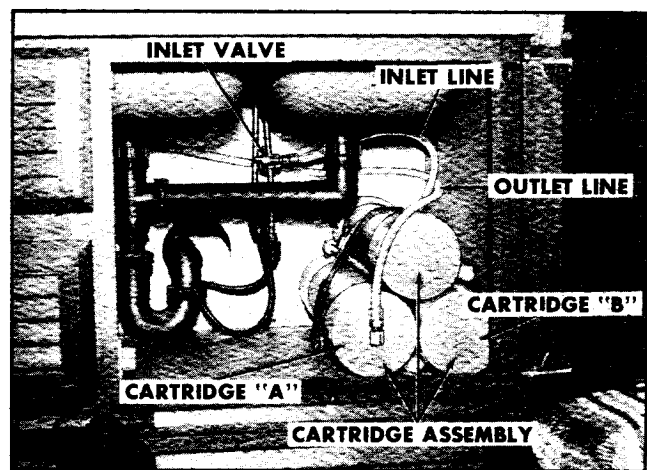

Water Purifier Cartridge Location (Typical)

When unit is new or after cartridge assembly replacement, open the water purifier faucet. Allow the water to run for about five minutes. A slight grey color in the water is designed to disappear after several minutes.

NOTE: Under normal family usage the purifier cartridge assembly is designed to last for several years. Interval for replacement of either cartridge may be determined by restriction of water flow at purifier faucet. The filter cartridges are designed to restrict water flow when replacement is required. Be sure the purifier cartridge assembly (all three tanks) is removed from the vehicle when unheated, and temperatures fall below freezing. The cartridge assembly should then be stored in a heated facility.

PURIFIER CARTRIDGE REPLACEMENT

NOTE: Replace the primary cartridge "A" (refer to sticker on cartridge for identification) when the flow rate diminishes. Cartridge "B" may also require replacement after an extended period of use. This replacement is to be made when the replacement of cartridge "A" fails to restore the flow rate of assembly to a satisfactory level.

1. Shut off water pump and close inlet valve to purifier cartridge assembly.
2. Remove plastic tubing connectors at either end of old cartridge.
3. Remove old cartridge and discard.
4. Locate the new replacement cartridge in the same position as the one just removed with arrow on label pointing to the outlet end of unit.
5. Connect plastic tubing to the new cartridge making certain that the tubing coming from the inlet valve connects to the "INLET" fitting.
6. Open the inlet valve, turn on water pump and then place purifier faucet handle in the "UP" position (purifier faucet is located beside the kitchen sink faucet). Allow a full flow of water from faucet for about 15 minutes. Purifier is now ready for normal usage.

BATHROOM FACILITIES

STANDARD TOILET

The standard toilet is a fresh water sanitation system. It uses a pressure flushing system

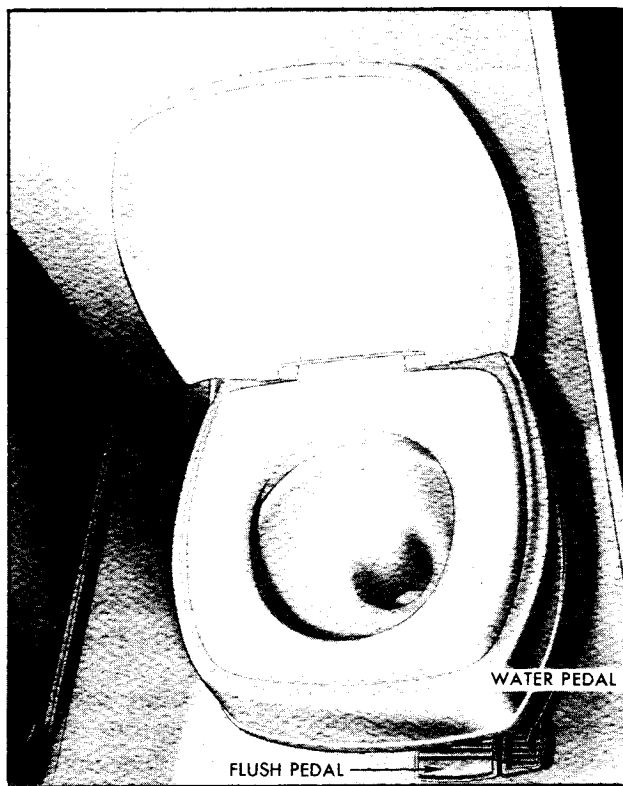

Standard Toilet

wherein water cleans the bowl with each flush and washes contents directly into the holding tank. This water injection produces a swirl effect and uses a measured amount of water to rinse efficiently. The unit is a self-cleaning type designed with an odor and gas tight teflon seal which closes off the holding tank when not in use. Since every flush uses fresh water, chemical additives are not mandatory.

OPERATING INSTRUCTIONS.

1. After use, depress flush pedal located at base of toilet. This will automatically flush and refill toilet with water. Keep pedal depressed until bowl is cleansed and release.
2. If you wish to add water to bowl without flushing, depress the water pedal. Hold depressed until desired water level is reached and release.
3. Cleaning of toilet bowl can be accomplished by using any high grade, non-abrasive cleaner. Highly concentrated or high acid content cleansers might damage rubber seals.
4. The toilet dumps directly into the vehicle holding tank. Therefore it is recommended that holding tank be drained at regular intervals to avoid overfilling. The suggested drain interval is, whenever refilling living area water tank.

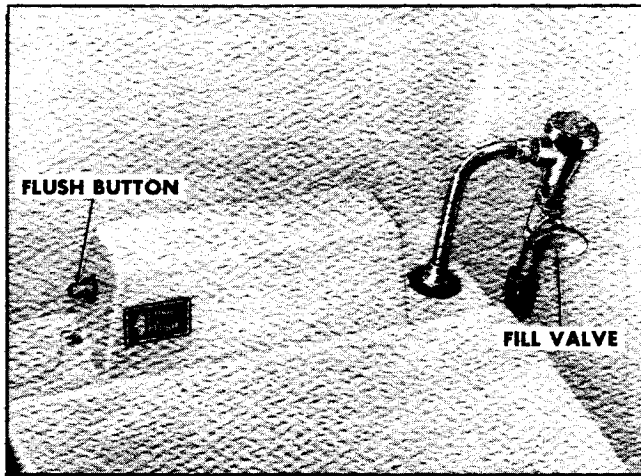

Recirculating Toilet Controls

OPERATING TIPS FOR TOILETS

1. Do not put facial tissue, automotive type anti-freeze, coffee grounds, laundry bleach, or highly concentrated or high acid content household cleaners in your holding tank or toilet systems as they may damage the plastic or rubber parts in the system.

2. Special non-toxic non-flammable deodorizing chemicals can be added to holding tank, but are not required. Follow directions on container.

3. Be sure to use biodegradable toilet tissue *ONLY* in the GMC Motorhome to maintain holding tank sending unit operating performance.

4. Keep your holding tank drain valve closed when parked and connected to a sewer system. By doing this, enough fluids are put into the holding tank to entirely wash away the waste in the holding tank when drain valve is opened.

5. Details on winterizing or draining vehicle holding tank are covered in the **SERVICE AND MAINTENANCE** section of this manual.

RECIRCULATING TOILET

The optional recirculating toilet operates by recirculating a chemical solution. The advantage is that you are conserving water when flushing and also by not adding volume to your holding tank. The toilet operates on 12-volt DC.

OPERATING PROCEDURES

Initial Flush Charge

1. Be sure handle on dump valve is pushed in.

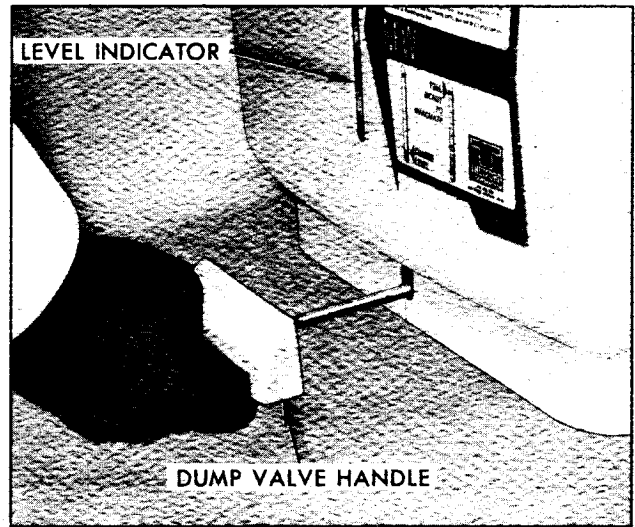

Dumping Waste Contents of Recirculating Toilet

2. Open fill valve, filling toilet to the charge level as indicated by the letter "C" on prism. This will be approximately 3 gallons. Close the fill valve.

3. Add recirculating toilet chemical as recommended by manufacturer of chemical.

To Flush

Depress flush button and hold for approximately seven seconds.

NOTE: Do not depress flush button when unit is empty.

To Empty Toilet Into Holding Tank

1. When prism indicator shows level at the letter "F" it is time to empty the toilet. When full, toilet holds approximately seven gallons. The toilet may also be emptied when the blue chemical solution turns green as this is an indicator that the active ingredients are used up.

2. Pull the dump handle all the way out. The handle is located near the floor at the center of the front of the toilet. When toilet is empty, as indicated by the prism, push the handle back in and recharge toilet as directed under "Initial Flush Charge" described previously.

CLEANING TIPS

1. There are several excellent cleaning compounds that may be used. Be sure to read the

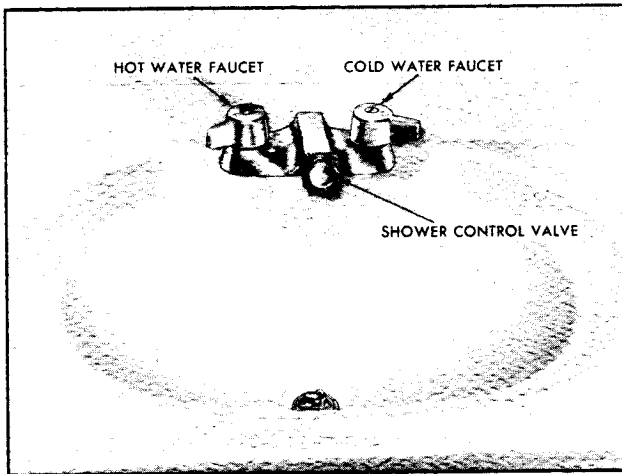

Bathroom Sink (ZEO 6581)

label to be sure compounds will not damage plastic parts and tubing.

2. Recreational users advise it is best to flush the toilet before each use to aid in maintaining cleanliness.

3. Another aid to flushing is to lay some toilet tissue in the bowl just prior to use.

BATHROOM SINK AND SHOWER CONTROL VALVE (ZEO 6581)

The Motorhome Model ZEO 6581 bathroom sink has the shower control valve built into the spout.

With the shower control valve knob pushed in, the off position, water temperature may be

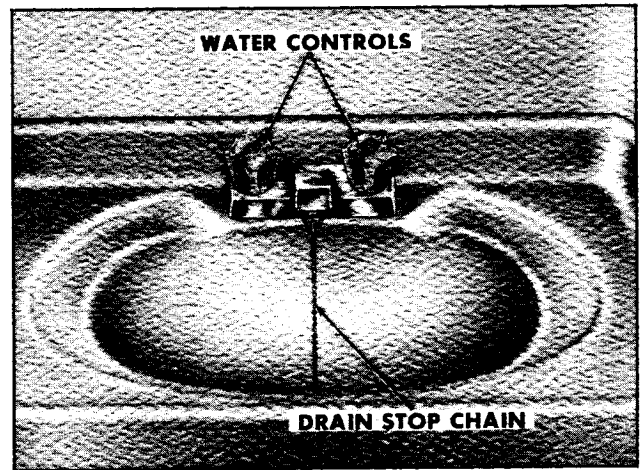

Bathroom Sink (ZEO 6584)

adjusted prior to taking a shower. Once the desired temperature is set, remove the shower head from the wall and point towards the sink. Open the valve at the shower head, pull the shower control valve knob out and allow water to flow into sink until it warms to the desired temperature. Adjustments in temperature may be made as required.

Showers can take a lot or a little water. A suggestion would be to take a "camper's" shower. Wet yourself down, then turn off the water at the shower head, soap up and then turn water back on to rinse.

NOTE: Remove shower drain plug before taking a shower. Shower drain plug should be installed when shower is not in use.

NOTE: Leave shower head valve in off position when not in use to avoid getting showered unexpectedly when the shower control valve is turned on.

BATHROOM SINK AND SHOWER CONTROL VALVE (ZEO 6584)

The Motorhome Model ZEO 6584 has separate bathroom sink and shower control. The bathroom sink has hot and cold water controls that deliver through a single spout. The water temperature can be adjusted by changing the relative amount of hot or cold water.

The shower control is located in the separate shower area. There are hot and cold water controls located on the wall inside the shower. The

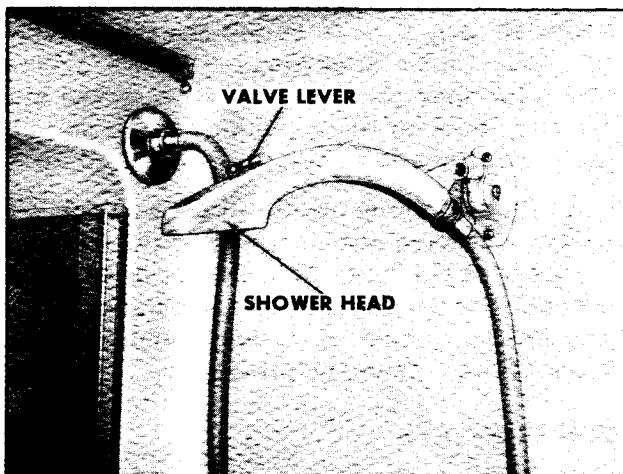

Shower Head (Typical)

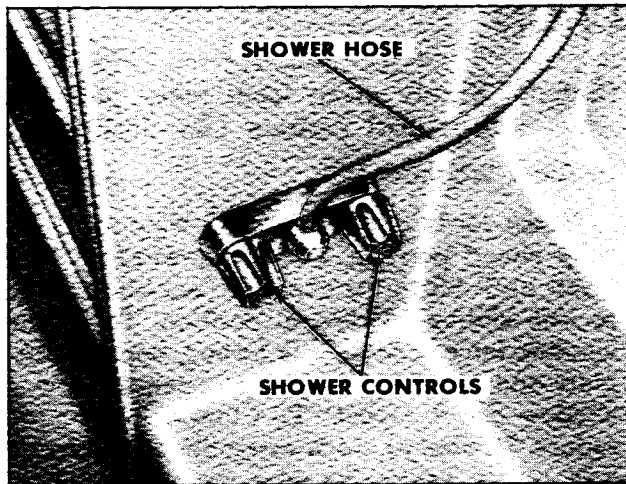

Shower Controls (ZEO 6584)

shower water temperature can be adjusted by changing the relative amount of hot or cold water. To adjust, take the shower head off of the wall mount and hold it near the shower drain while setting the water temperature. Then put the shower head in the "off" position and replace it on the wall mount. When ready for use turn the shower head valve over to the "on" position.

BATHROOM WARM AIR DUCT

The warm air duct is non-adjustable. In the ZEO 6581 model it is located near the bottom of the shower compartment, and in the ZEO 6584 model is located on the lower wall to the left of the sink. Warm air will be supplied when furnace is operating.

BATHROOM EXHAUST FAN

Located in the ceiling of the bathroom is the bathroom exhaust fan. Push upward to open and pull downward to close. Power vent button switch is located at corner of vent.

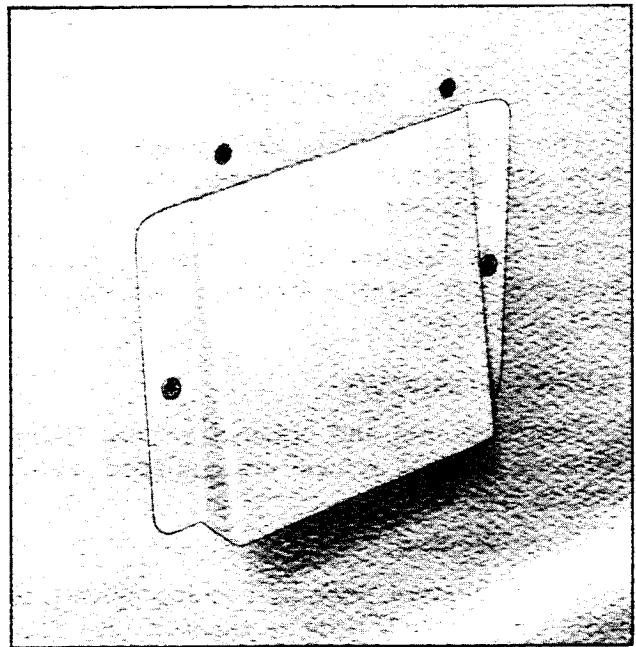

Bathroom Warm Air Duct (Typical)

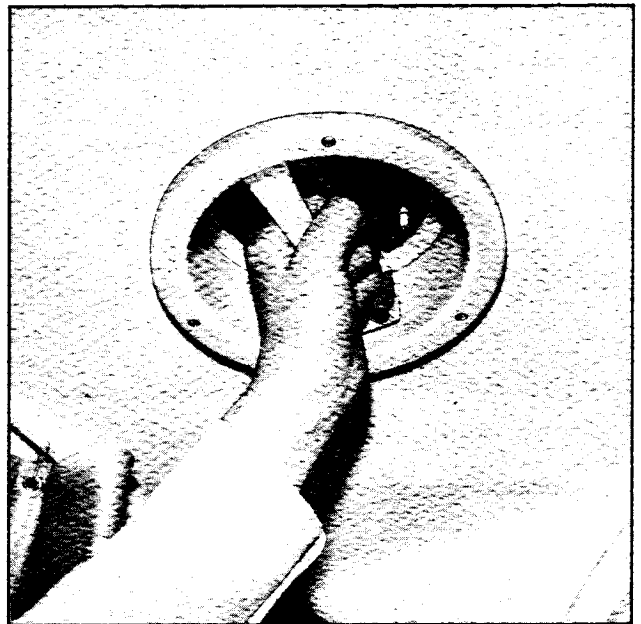

Bathroom Exhaust Fan

VENTILATION

WINDOWS

The side windows in the driver's compartment are operated by squeezing the latch and sliding the window to the rear.

The side windows in the living area are equipped with screens. The windows are operated as follows:

SLIDING WINDOWS

The horizontal and optional vertical sliding windows in your vehicle are equipped with a locking type latch.

To Open Window

Unlock window latch by pushing upward on button, until latch lever is exposed (see illustration).

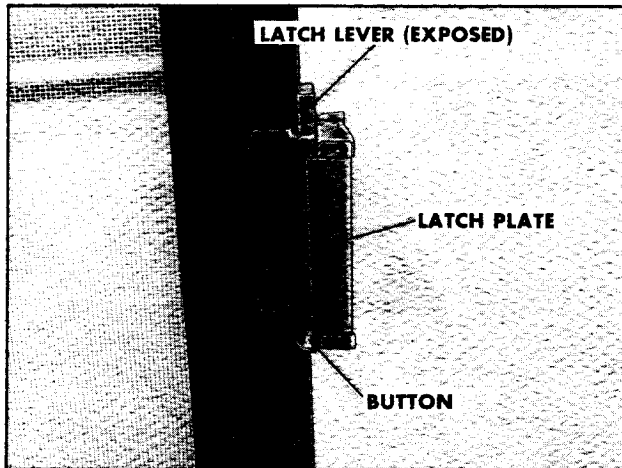

Window Latch (Unlocked)

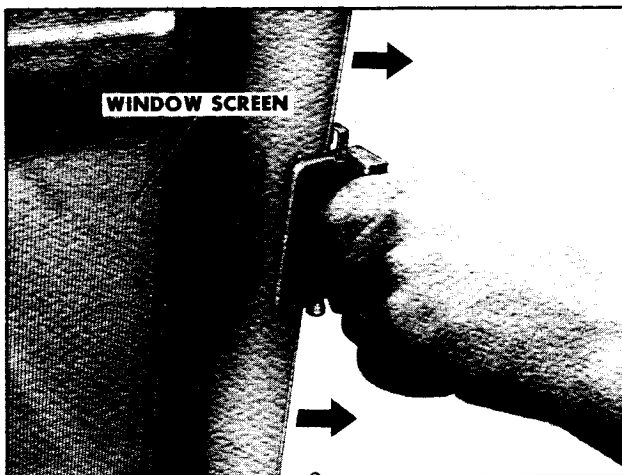

Opening Horizontal Window

tration). Firmly grasp latch plate, and slide window to desired position (see illustration).

To Close Window

Grasp latch plate, and slide window to the fully closed position. Push downward on latch lever, until button is exposed (see illustration) to lock sliding window in position. To be sure window latch assembly is locked, depress latch plate and carefully attempt to open window. If window opens, repeat "To Close Window" procedure. If window latch assembly still does not lock return vehicle to your dealer for service.

NOTE: If windows do not slide easily in sliding glass track, it may be helpful to spray track grooves with Silicone Spray Lubricant, GM Part No. 150018 or equivalent.

CEILING VENTS

The purpose of the ceiling vents is to allow warm air to escape that may accumulate at ceiling level when the vehicle is parked in the

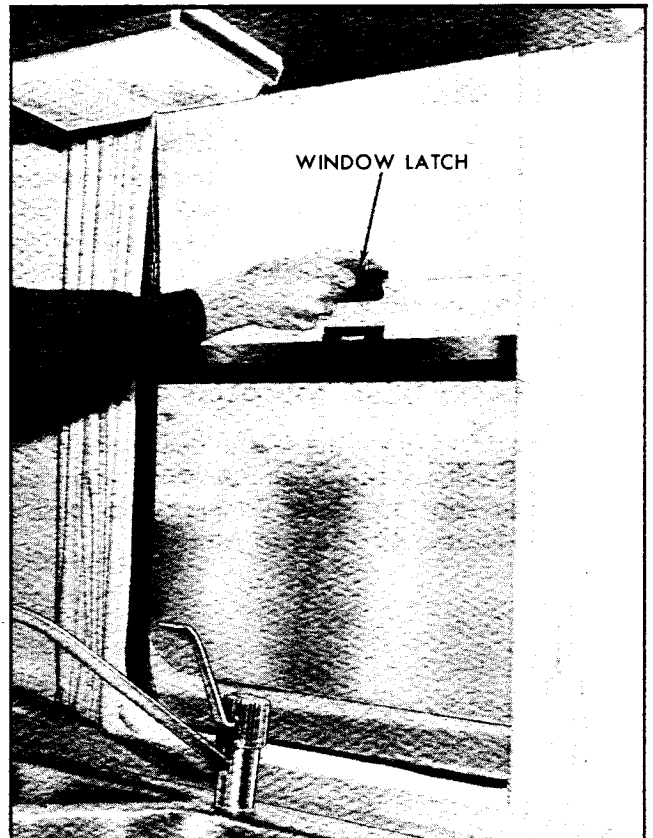

Opening Vertical Sliding Window

sun. The opening of a ceiling vent and a window will aid in removing condensation from the windows.

The vents are crank-operated from inside the Motorhome. In rainy weather it is possible to leave the ceiling vents open slightly for ventilation without entry of water into the Motorhome (depending upon the magnitude and direction of rain).

NOTE: All windows and roof vents must be tightly closed when operating the air conditioner or furnace to obtain maximum cooling or heating.

Power fans are available for the ceiling vents. These will increase the efficiency of the vent. They are operated by the button switch at the corner of the vent.

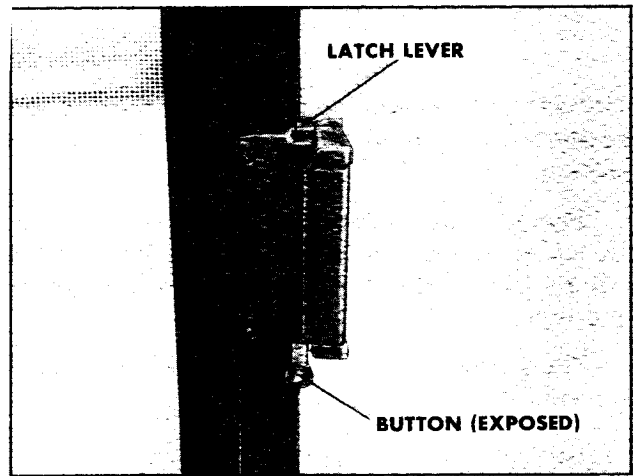

Window Latch (Locked)

ROOF MOUNTED AIR CONDITIONER

The controls of the air conditioner are mounted on the unit in the ceiling of your Motorhome and can provide either cooling or air circulation.

To operate the unit for air circulation, set the blower fan switch at the desired setting:

Hi Fan High Fan Speed Only

Med. Fan Medium Fan Speed Only

Low (Lo) Fan Low Fan Speed Only

To operate the unit for cooling set the thermostat and the blower fan switch at the desired settings:

Hi Cool High Fan Speed with Cooling

Med. Cool Medium Fan Speed with Cooling

Low (Lo) Cool Low Fan Speed with Cooling

Air distribution to the vents on the Duo-Therm unit is controlled by the air distribution knob. Louvers on each vent can be adjusted to the desired position.

The unit is shut down by placing the blower switch in the "OFF" position. The Duo-Therm unit is equipped with a delayed start feature. When the unit is turned on, the fan will start,

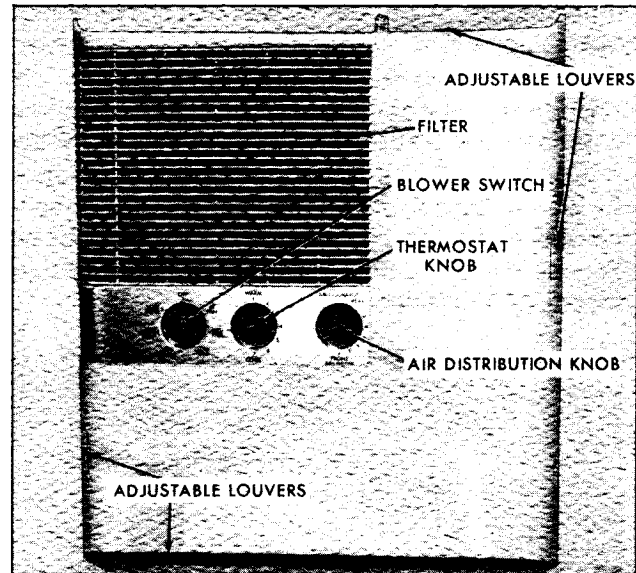

Duo-Therm Air Conditioner Controls

and in approximately two minutes the compressor will start. After shut down, unit will not start for approximately two minutes.

The air filter must be checked and cleaned frequently as required by use. Wash filter in warm soapy water, rinse, shake off excess water and allow to dry. (Do not use compressed air to dry filter.)

FURNACE

IMPORTANT: Before operating the furnace see carbon monoxide caution at the beginning of this section.

The furnace in Model ZEO 6581 is located in the compartment under the kitchen sink. In Model ZEO 6584, the furnace is located below the oven.

The furnace's electrical system is operated on 12-volt DC only.

SEQUENCE OF OPERATION

Whenever operating the furnace the window above it should be fully closed, to help avoid drawing carbon monoxide exhausted from its vent back through the window.

When the thermostat is adjusted to the desired setting, furnace blower motor is energized immediately. When the blower reaches minimum operating speed (approximately 2-3 seconds) the main burner of the furnace will ignite. The furnace will continue to run until the thermostat is satisfied or is turned to a lower setting. When thermostat setting has been satisfied main burner flame will go out but the blower will continue to run for a short period of time and then shut off. When vehicle has cooled, thermostat will re-light furnace automatically.

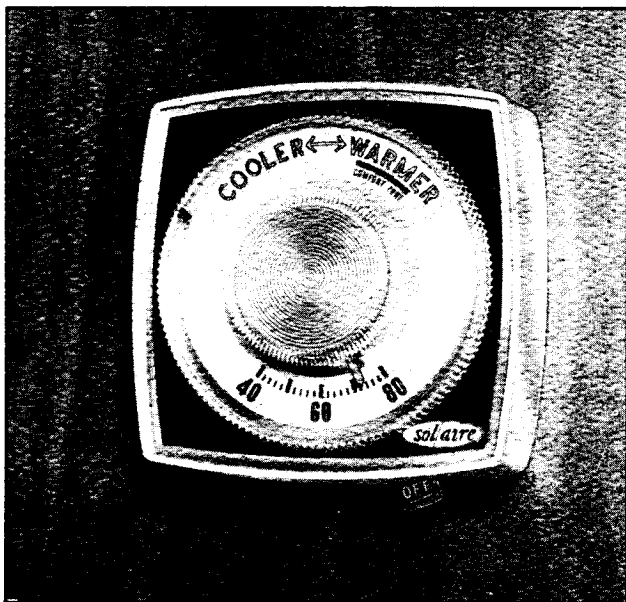

Furnace Thermostat (Typical)

REMINDER: The furnace should not be used when the vehicle is underway, and the LP gas should be turned off at the LP gas tank.

OPERATING FURNACE

This furnace has no pilot light, but is ignited by an integral, solid state, direct-spark ignition system. No manual lighting is required.

1. Set thermostat, located in rear of Motor home living area to "OFF" position.

NOTE: Be sure manual control valve at LP gas tank is fully open (see page 94 for location of valve).

2. Open furnace manual valve fully, located under sink at right side of furnace. Do not attempt to operate furnace with valve partly opened as proper operation depends on valve being fully open.

3. Set thermostat to desired setting, furnace will energize and continue to run until thermostat is satisfied or is turned to a lower setting.

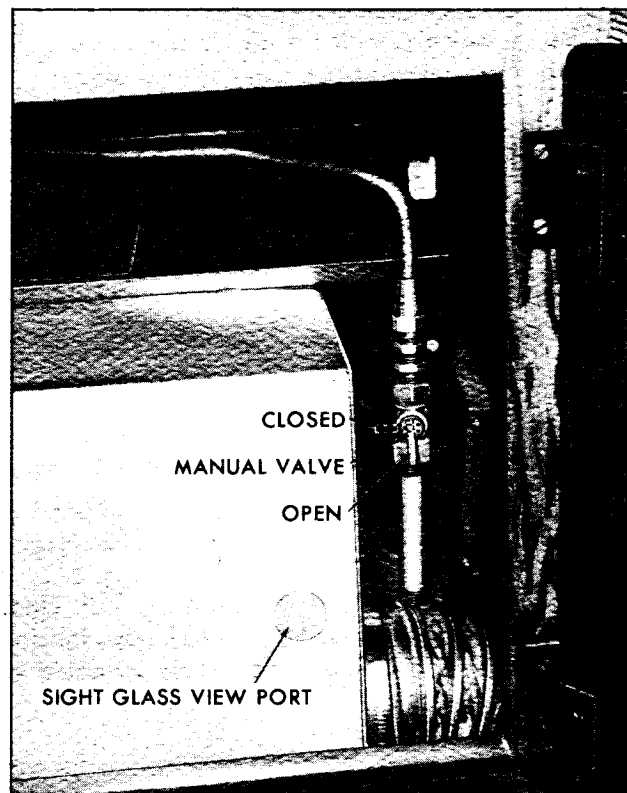

Furnace Manual Valve and View Port

NOTE: Refer to "FURNACE OPERATING TIPS" if furnace fails to ignite.

SHUTTING OFF FURNACE

- To shut off furnace set thermostat to "OFF" position and close manual valve.
- Always perform these steps as a precaution when the furnace will not be in use.

FURNACE OPERATING TIPS

If furnace fails to ignite it may be necessary to push the manual reset button, which is located next to the fuse receptacle at the front of the furnace—

1. Turn thermostat to lowest setting.
2. Open LP gas tank valve.
3. Open main furnace valve.
4. Press manual reset button on furnace.
5. Turn thermostat to a temperature above room temperature. Furnace should start.

NOTE: A rumbling or growling noise is not normal. Refer to "PRIMARY AIR ADJUSTMENT" if this occurs.

6. Set thermostat to desired temperature and it will cycle the furnace on and off as the temperature inside the Motorhome satisfies the thermostat.

If furnace is noisy, rumbling burner or smoke or carbon at exhaust vent—

1. Faulty or broken electrode.
2. Improper primary air adjustment.

If thermostat calls for heat and furnace blower does not start—

1. Depress manual reset button.
2. Blown fuse. Check fuse in furnace and also fuse located in living area electrical compartment.

3. Dead auxiliary (living area) battery or loose wiring.

Blower runs for 30-60 seconds, then stops and requires manual reset before it will restart. Burner does not ignite—

1. LP gas tank low or empty.
2. LP gas tank valve or furnace manual valve closed.
3. Low voltage at furnace.
4. Loose electrical connection at electrode.
5. Faulty or broken electrode.

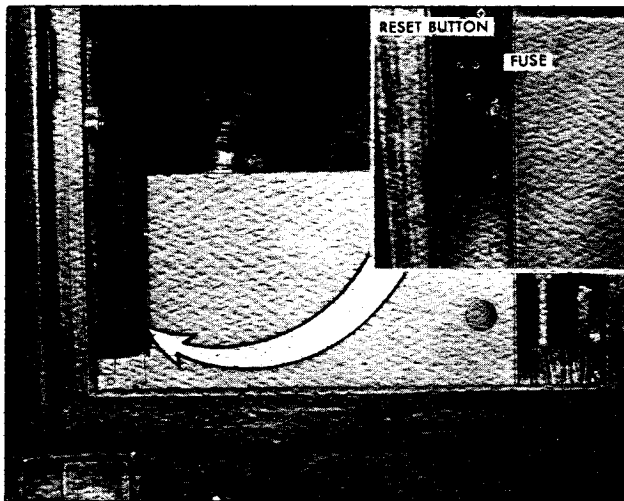

Location of Furnace Reset Button and Fuse

Blower runs 30-60 seconds, then stops and requires manual reset before it will restart. Burner does ignite—

1. Low fuel pressure.
2. Faulty flame switch.
3. Insufficient primary air.

NOTE: Before pressing the reset button to reset the control circuit, a wait of 5 minutes is required, after the furnace has stopped, before the thermal relay will properly reset.

PRIMARY AIR ADJUSTMENT

Access to the burner assembly to adjust primary air is located at the bottom, right side of the furnace compartment by removing access cover.

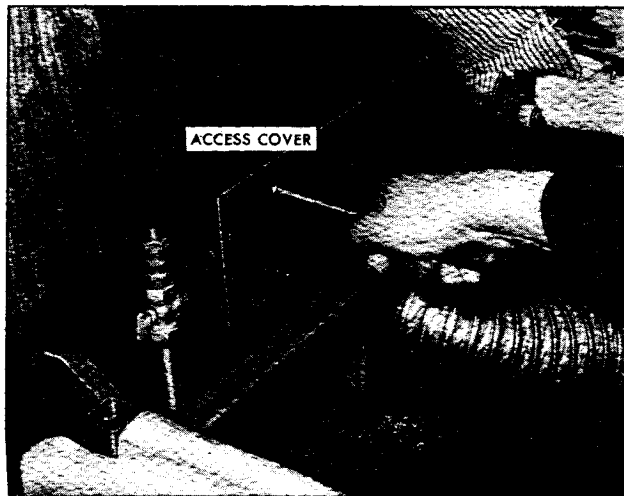

Removing Furnace Access Cover

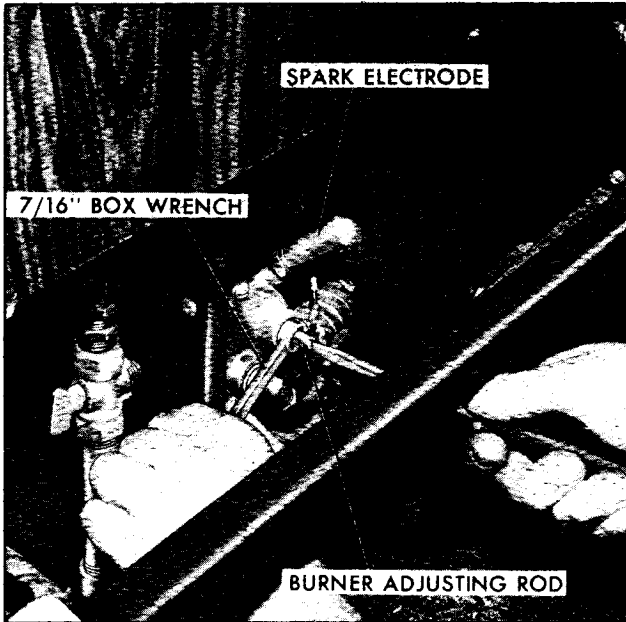

Furnace Primary Air Adjustment

NOTE: To gain access to right side of furnace (Model ZEO 6584), it will be necessary to remove service access panel in the compartment to the right of the furnace.

1. Loosen hex lock nut slightly until burner adjusting rod can be turned with a screwdriver.
2. Start furnace and watch burner through sight glass view port in plenum. Decrease primary air to give a slightly yellow flame with green cones. The cones are formed at each of the ports in the burner. Then increase air slowly until the yellow disappears and the cones become sharply defined as blue.

NOTE: The total adjustment available, from one extreme to the other, is only about 1/4 turn. Do not force adjusting rod past the stops.

3. Hold the adjusting rod in place and tighten the hex nut.
4. Recheck flame to see that it is still properly adjusted.

FURNITURE

DOUBLE DINETTE

The double dinette is adjustable and provides a normal sitting position, two intermediate sitting positions and a sleeping position.

NOTE: Use table leg to support dinette table when table is being used (as shown in dining position).

The double dinette easily converts to a double bed. To prepare the bed, take the following steps:

- Fold table leaves and push in supports (if so equipped).
- Slightly raise the aisle end of the table and depress folding leg lock and fold attached leg under all the way.
- Continue to raise the table end until it becomes disengaged from the wall.
- Place table on floor between dinette seats.



Double Dinette (Dining Position) (Typical)

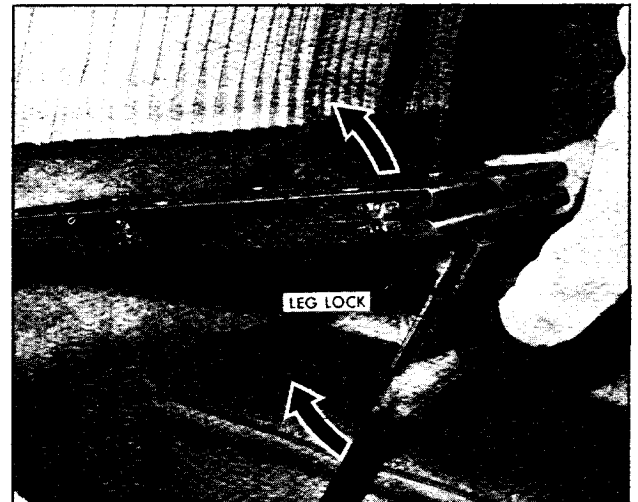

Dinette Table (Disengaging Legs)



Double Dinette (Converting to Sleeping Position)



Double Dinette (Sleeping Position)

NOTE: There are two handles located under seat cushion, one at each side of seat. Use of one handle should be sufficient when converting double dinette from sitting position to sleeping position and when converting double dinette from sleeping position to sitting position.

- Raise handle, located under seat cushion at aisle side of seat, and push seat back downward (as shown) and seat will slide into sleeping position. Repeat procedure on the opposite side.

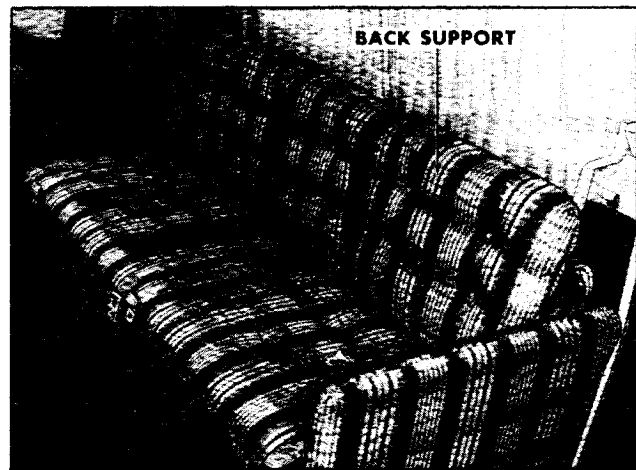

Front Davo

FRONT DAVO

The front davo converts into two bunk beds. To prepare the davo for sleeping, take the following steps:

- Swing the back support out from the wall.
- Unfold the additional section on the back support to bring it to full width.
- The two support straps can now be hooked to the recessed brackets provided in the ceiling (as shown).

NOTE: The area under the davo seat is a storage area. For access lift the seat and pull up the seat support at the forward side of the davo (as shown).

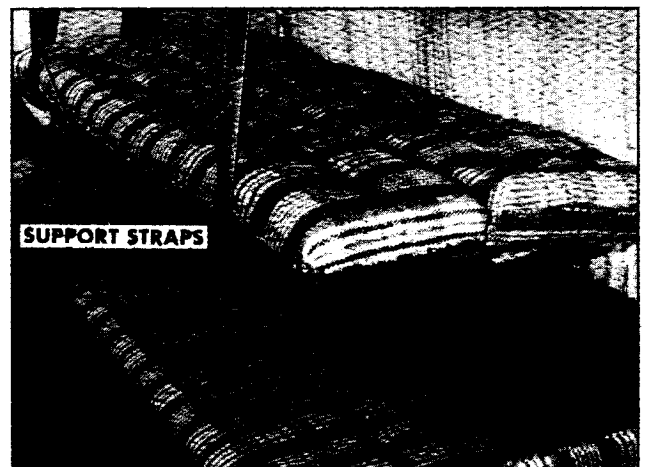

Front Davo (Converted to Bunk Beds)

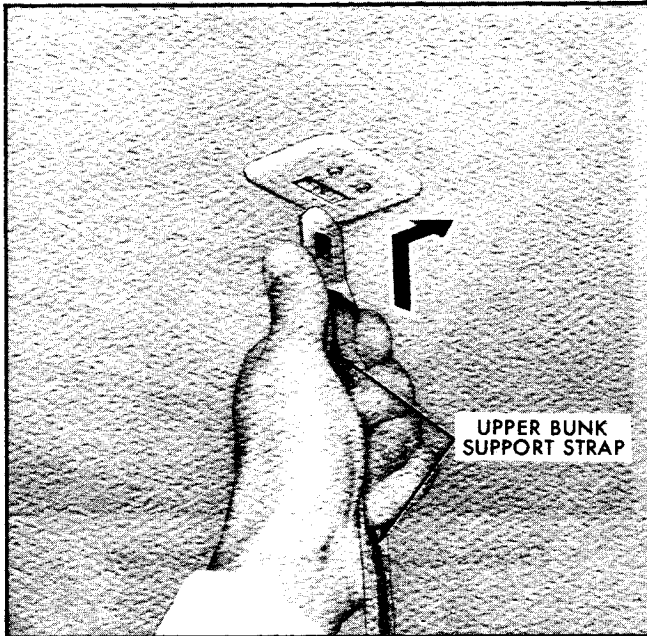

Connecting Upper Bunk Support Straps to Ceiling Brackets

SWIVEL CHAIRS

If the Motorhome is equipped with the swivel chairs in the living area, see **STARTING AND OPERATING** section earlier in this manual for lap belt and seat instructions.

CAUTION

Check that all swiveling seats are locked in position before driving off. If any seat swiveled during an accident the occupant may be more likely injured.



Side Facing Settee

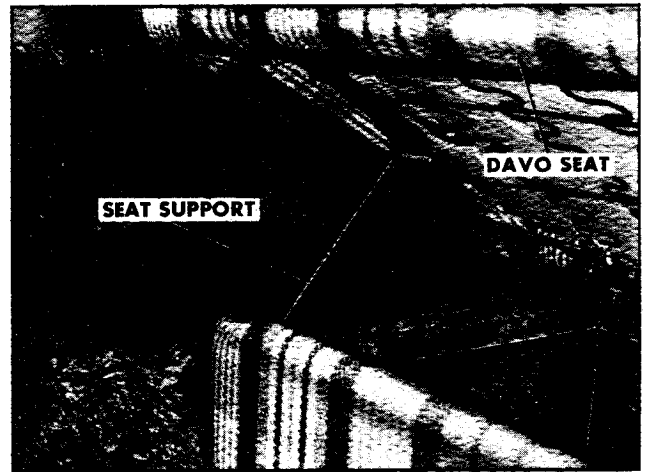

Davo Seat Support

SIDE FACING SETTEE

The rear side facing settee is adjustable and provides a normal sitting position, two intermediate sitting positions and a sleeping position. The rear side facing settee converts into a double bed for sleeping. To convert the side facing settee for sleeping perform the following:

- Raise forward edge of seat cushion, and push seat back downward (as shown) and seat will slide into sleeping position. Repeat procedure on the opposite side.
- To convert rear side facing settee back to seating position, grasp forward edge of seat cushion, and raise seat back upward and seat

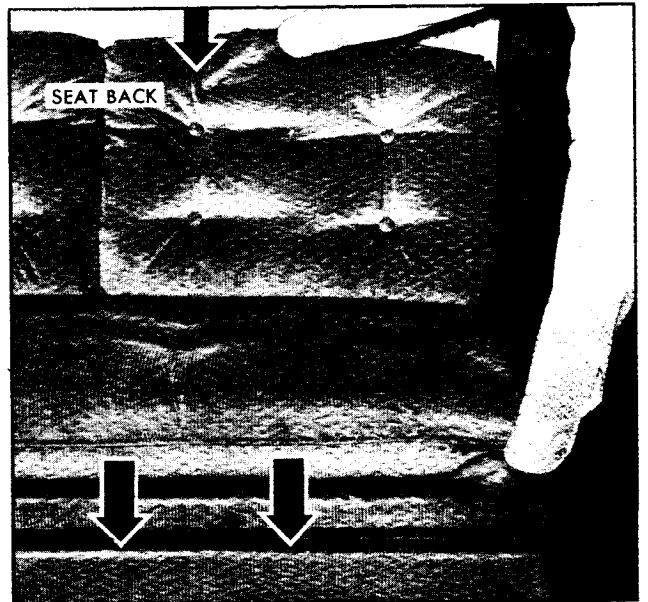

Preparing Settee for Sleeping

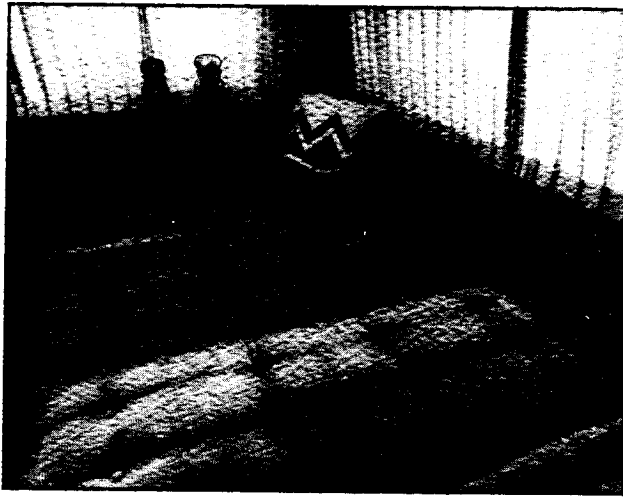

Settee in Sleeping Position

will slide into sitting position. Repeat procedure on the opposite side.

REAR DINETTE

The optional rear dinette can be converted into a double bed. To prepare the rear dinette for sleeping, perform the following:

- Pull the table and leg assembly out of the base mounted in the floor.
- Pull leg out of mounting hole under table top. Store the table top and leg on the floor in rear of Motorhome.
- To complete sleeping arrangement, follow procedure under "Side Facing Settee."

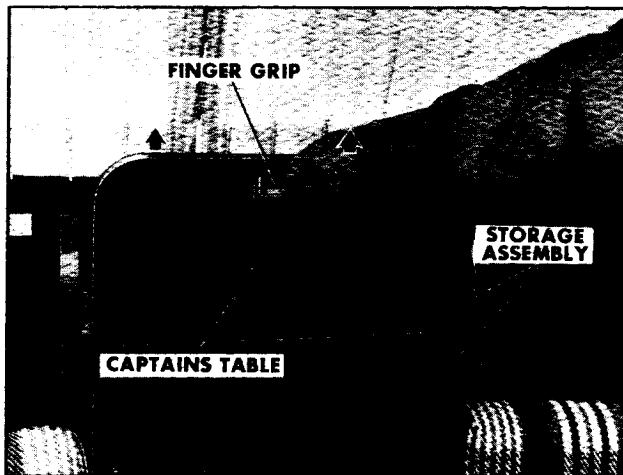

Removing Captain's Table from Storage Assembly

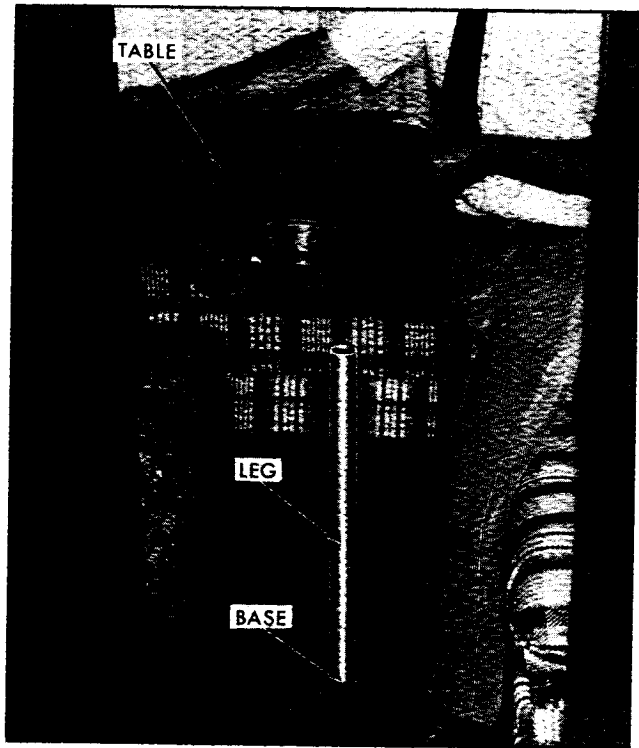

Rear Dinette

CAPTAIN'S TABLE

The Captain's table is stored in an assembly against the outer wall between the swivel seats. To use or store the table perform the following:

- Grasp the table at the finger grip and pull up until it stops. Lower the table down between the swivel seats.
- To store, lift the table up toward the windows, and lower it into the storage assembly.

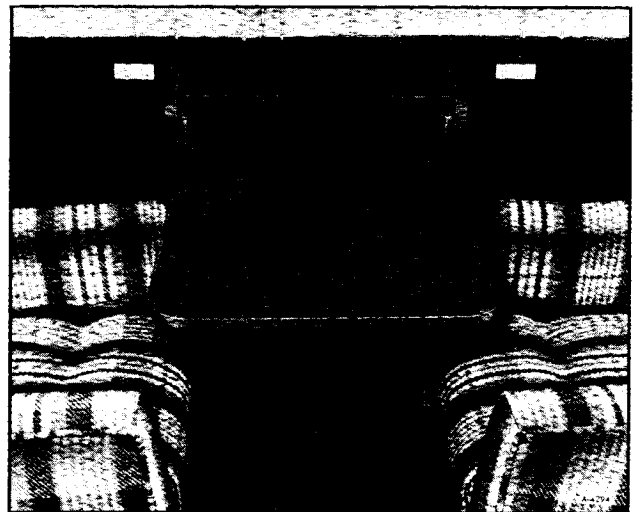

Captain's Table Positioned for Use



Removing Clock from Wall

DRIVER'S COMPARTMENT TABLE

The driver's compartment table can be stored by placing table at the right side of front passenger's seat. To use the table perform the following:

- Rotate the table leg away from the table top until it snaps into position and is locked.
- Hook the rear edge of the table on the moulding, mounted on the dash panel with the leg resting on the floor.
- To remove the table, lift upwards on the front edge of table and remove from moulding on dash panel. Depress latch, located at upper end of leg, and swing leg up against the underside of the table top.

ENTRANCE DOOR CLOSET

The entrance door closet located on your left, immediately, upon entering the Motorhome—contains the fire extinguisher and optional vacuum cleaner. The closet door is equipped with a special latch. To open the door, momentarily, apply pressure near its right edge, halfway between the top and bottom edge. The door latch is designed to pop open, when following the above instructions. Do not attempt to open door by pulling on the lower edge. To close the door, simply shut in the normal manner.

BATTERY-OPERATED CLOCK

The optional battery-operated wall clock is located above the kitchen range.

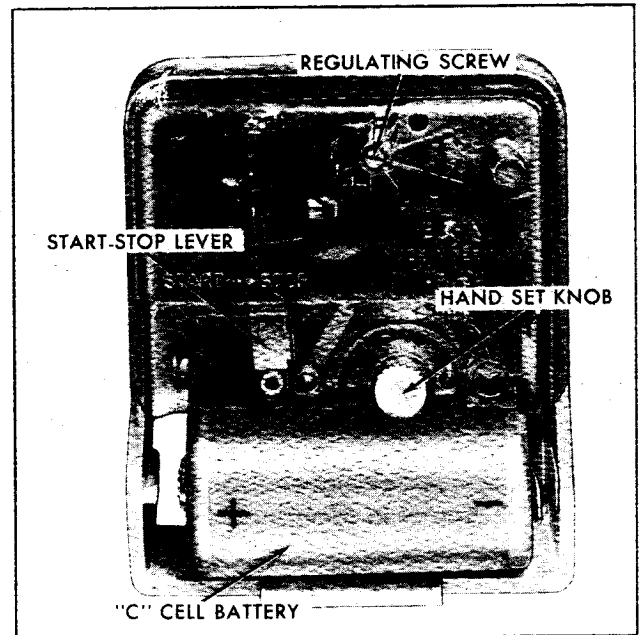

Backside of Clock

Battery Replacement

Remove clock from wall by raising approximately $\frac{1}{2}$ -inch, then carefully separate clock from wall. Remove and discard used battery. Install new $1\frac{1}{2}$ -volt "C" cell battery, being sure that positive (+) end of battery is installed as shown (when viewed from the back of clock).

Setting Hands

To set hands, pull Hand Set Knob slightly outward and rotate it **CLOCKWISE ONLY** (as viewed from front of clock). **NEVER** move the hands **COUNTERCLOCKWISE** as this may damage the mechanism.

Start Clock

To start clock, simply move the **START-STOP** lever to the left. If necessary to stop clock, move lever to the right.

Time Regulation

If clock is not maintaining proper time, it may be necessary to adjust position of regulating screw. Note the time movement cover is marked (+) and (-). If the clock runs fast, turn screw towards (-). If the clock runs slow, turn screw towards (+). A movement through one section (between slots) will adjust the timekeeping 5 seconds per day.

IN CASE OF EMERGENCY

FOUR-WAY HAZARD WARNING FLASHER

- Use the warning flasher to warn other drivers any time your vehicle becomes a traffic hazard, day or night.
- Avoid stopping on the roadway, if possible.
- Turn on the hazard warning flasher by pushing in on the button located on the column just below the steering wheel. Flasher can be actuated with engine ignition either off or on.
- Turn signals do not work with hazard flashers operating.
- If the brake pedal is depressed, the lights will not flash but remain continuously lit.
- To cancel the flasher, pull the button out.

EMERGENCY STARTING

- Engine cannot be started by towing or pushing the vehicle.
- If only main (automotive) battery is discharged, hold battery switch on instrument panel momentarily in "BAT BOOST." This supplies current from the auxiliary (living area) battery. After use switch is designed to return to the "BAT NORMAL" position.
- A vehicle with both batteries discharged may be started by using energy from a battery in another vehicle — a procedure called "Jump Starting."

JUMP STARTING

Jump starting done improperly may be dangerous and should be attempted **ONLY** if the following three conditions are met. If they are not, we strongly recommend that you leave the starting to a competent mechanic.

- **THE BATTERY IN THE OTHER VEHICLE:** must be 12-VOLT and **NEGATIVELY GROUNDED**, like the batteries in **THIS** vehicle. (Check the other vehicle's owner's manual to see if it is.)
- **THE BATTERY IN THIS VEHICLE:** must be equipped with **FLAME ARRESTOR TYPE FILLER/VENT CAPS** on **ALL** filler openings (as was the original-equipment Delco battery), or it must be a sealed-type battery

which does not have filler openings or caps. (Each Delco battery flame arrestor cap has a grey disc rather than a small hole—see illustration. If the battery does not have flame arrestor caps, or it is not a sealed-type battery, see "Alternate Procedure" before proceeding.)

- **IF THE BATTERY IS A DELCO SEALED-TYPE BATTERY:** without filler openings or caps, its charge or test indica-

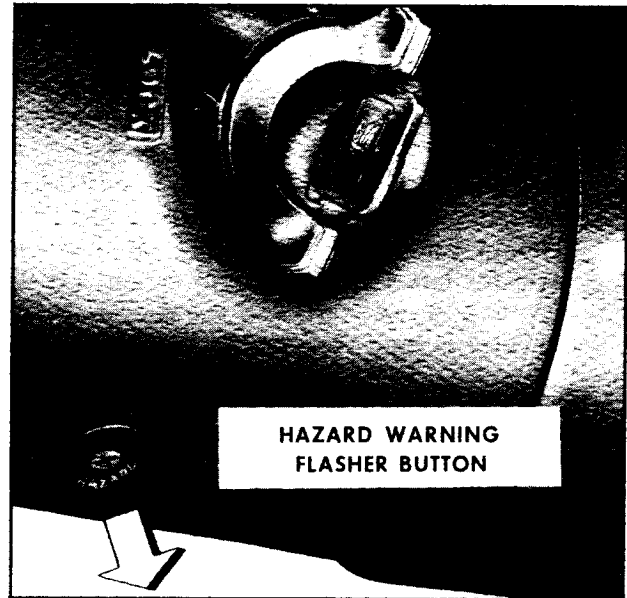

Hazard Warning Flasher

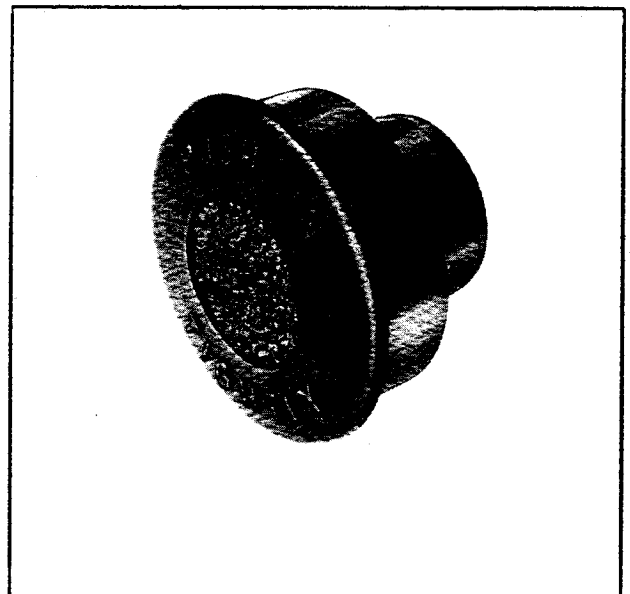

Flame Arrestor Cap

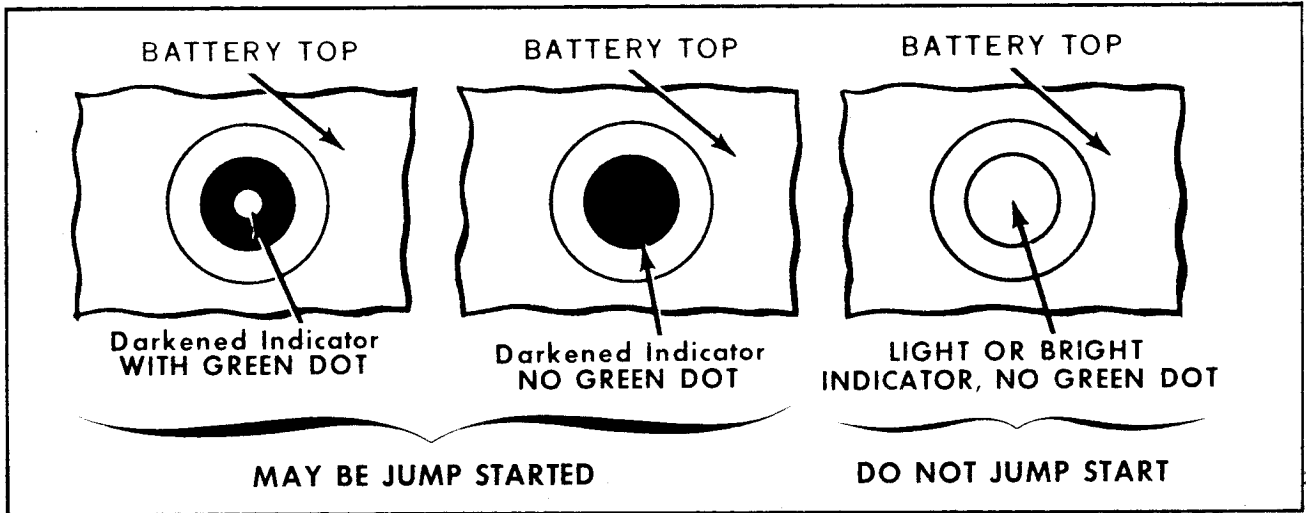

Charge or Test Indicator Conditions (Maintenance-Free Battery)

tor **MUST BE DARK**, with or without green dot showing, see illustration. Do **NOT** attempt jump starting if the charge or test indicator has a light or bright center. (If the vehicle will not start, and the charge or test indicator is light replace the battery.)

CAUTION
 Departures from these conditions or the procedure below could result in: (1) serious personal injury (particularly to eyes) or property damage from such causes as battery explosion, battery

acid, or electrical burns; and/or (2) damage to electronic components of either vehicle.

Never expose battery to open flame or electrical spark — batteries generate a gas which is flammable and explosive. Do not allow battery fluid to contact eyes, skin, fabrics, or painted surfaces — fluid is a corrosive acid. **FLUSH ANY CONTACTED AREA WITH WATER IMMEDIATELY AND THOROUGHLY.** Be careful that metal tools, or jumper cables do not contact the positive battery terminal (or metal in contact with it) and any other metal on the vehicle, because a short circuit could occur. Batteries should always be kept out of the reach of children.

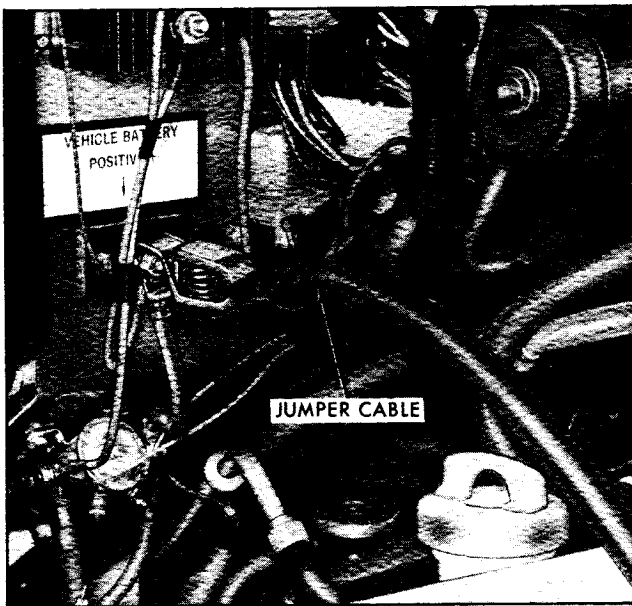

Connecting Jumper Cable to "VEHICLE BATTERY POSITIVE" Stud

JUMP START PROCEDURE

1. WEAR EYE PROTECTION and remove rings, metal watch bands, and other metal jewelry.
2. Set parking brake firmly, and place automatic transmission in "PARK" in both vehicles (**DON'T LET VEHICLES TOUCH**); and turn ignition key to LOCK in vehicle with discharged battery (Neutral and "OFF" in vehicles with manual transmission). Also turn off lights, heater, and all unnecessary electrical loads.
3. If either battery is so equipped, remove vent caps and check fluid level. If fluid level is OK, **REPLACE CAPS BEFORE PROCEEDING**; if

level is low, add drinking water, and **REPLACE CAPS BEFORE PROCEEDING**. If no water is available, leave caps off and cover filler openings with a cloth **BEFORE PROCEEDING**. Dispose of cloth and replace caps before jump starting.

4. Attach one end of a jumper cable to the positive terminal (identified by a red color, "+", or "P" on the battery case, post, or clamp), of the battery in the other vehicle and the other end of the same cable to positive terminal junction block stud, marked "VEHICLE BATTERY POSITIVE." This is located behind the right access door above the main (automotive) battery.

5. Attach one end of the remaining jumper cable **FIRST** to the negative terminal (black color, "-", or "N") of the **OTHER** vehicle's battery, (regardless of which vehicle has the discharged battery) and **THEN** to the right radiator mounting bracket in **THIS** vehicle—thus taking advantage of your battery's flame arrestor feature, should a spark occur.

6. Start the engine in the vehicle that is providing the jump start (if it was not running). Let run a few minutes, then start the engine in the vehicle that has the discharged battery.

7. Reverse the above sequence **EXACTLY** when removing the jumper cables, taking care to remove the cable from the right radiator mounting bracket in **THIS** vehicle as the **FIRST** step.

ALTERNATE PROCEDURE

If the battery in this vehicle has been replaced and does not have flame arrestor caps, or is not a sealed-type maintenance-free battery, one of the following alternatives should be followed.

- A. If the battery in the other vehicle is equipped with flame arrestors, follow the procedure above but make the final connection at the *other* vehicle's battery. Then when removing cables, remove connection first from the other vehicle's battery.
- B. If neither battery has flame arrestor caps, remove the filler/vent caps from the battery in this vehicle and place a disposable cloth over the filler openings. Follow the procedure above but make the final connection on this vehicle's right radiator mounting bracket.

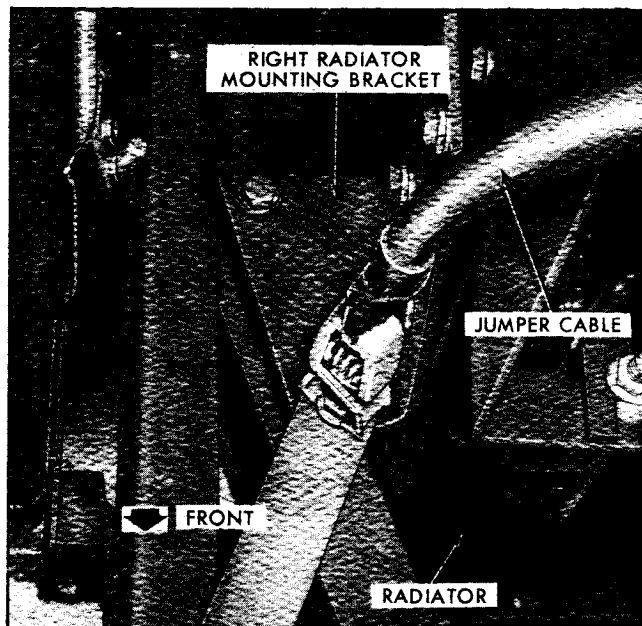

Connecting Jumper Cable to Right Radiator Mounting Bracket

ENGINE COOLANT

You might encounter a temporary cooling system overload during severe conditions, such as on hot days when pulling a long grade, when slowing down after high speed driving, after long idle periods in traffic jams or in these conditions when towing a trailer. If the hot light comes on and you have your air conditioning on, turn it off. When stopped in traffic, keep the transmission in neutral. If the light doesn't go off in about a minute, pull over to a secure place and put on your parking brake. Then place your transmission selector lever in "PARK." **DON'T TURN OFF THE ENGINE! INCREASE THE ENGINE IDLE** speed so it sounds like it's going twice as fast. Open the right front access door and check coolant level in coolant recovery tank. If low, check for fluid leaks at the radiator hoses, radiator or radiator overflow outlets. Check to see that all drive belts are intact and the fan is turning. The light should go off within one minute. If you are losing coolant or a fan belt is broken or loose and/or the red light persists, stop the engine until the cause of overheating is corrected. After the light is out, following temporary cooling system overload, proceed on the highway at a reduced speed. About ten minutes later, resume normal driving.

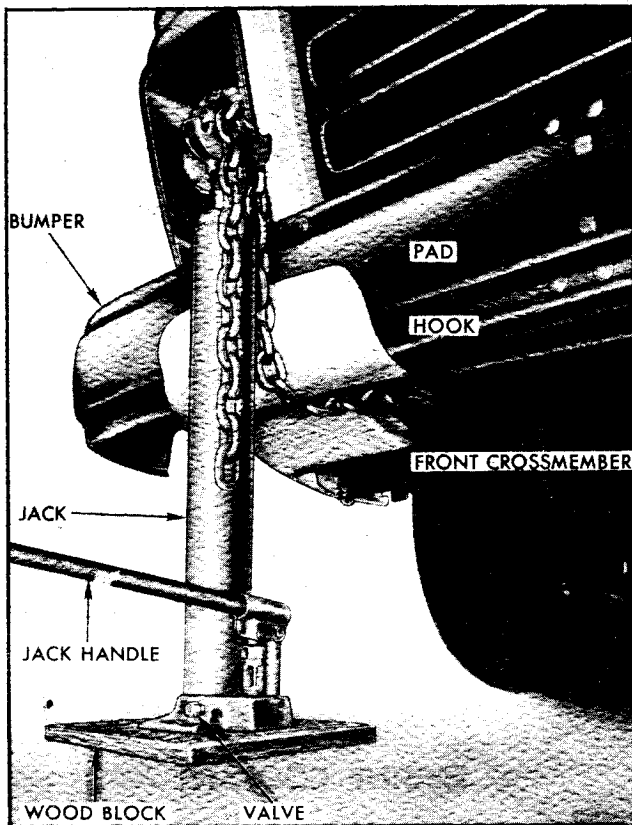

Jacking at Front of Vehicle

CAUTION

- To help avoid the danger of being burned, do not remove radiator cap while engine and radiator are still hot, because the cooling system will blow out scalding fluid and steam under pressure.
- Do not remove radiator cap to check engine coolant level; check coolant visually at the "see-through" coolant tank.
- Proper coolant level at normal engine operating temperature is between the "FULL" and "ADD" marks on the tank.
- Coolant should be added only to the coolant recovery tank (see SERVICE & MAINTENANCE section for details).

JACK USAGE INSTRUCTIONS

CAUTIONS

1. Follow jacking instructions in order to reduce the possibility of serious personal injury.
2. The jack is designed for use only when changing wheels.

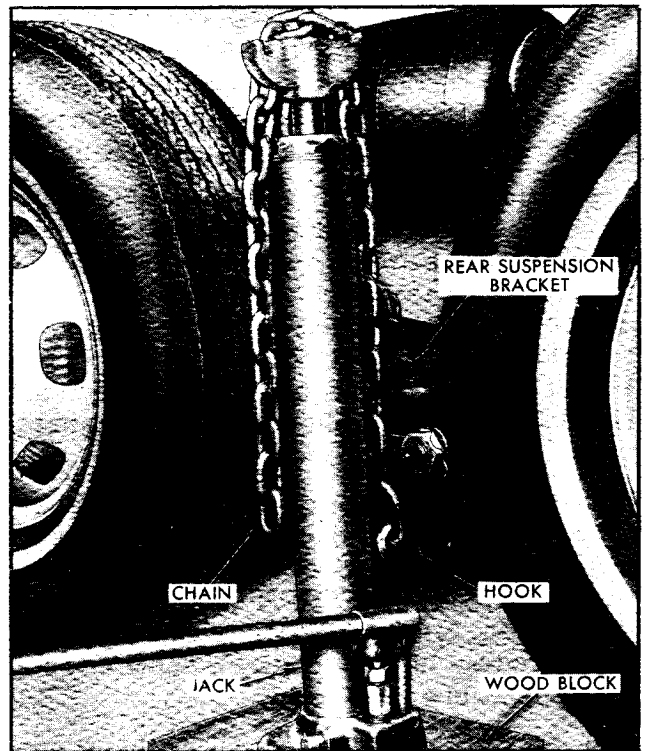

Jacking at Rear of Vehicle

3. Never get beneath the vehicle when using jack.

4. Do not start or run engine while vehicle is on jack.

INSTRUCTIONS

NOTE: The jack is located under the rear facing dinette seat or davo seat, located behind the front passenger seat.

- Park on level surface and set parking brake firmly.
- Park on level surface and set parking brake firmly.
- Set automatic transmission in "PARK."
- Activate hazard warning flasher.
- Remove wheel opening cover if equipped.
- Block both front and rear of the wheel diagonally opposite the jack position.
- Loosen but do not remove wheel nuts.

JACKING AT FRONT—Place hydraulic jack on wood block near front bumper bracket. Place hook at flange front cross-member. Pass chain under bumper and adjust chain length to snug fit on fork on top of jack.

JACKING AT REAR—Remove fender skirt, if vehicle is so equipped using a No. 2 cross-recessed screwdriver and 9/16" wrench or socket (as shown). Place hydraulic jack on wood block close to rear suspension bracket (see illustration). The hook is placed in the drainage slot under bracket. Adjust chain length so link will fit in fork at top of jack.

- Close valve at base of jack and insert jack handle.
- Always operate jack with slow, smooth motion.
- Raise vehicle so tire just clears surface, replace wheel and slightly tighten wheel nuts.
- Open valve at base of jack to lower, then fully tighten wheel nuts. **Proper torque is 250 foot pounds.**

CAUTION

Use lug wrench provided to tighten wheel nuts securely. (Follow the nut tightening sequence shown in the **SERVICE AND MAINTENANCE** section.) At the earliest opportunity have wheel nut torque checked. This is necessary to help prevent loosening or stripping of the wheel nuts.

Always securely restow the spare tire assembly (if so equipped) on the spare tire carrier, and return all jacking equipment to its proper stowage location. These precautions will help prevent such items from becoming dangerous projectiles in the event of an accident.

NOTICE: A tire that is run while significantly underinflated will overheat, possibly resulting in a fire that may seriously damage the vehicle and its contents.

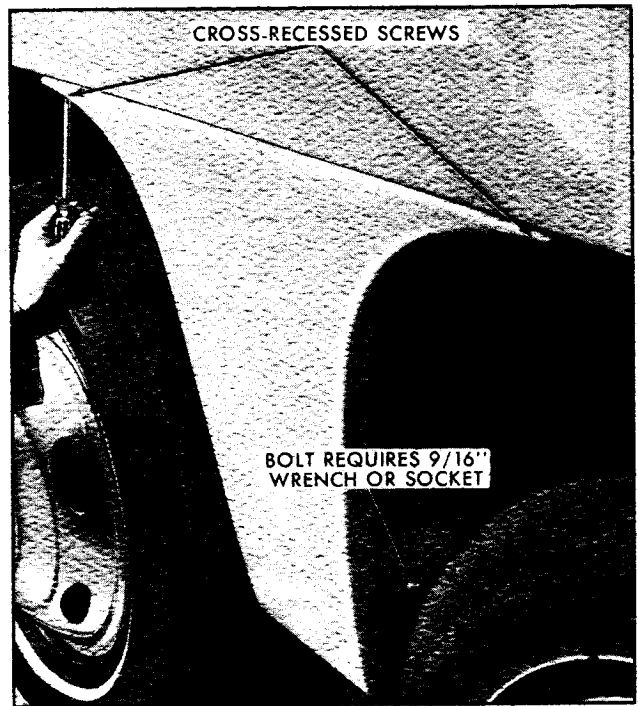

Removing Fender Skirt

TOWING

Proper lifting and towing equipment is necessary to prevent damage to the vehicle during any towing operation. State (Provincial in Canada) and local laws applicable to vehicles to tow must be followed. Detailed towing instructions are available at your Motorhome dealer.

Your vehicle may be towed on all six wheels, at speeds less than 35 mph (56 km/h), for distances up to 50 miles, provided the final drive, axle, transmission, and steering system are otherwise normally operable. Use only towing equipment specifically designed for this purpose following the instructions of the towing equipment manufacturer. A separate safety chain system must be used. For such towing the steering must be unlocked, transmission in neutral and the parking brake released. Attachments must be to engine front crossmember. Do not attach to bumpers or associated brackets. Remember that power brakes and power steering assists will not be available when engine is inoperative.

TOWING AT FRONT

On vehicles equipped with the Electro-Level System, be sure the **TRAVEL** switch (located to

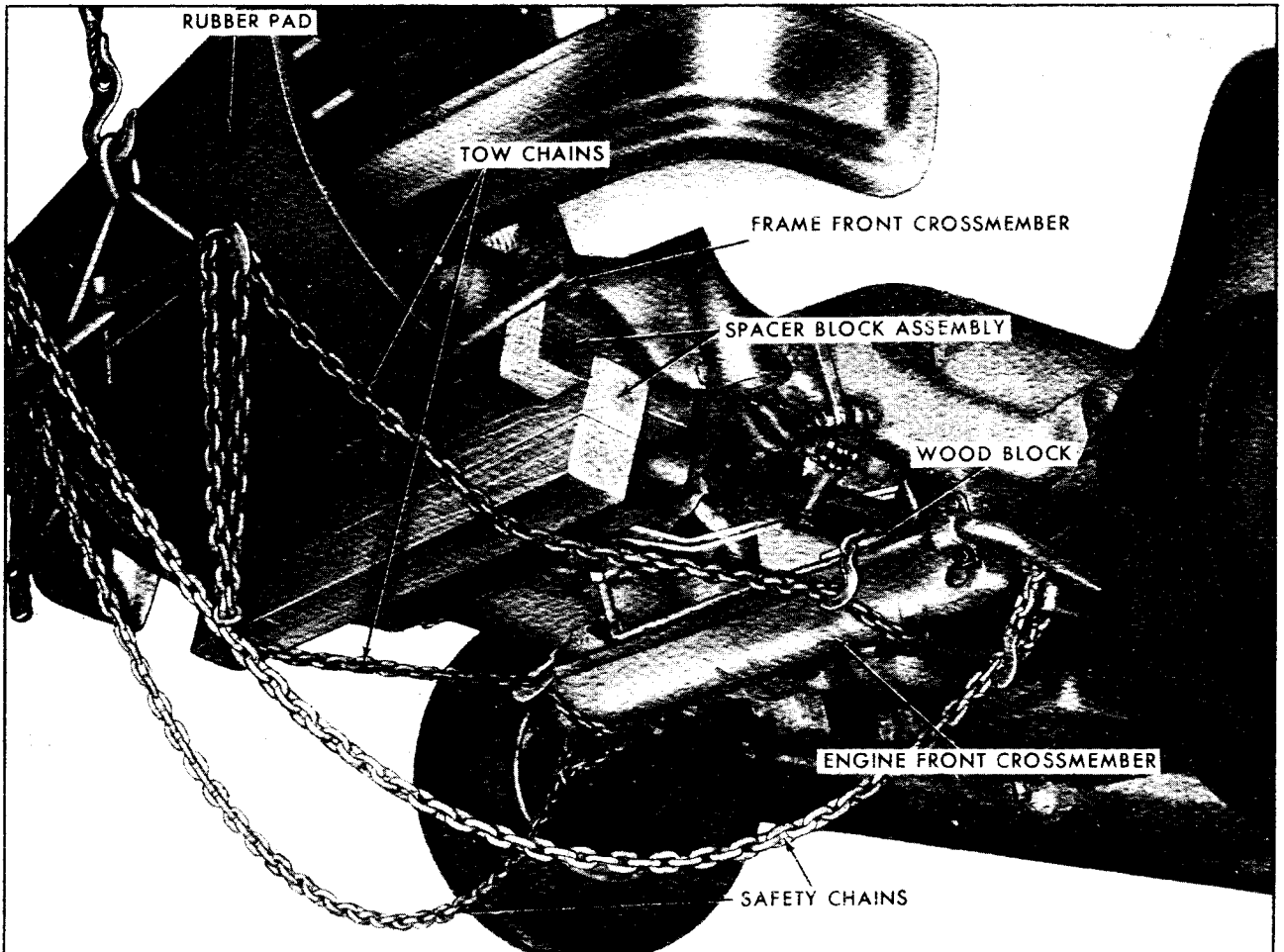

Towing Vehicle

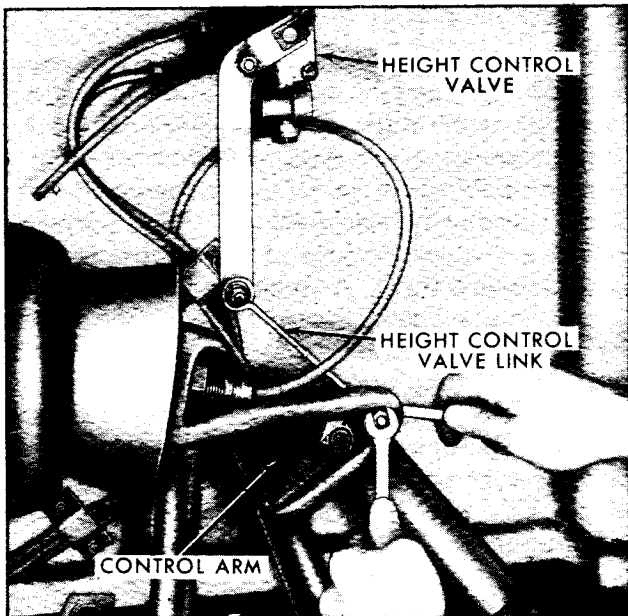

Disconnecting Height Control Valve Link

the left of driver) is moved to "HOLD" position, thereby making the automatic height valves inoperative on the rear suspension. On vehicles not equipped with the optional Electro-Level System, it will be necessary to disconnect the height control valve link at the rear suspension control arm (adjacent to the shock absorber stud) on each side of the vehicle. Raising front of vehicle so front wheels are four inches off the ground will provide about five-inch ground clearance at the rear when towing.

TOWING AT REAR

It is not recommended that vehicle be towed with the rear raised as this could result in suspension or crossmember damage.

FREEING VEHICLE FROM SAND, ETC.

If it becomes necessary to rock the Motorhome to free it from sand, mud, or snow, move the transmission selector lever from "D" to "R"

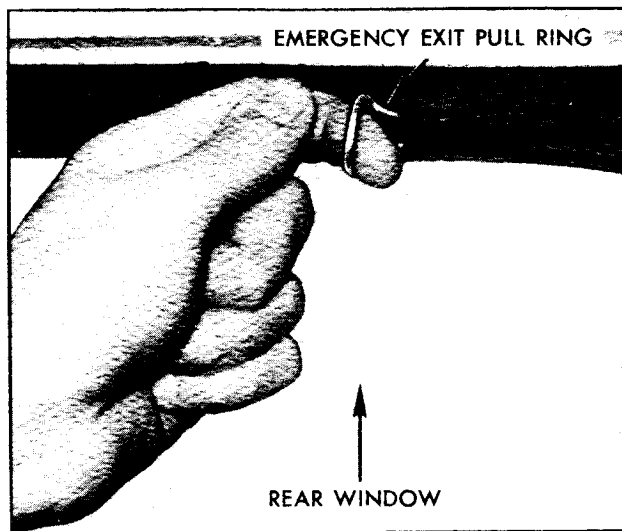

Emergency Exit Pull Ring

in a repeat pattern while simultaneously applying moderate pressure to the accelerator. Do not race engine. For best possible traction, avoid spinning wheels when trying to free the vehicle. The use of AC Liquid Tire Chain is recommended for temporary assistance when traction is lost on ice or snow.

CAUTION

Do not spin wheels in excess of 35 mph (56 km/h) as indicated on the speedometer or for more than 3 minutes at a time. Personal injury and severe damage may result from excessive wheel spinning including transmission overheating, tire disintegration or differential failure.

EMERGENCY EXIT

The rear window of the vehicle in an emergency can be used as an exit. To use the emergency exit, pull the ring located at the top center

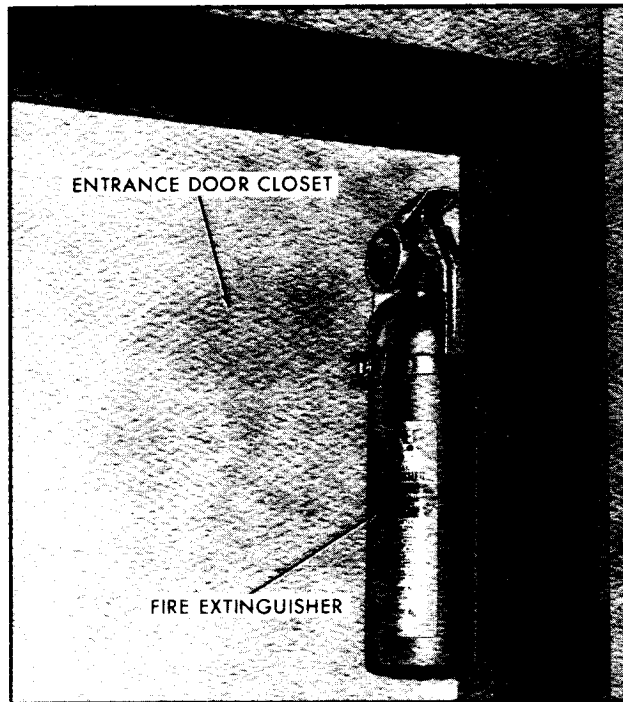

Location of Fire Extinguisher (Typical)

of the rear window until window seal is removed, and then push the glass out of the frame. Do not pull ring except in case of emergency. The window is not hinged, and it is designed to be pushed out. Take care that window will not fall on anyone outside the vehicle. Be careful of possible broken glass on ground when exiting from the vehicle.

FIRE EXTINGUISHER

The dry chemical, fire extinguisher is located in the entrance door closet or in the galley overhead cabinet.

It is recommended that you be familiar with the operating instructions located on the fire extinguisher.

GMC MOTORHOME NOTES

APPEARANCE CARE

CARE AND CLEANING OF INTERIOR

IMPORTANT: Be sure vehicle is well ventilated while using any cleaning agents. Follow manufacturer's recommendations in using such products. Also to avoid possible permanent discoloration on white or light colored seat trim **DO NOT** allow materials with unstable dyes (certain types of casual clothing, such as colored denims, corduroys, leathers and suedes; also decorative paper, etc.) to come in contact with seat trim materials.

With the advent of modern trim materials composed of synthetic plastics and/or man made fibers, it is **EXTREMELY IMPORTANT** that proper cleaning techniques and cleaners be used when cleaning interior trim. Failure to do this on the first cleaning may result in water spots, spot rings, setting of stains or soilage, all of which make it more difficult or impossible to remove in a second cleaning.

Certain portions of the following cleaning instructions are in bold type; they are particularly important and **must** be performed.

Dust and loose dirt that accumulates on interior fabric trim should be removed frequently with a vacuum cleaner, whisk broom or soft brush. Vinyl or leather trim should be wiped regularly with a clean damp cloth. Normal trim soilage, spots or stains can be cleaned with the following G.M. cleaners.

Description	Part No.
G.M. Spot Lifter - 8 oz. Solvent Type	1051398
G.M. Multi-Purpose Powdered Cleaner 6 lbs. Foam Type	1050429

The above cleaners are **EXCELLENT CLEANERS** when used properly according to directions on containers and are available through the G.M. Parts System.

NEVER use gasoline, nail polish remover or acetone, lacquer thinners, bleaches, etc. Some basic steps should be remembered before the cleaning is attempted:

1. Remove stains as quickly as possible before they become "set."

2. Use a clean cloth or sponge and change to a clean area frequently. (A **SOFT** brush may be used if stains persist.)
3. Use solvent type cleaners in a well ventilated area, also, do not saturate the stained area.
4. If a ring should form after spot cleaning, the entire area of the trim assembly should be cleaned **IMMEDIATELY**.
5. Follow instructions on the label of the cleaner.

CAUTION

Many cleaners may be toxic or flammable, and their improper use may cause personal injury or may cause damage to the interior. Therefore, when cleaning the interior, do not use volatile cleaning solvents such as acetone, lacquer thinners, enamel reducers, nail polish removers, or such cleaning materials as laundry soaps, bleaches or reducing agents (except as noted in the adjacent fabric cleaning instructions on stain removal). Never use carbon tetrachloride, gasoline or naphtha for any cleaning purpose.

KITCHEN SINK

The stainless steel sink should be cleaned with a liquid or finely ground powder. Scouring powder is not recommended for stainless steel and will ruin the finish. Stainless steel cannot be harmed by boiling water. However, salt, mustard, mayonnaise and catsup will cause pitting and should be cleaned off immediately.

VACUUM CLEANER

The Motorhome integral vacuum cleaner (if equipped) operates on 120-volt current. The vehicle must be connected to an external power source or the motor generator must be in operation in order to operate the vacuum cleaner.

Vacuum cleaner components are stored in the entrance door closet. The closet contains a long flex hose, wand, and a wide assortment of wand attachments including one for shag carpeting.

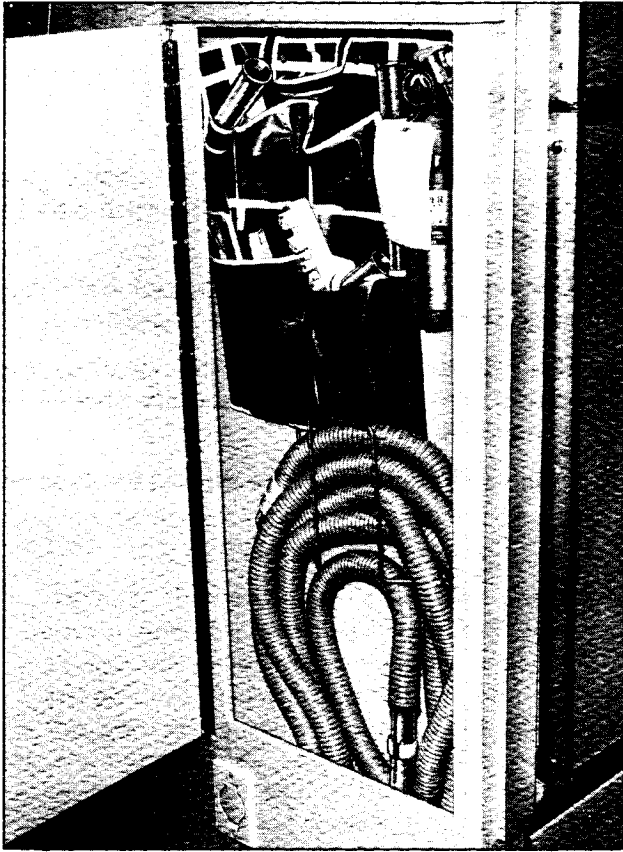

*Connecting Flex Hose to Wall Socket
(ZEO 6581)*

To operate the vacuum system, remove flex hose from the closet, lift vacuum inlet hinge cap, just under the entrance door closet (ZEO 6581), and insert the proper end of the flex hose. At this point the vacuum system will be operat-

ing and is used in the same manner as any household vacuum cleaner.

NOTE: And model ZEO 6584 the vacuum cleaner plug is located in the toe board below the refrigerator.

DRAPERY CARE

The draperies used in the GMC Motorhome are to be **DRY CLEANED ONLY**.

CLEANING GENERAL SOILAGE OR WATER SPOTS FROM FABRIC TYPE TRIM WITH FOAM TYPE CLEANER

G.M. Multi-Purpose Powdered Cleaner is excellent for this type cleaning and for cleaning a panel section where a minor cleaning ring may be left from spot cleaning.

Vacuum area thoroughly to remove excess loose dirt. **ALWAYS** clean a full trim assembly or complete section-mask adjacent trim along stitch or welt lines. Mix Multi-Purpose Powdered Cleaner in strict accordance with directions on label of container—mix proportionally for smaller quantities. **Use suds only on a clean sponge or soft bristle brush — Do NOT wet fabric excessively or rub harshly with brush. Immediately after cleaning, wipe off any cleaner residue with slightly damp absorbent towel or cloth.**

IMPORTANT — Immediately after wiping, force-dry fabric with air hose, heat dryer or heat lamp. (Use caution with heat dryer or heat lamp to prevent damage to fabric.) When trim materials with a sheen or luster finish are dry, wipe fabric lightly with a soft, dry clean cloth to restore sheen or luster.

SPOT CLEANING FABRIC TYPE TRIM MATERIALS WITH SOLVENT TYPE CLEANER

Before attempting to remove spots or stains from fabric, determine as accurately as possible the nature and age of the spot or stain. Some spots or stains can be removed satisfactorily with water or mild soap solution (refer to accompanying "Removal of Specific Stains"). For best results, spots or stains should be removed as soon as possible. Some types of stains or soilage such as lipstick, some inks, certain types of grease, etc.,

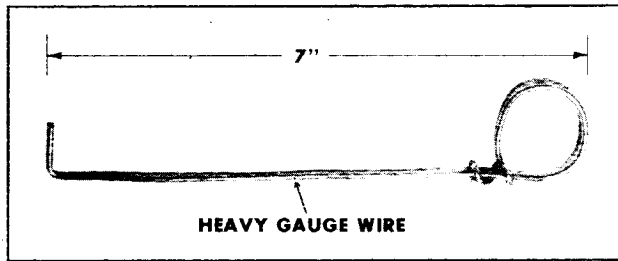

Screen Track Removal Tool

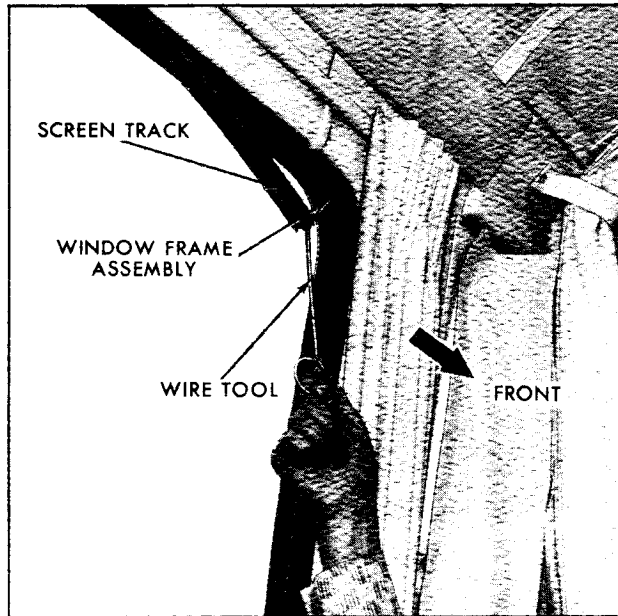

Separating Track from Window Frame Assembly

are extremely difficult and, in some cases, impossible to completely remove. When cleaning this type of stain or soilage, care must be taken not to enlarge the soiled area. It is sometimes more desirable to have a small stain than an enlarged stain as a result of careless cleaning.

G.M. Fabric Cleaner (Solvent Type) is excellent for spot cleaning stains containing grease, oil or fats from fabric type trim. Excess stain should be gently scraped off trim material with a clean, **DULL** knife or scraper. **USE VERY LITTLE CLEANER**, light pressure, and clean cloths (preferably cheese cloth). Cleaning action should be from outside of stain **FEATHERING** towards center of stain and constantly changing to a clean section of cloth. When stain is cleaned from fabric, immediately dry area with an air hose, heat dryer or heat lamp to help prevent a cleaning ring (use caution with heat dryer or heat lamp to prevent damage to fabric material). If a ring forms, immediately repeat the cleaning opera-

tion over a slightly larger area with special emphasis on **FEATHERING** towards center of area. If ring still persists, mark off adjacent trim sections and clean entire affected trim panel section with G.M. Multi-Purpose Powdered Cleaner as previously described under "cleaning general soilage or water spots with foam type cleaner."

REMOVAL OF SPECIFIC STAINS

GREASE OR OIL STAINS – Includes grease, oil, butter, margarine, shoe polish, coffee with cream, chewing gum, cosmetic creams, vegetable oils, wax, crayon, tar and asphalts. Carefully scrape off excess stain; then use Fabric Cleaner (Solvent Type) as previously described. Shoe polish, wax, crayons, tar and asphalts will stain if allowed to remain on trim; they should be removed as soon as possible – use caution as cleaner will dissolve them and may cause them to bleed.

NON-GREASY STAINS – Includes catsup, coffee (black), egg, fruit, fruit juices, milk, soft drinks, wine, vomit and blood. Carefully scrape off excess stain; then sponge stain with cool water. If stain remains, use Multi-Purpose Powdered Cleaner (Foam Type) as previously described. If odor persists after cleaning vomitus or urine, treat area with a water-baking soda solution – 1 teaspoon baking soda to 1 cup of warm water – finally, if necessary, clean lightly with Fabric Cleaner (Solvent Type).

COMBINATION STAINS – Includes candy, ice cream, mayonnaise, chili sauce and unknown stains. Carefully scrape off excess stain; then clean first with *cool* water and allow to dry. If stain remains, clean with Fabric Cleaner (Solvent Type).

CLEANING VINYL OR LEATHER TRIM

Ordinary soilage can be removed from vinyl or leather with warm water and a mild soap such as saddle soap or oil soap, or approved equivalent. Apply a small amount of soap solution and allow to soak for a few minutes to loosen dirt; then, rub briskly with a clean, damp cloth to remove dirt – and soap residues – this operation may be repeated several times if necessary. Some soilage such as tars, asphalts, shoe polish, etc. will stain if allowed to remain on trim – they should be wiped off as quickly as possible and the area cleaned with a clean cloth dampened with G.M. Vinyl Cleaner (Solvent Type).



Removing Screen Track

BELT RESTRAINT CARE

- Clean only with mild soap solution and lukewarm water.
- Do not bleach or dye belts since this may severely weaken belts.

GLASS SURFACES

The glass surfaces should be cleaned on a periodic basis for continued good visibility. Use of G.M. Glass Cleaner or a commercial household glass cleaning agent containing ammonia will remove normal tobacco smoke and dust films sometimes caused by ingredients used in vinyls, plastics or other interior trim materials.

NOTICE: Never use abrasive cleaners on any vehicle glass, as it may cause scratches.

WINDOW SCREEN REMOVAL

To aid in cleaning interior glass on your vehicle, the horizontal sliding window screens may be removed as follows:

IMPORTANT: To help avoid damaging screen track, **DO NOT** remove screen before removing screen track.

1. Remove upper screen track using a reasonably stiff wire shaped to form the screen track removal tool (as shown), Insert tool at outer end of screen track and separate track from

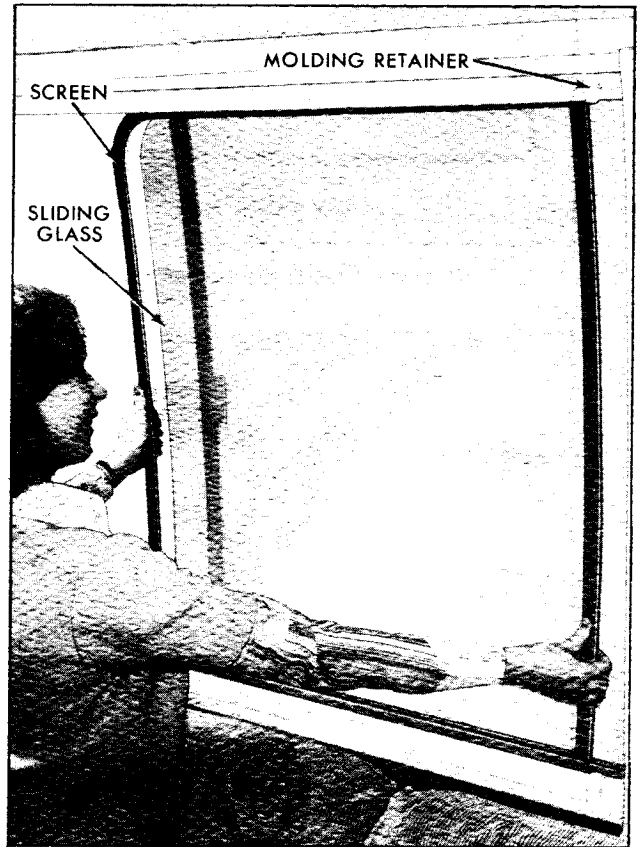

Removing Window Screen

window frame assembly. Grasp track and pull completely free of window assembly.

2. Unlock window, slide glass and screen forward almost to moulding retainers.

3. Lift screen up into window frame assembly. Pull bottom of screen away from window and remove screen.

WINDOW SCREEN INSTALLATION

1. To install screen, lift screen up into window frame assembly. Slide screen fully rearward.

2. Note that screen track when installed contacts the inner edge of sliding window track. The screen track has three grooves, and the widest groove should face the outside of the vehicle. Position screen track in window frame assembly and slide it rearward, until contact is made with adjacent upper screen track. Seat track into position by pressing track firmly up into window frame assembly.

3. Slide screen back and forth several times to assure proper sealing of track. If screen will not slide, track is binding. Using a small wood block and mallet, carefully tap the track firmly into position.

CAUTION

DO NOT use a screwdriver to install screen track. The screwdriver may fracture the window glass.

EXTERIOR APPEARANCE CARE

The acrylic finish on your vehicle provides maximum beauty, depth of color, gloss retention and durability.

WASHING

The best way to preserve this finish is to keep it clean by frequent washings. Wash the vehicle in lukewarm or cold water.

Do not use hot water or wash in the direct rays of the sun. Do not use strong soap or chemical detergents. All cleaning agents should be promptly flushed from the surface and not allowed to dry on the finish.

POLISHING AND WAXING

Polishing is recommended to remove accumulated residue and eliminate any "weathered" appearance.

Your GMC Motorhome dealer offers several polishes and cleaners which have proven value in maintaining original finish appearance and durability.

NOTE: Some chemical cleaners, used for removing road oil and tars from painted surfaces, are detrimental to acrylic enamel finishes. When purchasing a cleaner, make sure the instructions on the container specifically state that the contents can be used on any acrylic enamel finish.

PROTECTION OF EXTERIOR BRIGHT METAL PARTS

Bright metal parts should be cleaned regularly to maintain luster. Washing with water is all that is usually required. However, G.M. Chrome Polish may be used on **CHROME** or **STAINLESS STEEL** trim if necessary.

Use special care with **ALUMINUM** trim. Never use auto or chrome polish, steam or any caustic soap to clean aluminum. A coating of wax, rubbed to a high polish, is recommended for all bright metal parts.

FOREIGN MATERIAL DEPOSITS

Calcium chloride and other salts, ice melting agents, road oil and tar, tree sap, bird droppings,

chemicals from industrial chimneys and other foreign matter may damage automobile finishes if allowed to remain on painted surfaces.

Prompt washing may not thoroughly remove all of these deposits. Additional cleaners may be required. When using chemical cleaners designed for this purpose, be certain they are safe for use on acrylic painted surfaces.

FINISH DAMAGE

Any stone chips, fractures or deep scratches in the finish should be repaired promptly. Exposed metal will corrode quickly and may develop into major repair expense.

Minor chips and scratches can be repaired using touch-up materials available from your GMC Motorhome dealer. Larger damages to the finish can be corrected in your dealer's body and paint shop facility.

CLEANING WHITE SIDEWALL TIRES

Use GM White Sidewall Tire Cleaner or a tire cleaner which will not harm aluminum trim. A stiff brush may be used with the cleaner to remove road grime and dirt from white sidewall tires.

UNDERBODY MAINTENANCE

Corrosive materials used for ice and snow removal and dust control accumulate on the underbody. If allowed to remain, these materials can result in accelerated rusting and deterioration of underbody components such as fuel lines, frame and floor pan, exhaust system, etc. At least once each year, preferably after a winter's exposure these corrosive materials should be removed by flushing the underbody with plain water. Particular attention should be given to cleaning out those areas where mud and other foreign materials collect.

If desired, your GMC Motorhome dealer can perform this service for you. In addition, he can provide recommendations on undercoating materials which will help protect your vehicle from corrosion.

UNDERCOATING

Due to the fiberglass and aluminum body construction of the vehicle added protection by additional undercoating is not necessary. How-

ever, if you do wish to apply undercoating material, it should be kept off of all moving or rotating parts. It should also be kept off air conditioner fittings, body drain holes, exhaust systems, and plumbing.

GM VEHICLE CHEMICALS

<u>Part Number</u>	<u>Size</u>	<u>Description</u>	<u>Usage</u>
1050001	16 oz.	Washer Solvent and Gas Line De-icer	Windshield washing system and gas line
1050017	32 oz.	Power Steering Fluid	Power Steering
1050019	16 oz.	Spray-A-Squeak	Weather Strips—stops squeaks on metal to metal and metal to rubber contact
1052103	1 gal.	Permanent Type Coolant and Anti-Freeze	Year round coolant and anti-freeze
1050172	16 oz.	Tar and Road Oil Remover	Removes old waxes, polishes, tar, and road oil
1050173	16 oz.	Chrome Cleaner and Polish	Removes rust and corrosion on chrome and stainless steel
1050174	16 oz.	White Sidewall Tire Cleaner	Cleans white and black tires
1050223	16 oz.	Finish Guard Cleaner	One step cleaner and wax
1050422	12 oz.	Heat Valve Lubricant	Free up sticky heat risers — general purpose penetrant
1050427	23 oz.	Glass Cleaner	Glass cleaning and spot cleaning on vinyls
1050520	16 oz.	Lubriplate (White Grease)	Grease for hood, trunk and door hinges and latches
1050729	8 oz.	Vinyl Top Cleaner	Cleaning of vinyl tops
1050429	6 lb.	Multi Purpose Powdered Cleaner	Cleans vinyl and cloth on door trim, seats, and carpet, also tires and mats
1051398	8 oz.	Spot Lifter	Spot and stain removal on cloth and fabric
1051515	32 oz.	Optikleen	Windshield washer solvent and anti-freeze
1015516	32 oz.	Washer Solvent and Gas Line De-Icer	Same as 1050001
1051772	20 oz.	Presoftened Cleaner/Wax	One step cleaner/wax
1051855	32 oz.	Dexron® II	Automatic Transmissions and Five Speed Manual Transmissions
1051858	16 oz.	G.M. Super E.O.S.	Consult your Dealer for specific usage
1050244	16 oz.	Fabric Cleaner	Spot and stain removal on cloth and fabric
1050214	32 oz.	Vinyl/Leather Cleaner	Spot and stain removal on vinyl or leather

SERVICE AND MAINTENANCE

CAUTION

As with any machinery, care should be taken when performing any inspection, maintenance or repair so as to prevent accidental injury. Improper or incomplete servicing could also result in vehicle operational problems which may lead to serious personal injury, or damage to the vehicle or its equipment. Should you have any question about performing any service, have the service performed by a competent serviceman.

This vehicle contains some parts dimensioned in the metric system as well as in the customary system. Some fasteners are metric and are very close in dimension to familiar customary fasteners in the inch system. It is important to note that, during any vehicle maintenance procedures, replacement fasteners must have the same measurements and strength as those removed.

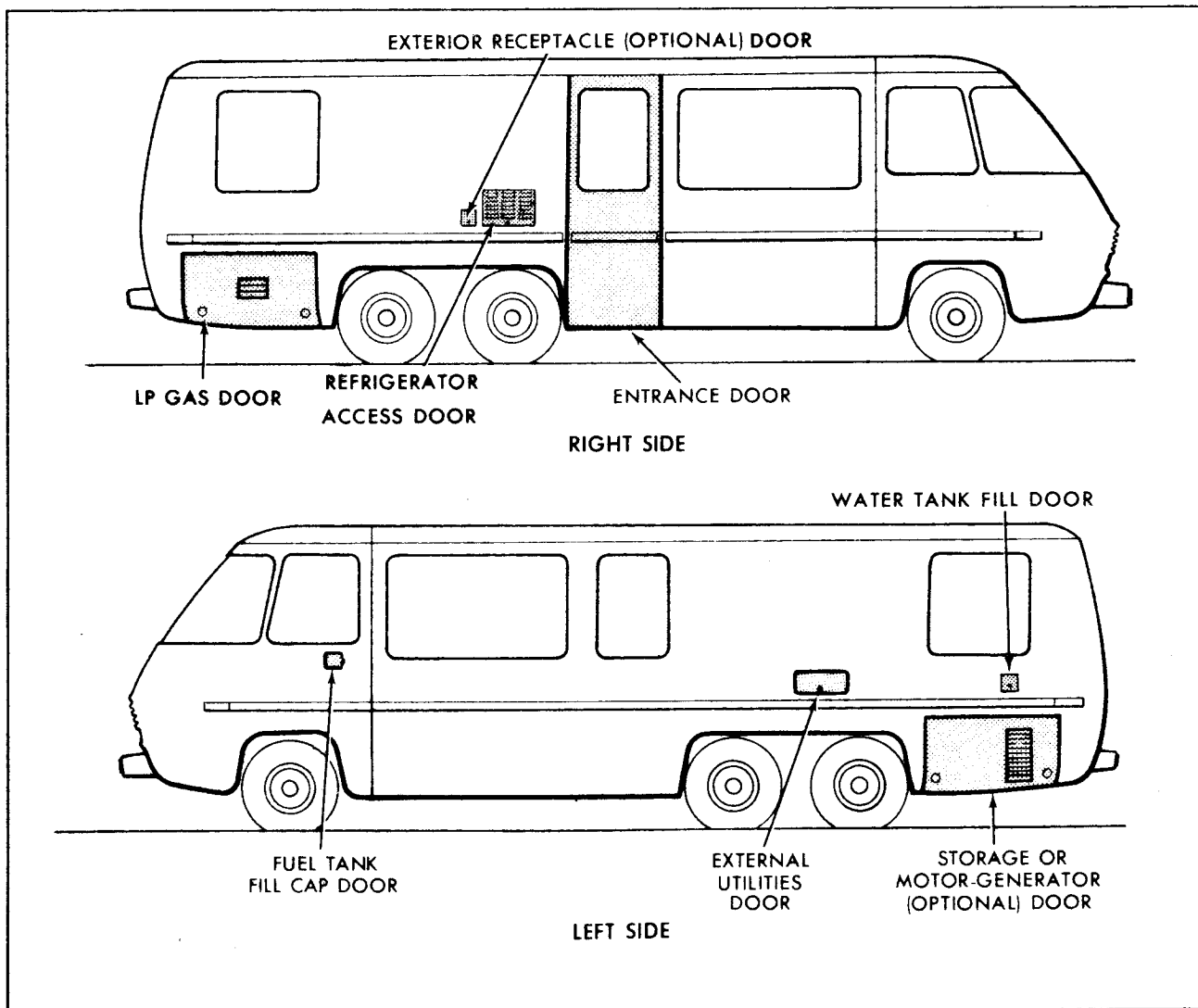

Exterior Compartment Location (Typical)

whether metric or customary. (Numbers on the heads of metric bolts and on surfaces of metric nuts indicate their strength. Customary bolts use radial lines for this purpose, while most customary nuts do not have strength markings.) Mismatched or incorrect fasteners can result in vehicle damage or malfunction, or possibly personal injury. Therefore, fasteners removed from the vehicle should be saved for re-use in the same locations whenever possible. Where the fasteners are not satisfactory for re-use, care should be taken to select a replacement that matches the original. For information and assistance, see your GMC Motorhome dealer.

MAINTENANCE SCHEDULE

For owner convenience, a separate maintenance folder has been provided with your vehicle which contains a complete schedule and brief explanation of safety, emission control, lubrication and general maintenance it requires. The maintenance folder information is supplemented

by this section of the Operating Manual, as well as a Warranty Information folder also furnished with vehicle. Read all three publications for a full understanding of vehicle maintenance requirements.

ACCESSIBILITY



Front Access Doors

EXTERIOR COMPARTMENTS

Your vehicle has an entrance door on the right side and seven compartment doors. Their locations are shown on the following illustrations.

Be sure the doors are secured tightly to prevent their opening after vehicle is in motion.

There are two front access doors on your vehicle. Turn the latch knob to the left to release each door. Items that can be checked or filled through the right access door are the main (automotive) battery, engine oil fill, radiator, radiator cap, coolant recovery tank and the air

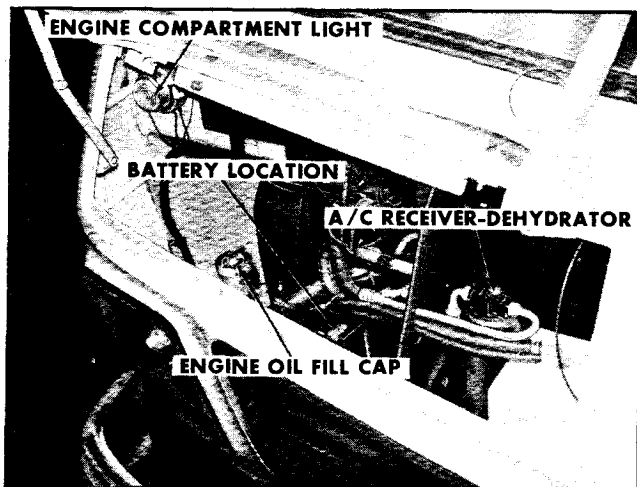

Right Front Access Compartment

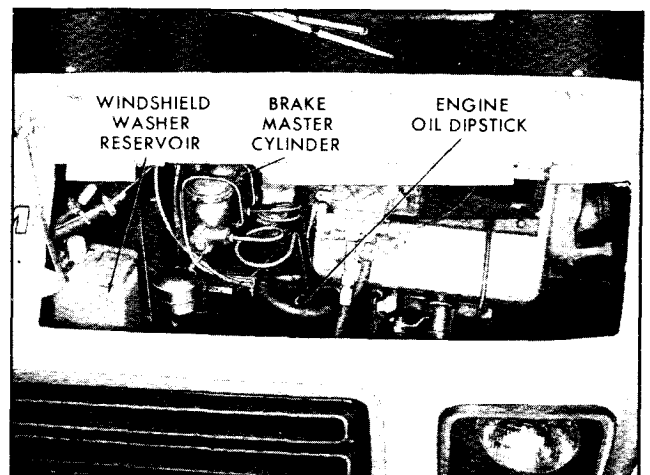

Left Front Access Compartment

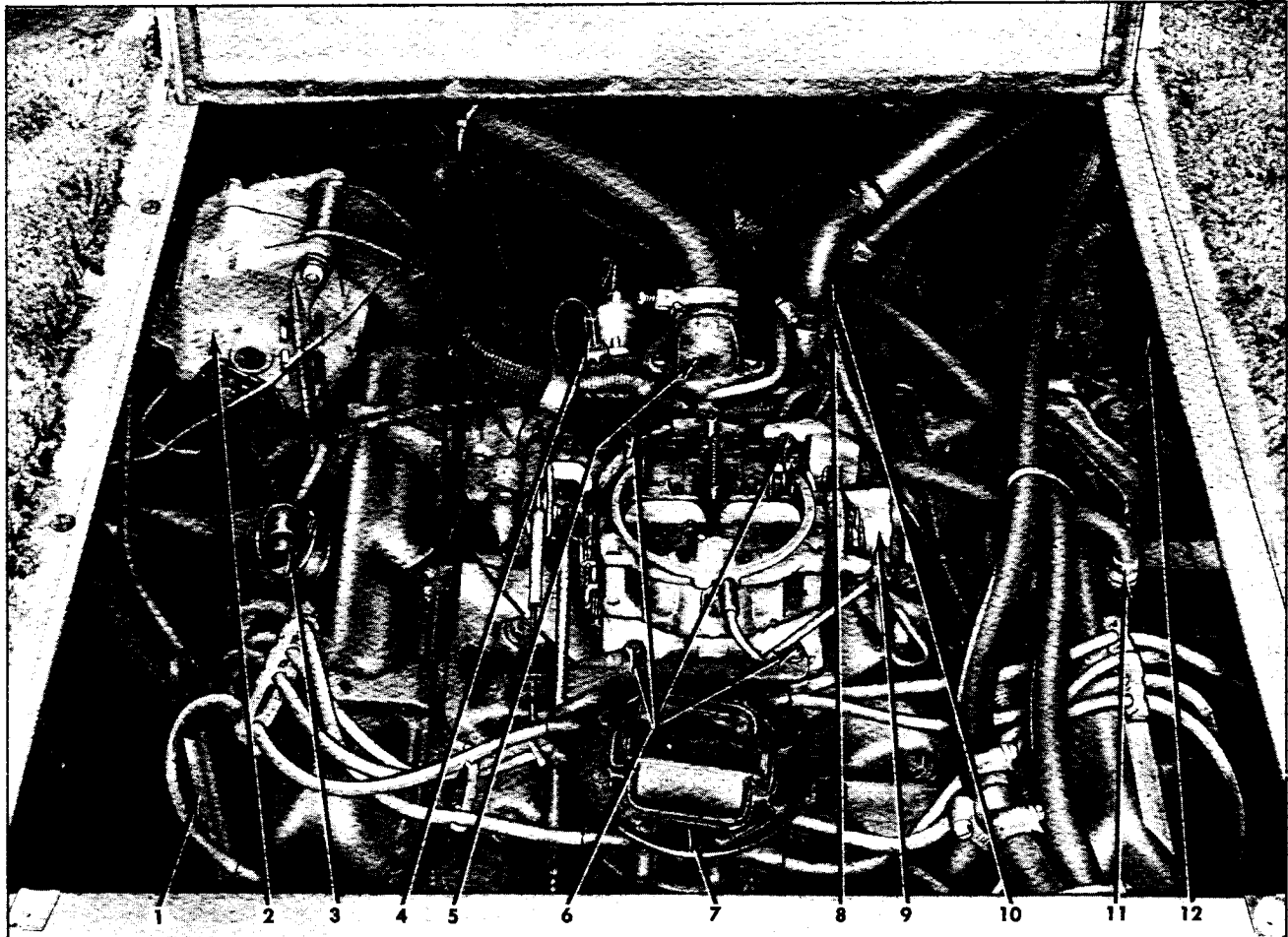

1. Automatic Transmission Fluid Dipstick and Fill Tube
2. Generator
3. PCV Filter
4. Engine Temperature Sending Unit
5. Thermostat Housing
6. Carburetor Attaching Bolts (4)

7. Distributor
8. Thermal Vacuum Switch
9. Carburetor Choke Coil Cover
10. Engine Oil Fill Hose and Tube Assembly
11. PCV Valve
12. Air Conditioning Compressor (Optional)

Engine Compartment

conditioner receiver-dehydrator sight glass (optional). Items that can be checked or filled through the left access door are the windshield washer reservoir, brake master cylinder, engine oil dipstick and the air compressor.

Be sure to secure the access doors after closing them by turning the latch knob to the right to prevent the doors from opening after the vehicle is in motion.

CAUTION

Before pouring fluid into any filler opening anywhere on the vehicle, or allowing anyone else to do so, make certain that the correct filler opening, and type of fluid has been selected. A wrong choice could result in serious personal injury or property damage.

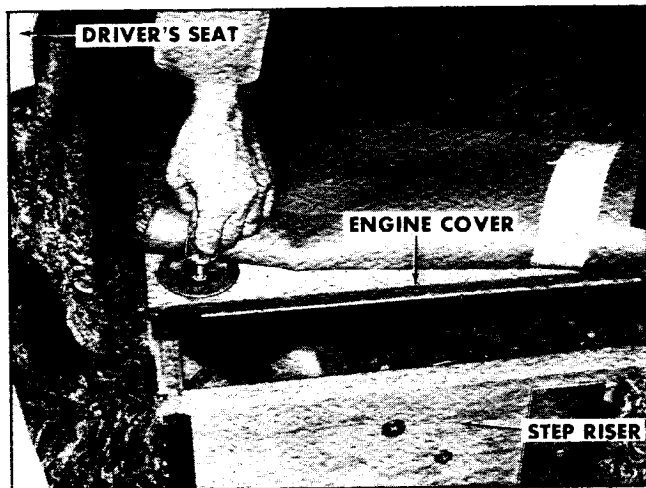

Removing Engine Access Cover

ENGINE ACCESSIBILITY

Access to the engine is provided by an engine cover located between the driver and passenger seats. The cover is designed to be secured at the two rear corners by securing bolts. The securing bolts have rings and may be loosened or tightened by hand or screwdriver. The cover is designed to be secured at the front by a retaining lip.

To remove the engine cover loosen the securing bolts and lift up using the wire loops. To

install the engine cover place the cover in its frame and slide forward as far as possible. Tighten the securing bolts.

CAUTION

It is essential that when installing the engine cover it be fully seated to its seal and secured by the lip at its forward edge and the securing bolts at its rearward edge. Do NOT allow cables, carpeting, floor mats or any other material to interrupt the seal between the cover and the engine compartment. If the engine cover is not correctly installed and seated, engine exhaust could leak into the passenger compartment creating a safety hazard (see the carbon monoxide caution at the beginning of the section on STARTING AND OPERATING VEHICLE). If the engine must run with the cover off for maintenance purposes, care should be taken to assure that the vehicle's interior is well ventilated.

ENGINE COMPARTMENT LIGHT

The optional engine compartment light (located behind right front access door) is turned ON when access door is opened. The light, attached to a 25-foot cord, may be removed from engine compartment for use as necessary.

HOISTING INSTRUCTIONS

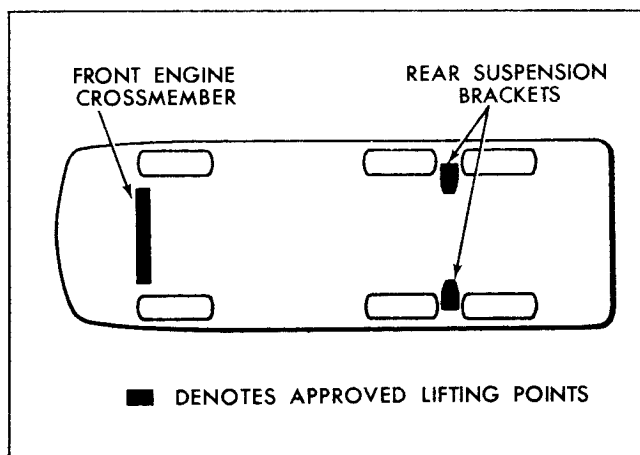

Vehicle Hoisting Points

A twin post hoist of sufficient capacity and with proper adapters and/or fittings must be used.

Front hoisting position is the front engine crossmember.

Rear hoisting must be done at the rear suspension brackets. If an "I" beam type adapter is used it should be approximately 82 inches in length to gain adequate support at suspension brackets.

If vehicle is to be placed on safety stands for maintenance or repairs, the hoisting points should be used.

CAUTION

To help avoid serious damage to your vehicle, the vehicle should be raised only on twin post hoists of 15,000 pounds or more total rated capacity, at

the suspension points noted (see diagram). Before raising, check overhead clearance to see that it is sufficient for the vehicle. Do NOT use the vehicle jack for hoisting or maintenance. It is designed for use only when changing tires.

LUBRICATION DETAILS

ENGINE

ENGINE OIL AND FILTER RECOMMENDATIONS

- Use only SE engine oil.
- Refer to Maintenance Schedule folder for oil change and filter replacement intervals.
- Operation in a dust storm may require an immediate oil change.
- AC oil filters provide excellent engine protection.
- See your GMC Motorhome dealer for advice on the frequency of oil and filter changes under unusual driving conditions.

The recommendations in the Maintenance Schedule folder apply to the first change as well as subsequent oil changes. The oil change interval for your vehicle's engine is based on the use of SE oils and quality oil filters. Oil change intervals longer than those listed will seriously reduce engine life and may effect GMC Truck & Coach's obligation under the provisions of the New Vehicle Warranty.

A high quality SE oil was installed in your engine at the factory. It is not necessary to change this factory-installed oil prior to the recommended normal change period. However, check the oil level more frequently during the break-in period since higher oil consumption is normal until the piston rings become seated.

NOTE: Non-detergent and other low quality oils are specifically not recommended. Only the use of SE engine oils and proper oil and filter change intervals assure you of continued proper lubrication of your vehicle's engine.

RECOMMENDED SAE VISCOSITY

- Single grade oils are preferred, however, multigrades such as SAE 10W-30 or 10W-40 are also acceptable.

- SAE 5W-20 oils are not recommended for sustained high speed driving.
- SAE 5W-30 oils (if available) may be used if extreme low temperatures are anticipated.

SUPPLEMENTAL ENGINE OIL ADDITIVES

The regular use of supplemental additives is specifically not recommended and will increase operating costs. However, supplemental additives are available that can effectively and economically solve certain specific problems without causing other difficulties. For example, if higher detergency is required to reduce varnish and sludge deposits resulting from some unusual operational difficulty, a thoroughly tested and

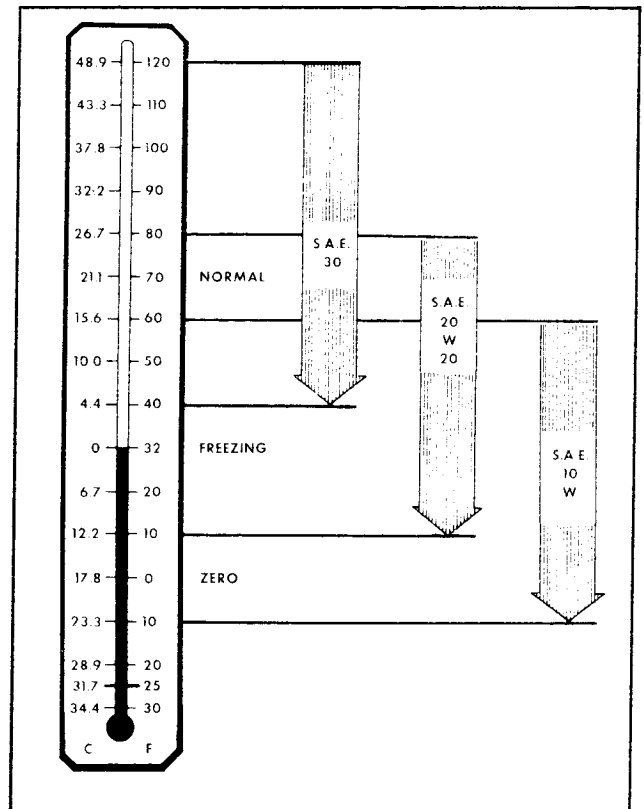

Engine Oil Viscosity Chart

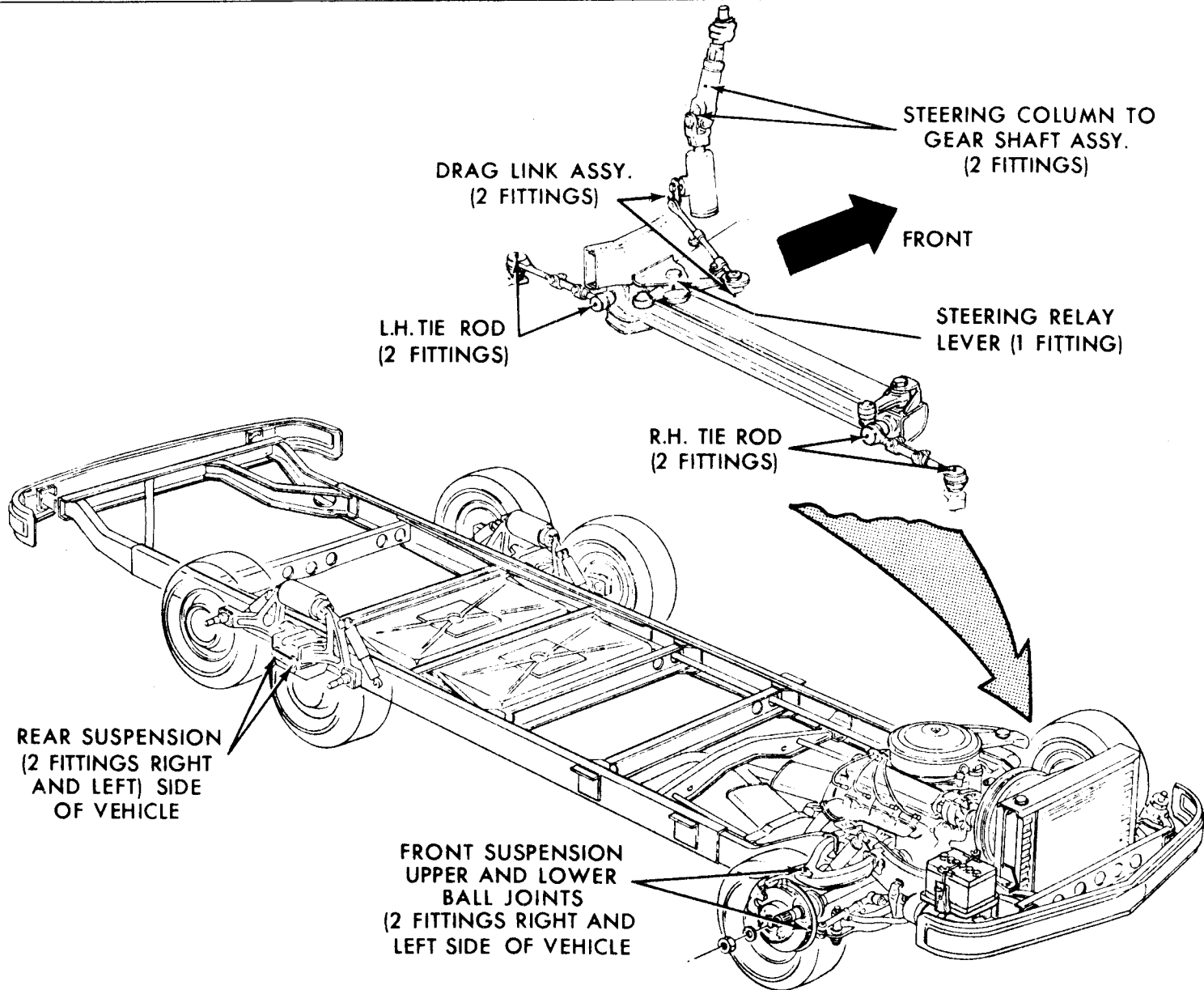

Location of Chassis Lubrication Fittings

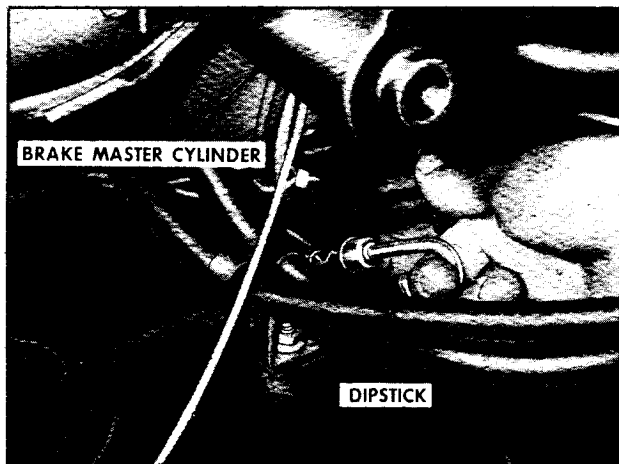

Removing Engine Oil Dipstick

approved additive—"GM Super Engine Oil Supplement"—is available at your GMC Motorhome dealer. In the event of an operational problem, consult your dealer for advice before using supplemental additives.

CHECKING OIL LEVEL

The engine oil should be maintained at the proper level. The best time to check it is before operating the engine or as the last step in a fuel stop. This will allow the normal oil accumulation in the engine to drain back into the crankcase. To check the level, remove the oil level dipstick located inside the left front access door, wipe it clean and reinsert it fully for accurate reading. The oil level dipstick is marked "FULL" and "ADD." The oil level should be maintained within the margin, neither going above the "FULL" line nor below the "ADD" line. Reseat the dipstick firmly after taking the reading. One (1) quart will raise the oil level from "ADD" to "FULL."

NOTE: The oil dipstick is also marked "USE SE ENGINE OIL," as a reminder to use only SE oils.

AUTOMATIC TRANSMISSION FLUID RECOMMENDATIONS

The transmission dipstick and fill tube is located under the engine access cover on the left side of the engine.

Use only automatic transmission fluids identified with the mark DEXRON® II. These fluids have been specially formulated and tested for use in your automatic transmission, and are

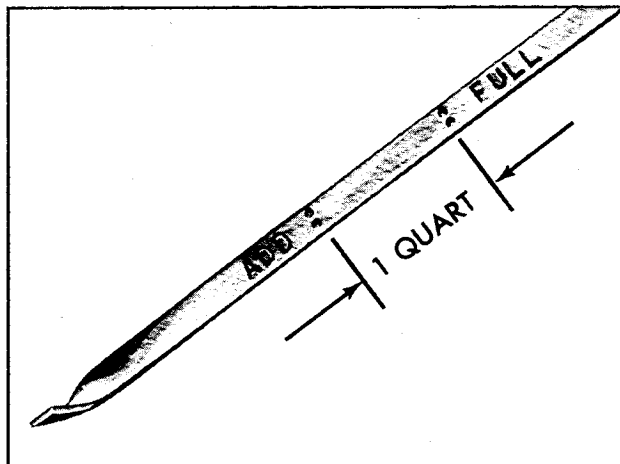

Engine Oil Dipstick

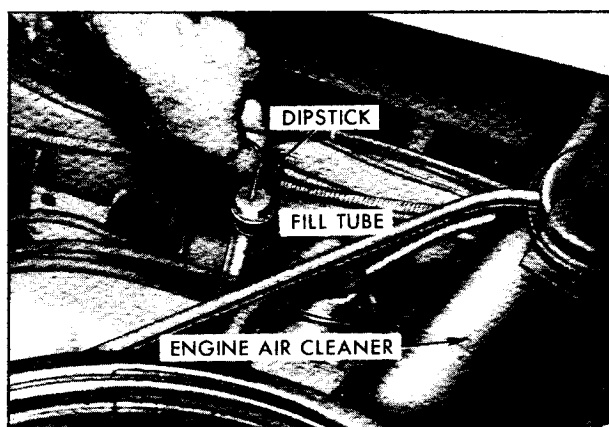

Removing Transmission Dipstick

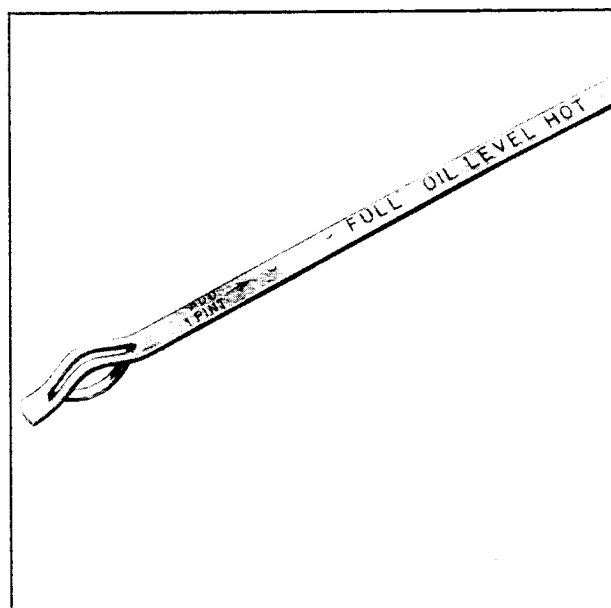

Transmission Dipstick

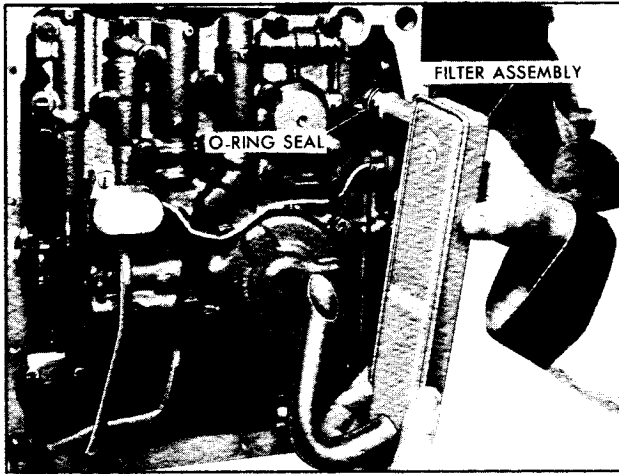

Replacing Transmission Oil Filter

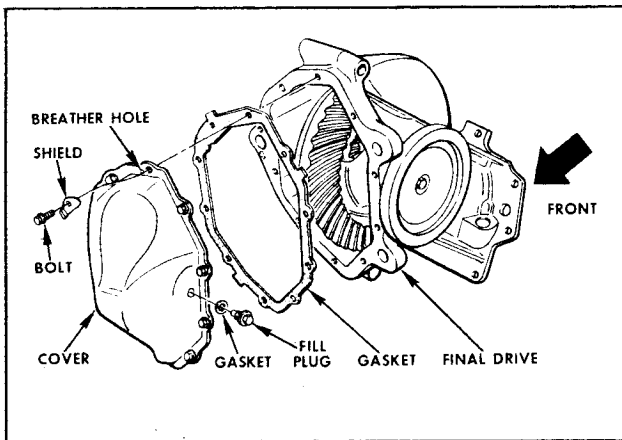

Final Drive Cover Removal

available from your GMC Motorhome dealer or local service station.

Automatic transmissions are frequently overfilled because the fluid level is checked when the fluid is cold and the dipstick indicates fluid should be added. However, the low reading is normal since the level will rise as the fluid temperature increases. A level change of over $\frac{3}{4}$ inch will occur as fluid temperature rises from 60°F. to 180°F. (16°C. to 82°C.).

Overfilling can cause foaming and loss of fluid through the vent. Slippage and transmission failure can result.

Fluid level too low can cause slipping, particularly, when the transmission is cold or the car is on a hill.

NOTE: If the vehicle has recently been operated for an extended period at high speed or in city traffic in hot weather or the vehicle is being used to pull a trailer, an accurate fluid level can-

not be determined until the fluid has cooled down—usually about 30 minutes after the vehicle has been parked.)

Check the fluid level at each engine oil change period.

1. Drive vehicle several miles, making frequent starts and stops, to bring transmission up to normal operating temperature (approx. 190-200° F.) (88-93° C.).
2. Park vehicle on a level surface.
3. Apply parking brake.
4. Place selector lever in "PARK" and leave engine running.
5. Open all but the two rear windows, then remove engine cover.
6. Remove dipstick and wipe clean.
7. Reinsert dipstick until cap seats.
8. Remove dipstick and note reading.

If fluid level is at or below the "ADD" mark, add sufficient fluid to raise the level to the "FULL" mark. One pint raises the level from "ADD" to "FULL." Do not overfill. Refer to the Maintenance Schedule folder for servicing interval.

TRANSMISSION OIL AND FILTER REPLACEMENT

NOTE: Have a drain pan ready as lubricant will begin to drain as bolts are loosened.

1. Remove (13) bottom pan attaching screws.
2. Remove bottom pan and discard gasket.
3. Remove and discard oil filter assembly.
4. Install new O-ring seal on new filter and intake pipe and filter assembly and install.
5. Using a new pan gasket, install pan. Torque attaching screws to 12 foot-pounds.
6. Add four (4) quarts of DEXRON® II automatic transmission fluid and check fluid as noted above.

FINAL DRIVE

FINAL DRIVE LUBRICANT REPLACEMENT

1. Remove (10) cover attaching bolts. Have a drain pan ready as lubricant will begin to drain as bolts are loosened.

2. Remove cover and allow lubricant to drain. Discard old gasket.

3. Using a new cover gasket, install cover. Torque attaching bolts to 24 foot-pounds. Shield to be bent over breather hole.

4. Add four pints of recommended lubricant through fill plug hole or fill until lubricant level is at the plug hole. Install fill plug.

NOTE: Use SAE 80W or SAE 80W-90 GL-5 Gear Lubricant. (For those vehicles operated in Canada, use SAE 80W GL-5 Gear Lubricant.)

STEERING SYSTEM

POWER STEERING SYSTEM

Check the fluid level in the power steering pump reservoir at each oil change period. This requires the removal of the engine access cover. The reservoir is located near the Delcotron. Add GM Power Steering Fluid (GM Part No. 1050017 or equivalent) as necessary to bring level into proper range on the filler cap indicator depending on fluid temperature.

If at operating temperature [approx. 150° F. (66° C.)—hot to the touch] fluid should be between "HOT" and "COLD" marks. If at room temperature [approx. 70° F. (21° C.)] fluid should be between "ADD" and "COLD" marks. The fluid does not require periodic changing.

STEERING LINKAGE

The steering linkage (tie rods) and suspension should be lubricated, using a Lithium Soap Multi-purpose grease that meets GM Specification 6031-M, at every oil change. Seals should be checked for damage (see Maintenance Schedule folder).

BRAKE SYSTEM

BRAKE MASTER CYLINDER

The master cylinder is located behind the left-side access door on the front of the vehicle. The fluid level in the master cylinder should be checked at each oil change. Wipe off the brake cylinder filler cap and unsnap the retainer. A low fluid level in the front brake master cylinder reservoir could be an indicator that the disc

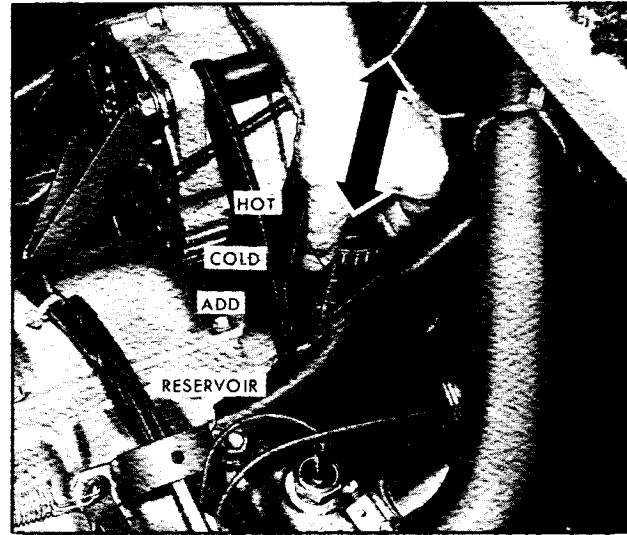

Checking Power Steering Fluid Level

brake pads need replacing. The fluid level must be maintained at ¼-inch below the top of each reservoir with Delco Supreme No. 11 or DOT-3 Brake Fluid or equivalent. When replacing the cap be sure to fasten the retainer securely, taking care not to let dirt enter the reservoirs.

BLEEDING BRAKES

The need for bleeding brakes is generally indicated by springy, spongy pedal action. Pressure bleeding equipment must be used and a definite bleeding sequence and procedure must be followed. Consult your GMC Motorhome dealer.



Checking Brake Master Cylinder

SERVICING DETAILS

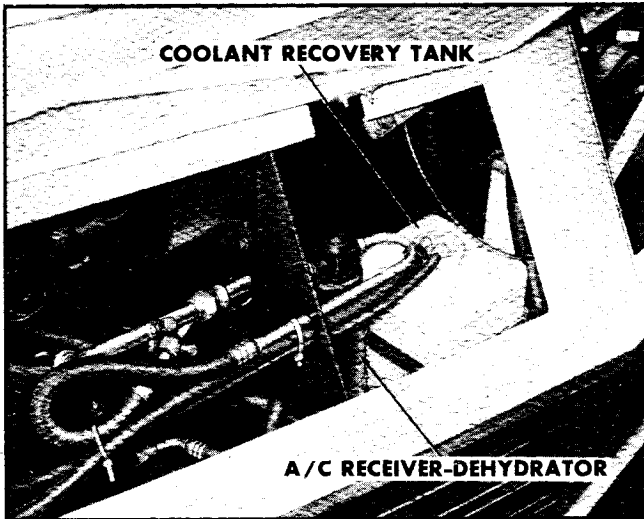

Coolant Recovery Tank (Typical)

ENGINE COOLING SYSTEM

The recovery type cooling system is standard on all vehicles covered by this manual. The coolant expands with rising temperature and the overflow is collected in the recovery tank. When the system temperature drops, the coolant is drawn back into the radiator. The cooling system has been filled at the factory with a high-quality, inhibited, year-around coolant that meets the standards of General Motors Specification 1899-M. This coolant solution provides freezing protection to -20°F. (-29°C.) [-35°F. (-37°C.) in Canada], and it was formulated to be used without replacement for



Location of Radiator Cap

period specified in Maintenance Schedule folder, providing the proper concentration of coolant is maintained.

COOLING SYSTEM CARE

Checking Coolant Level

Open right front access cover. Do not remove radiator cap to check coolant level, but check visually in the "see thru" coolant recovery tank as frequently as necessary. Level should be at the "COLD" mark on the recovery tank when the system is cold; and at the "HOT" mark at normal operating temperature. Add a 50/50 mixture of high-quality ethylene glycol antifreeze and water to the recovery tank for coolant additions. If frequent additions are required, see your dealer for a cooling system check.

NOTE: If recommended quality antifreeze is used, supplemental inhibitors or additives claiming to provide increased cooling capability are not necessary. They may be detrimental to the efficient operation of the system, and represent an unnecessary operating expense.

Annual Service

The cooling system should be checked each year as follows:

1. Wash radiator cap and filler neck with clean water.
2. Check coolant for proper level and freeze protection.

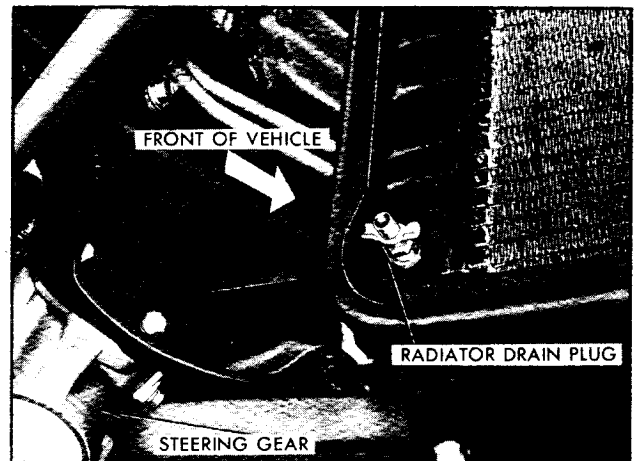

Radiator Drain Plug

3. Test system and radiator cap for proper pressure holding capacity (9 psi). If required, use cap designed by AC for coolant recovery systems and specified for your vehicle.

4. Tighten hose clamps and inspect all hoses. Replace hoses every 24 months, earlier if swollen, checked or otherwise deteriorated.

5. Clean frontal area of radiator core and air conditioning condenser.

Draining and Refilling

The cooling system should be drained, flushed and refilled using the following recommended procedure at intervals specified in the Maintenance Schedule folder.

1. Remove radiator cap when engine is cool:

- Rotate cap slowly counterclockwise to detent (Do not press down while rotating).
- Wait until residual pressure (indicated by a hissing sound) is relieved, then press down on cap and continue to rotate counterclockwise.

CAUTION

To help avoid the danger of being burned, do not remove radiator cap while engine and radiator are still hot because cooling system will blow out scalding fluid and steam under pressure.

2. Run engine, with radiator cap removed, until upper radiator hose is hot (indicates thermostat is open).

3. Stop engine and open radiator drain valve to drain coolant. (Operation may be speeded by removing drain plugs in the block.)

4. Close valve (install block drain plugs, if removed) and add sufficient water to fill system.

5. Repeat steps 1, 2, 3, and 4 a sufficient number of times until the drained liquid is nearly colorless.

6. Allow system to drain completely and then close radiator drain valve tightly. (Install block drain plugs, if removed.)

7. Remove recovery cap leaving hoses in place. Remove coolant recovery tank, empty fluid, scrub and clean bottom and sides of tank

with detergent and water, flush well with clean water, drain and reinstall.

8. Add sufficient ethylene glycol coolant, meeting GM specification 1899-M, to provide the required freezing and corrosion protection — at least a 50 percent solution (-34° F.) (-37° C.). Fill radiator to the base of the radiator filler neck and bring level of coolant in the recovery tank to the "HOT" mark. Reinstall recovery tank cap.

9. Run engine, with radiator cap removed, until radiator upper hose becomes hot.

10. With engine idling, add coolant to radiator until level reaches bottom of filler neck; install cap making certain arrows line up with overflow tube.

11. Add sufficient coolant to coolant reservoir to raise level to the "HOT" mark. Install reservoir cap.

IMPORTANT: If Motorhome is equipped with water heater pre-heat, coolant level in coolant reservoir must be checked and coolant added, as necessary, after several hours of operation. The additional length of heater hose used in this system requires a longer period to normalize the coolant level.

Owner Responsibility

It is the owner's responsibility to:

- Maintain cooling system freeze protection at -20° F. (-29° C.) or below to ensure protection against corrosion and loss of coolant from boiling, even though freezing temperatures are not expected.
- Add ethylene glycol base coolant that meets GM Specification 1899-M when coolant additions are required because of coolant loss or to provide additional protection against freezing at temperatures lower than -20° F. (-29° C.) [-35° F. (-37° C.) in Canada].

NOTE: Alcohol or methanol base coolants or plain water are not recommended for your vehicle at any time.

"ENGINE WATER" LIGHT IS ON

If the cooling system "ENGINE WATER" light is illuminated this is an indication that the coolant level in the radiator is abnormally low and requires immediate service. Be sure to heed the CAUTION on preceding page.

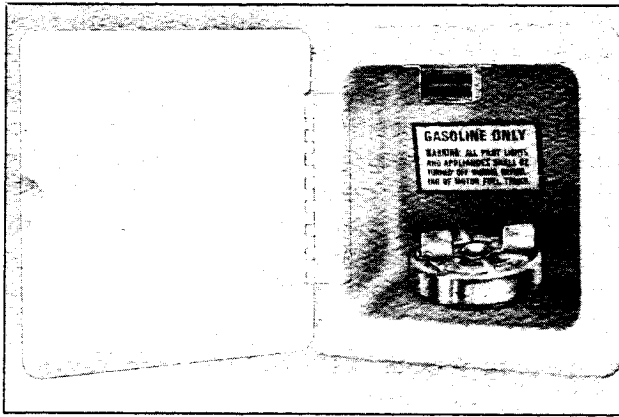

Gasoline Fuel Filler Compartment

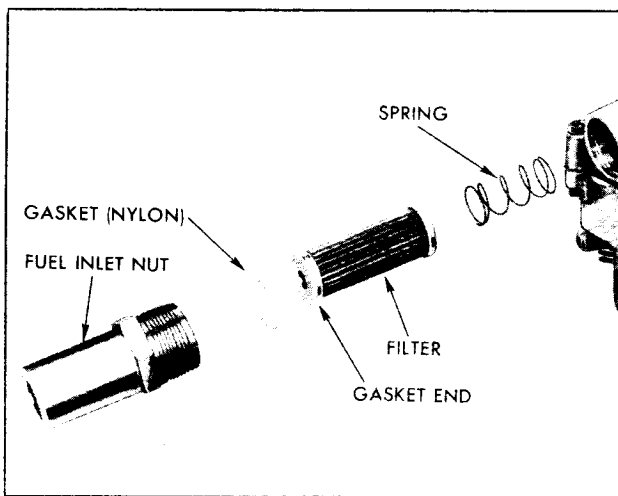

Fuel Filter Components



Removing Engine Air Cleaner Element

1. Allow engine to cool. While engine is cooling, visually inspect radiator, engine, all cooling system hoses for source of low coolant level, and correct problem if possible.

2. If leakage problem cannot be readily corrected, do not run engine until vehicle is repaired and refilled by a qualified mechanic.

3. Refill cooling system by performing Steps 8-11 of "Draining and Refilling".

THERMOSTAT

The cooling system is protected and controlled by a thermostat installed in the engine coolant outlet to maintain a satisfactory operating temperature of the engine. This thermostat is designed for continuous use through both winter and summer and need not be changed seasonally. When replacement is necessary, Delco parts are recommended.

ENGINE FUEL SYSTEM

FUEL REQUIREMENTS

Your vehicle's engine is designed to operate on unleaded gasoline which minimizes spark plug fouling and emission control system deterioration. Regular grade leaded gasoline may be used under normal operating conditions and also to eliminate knock. Knock is a metallic rapping noise generated during the combustion process. If knocking persists, consult your authorized dealer. Continuous or excessive knocking may result in engine damage and constitutes misuse of the engine for which GMC Truck and Coach Division is not responsible under the terms of the New Vehicle Warranty. The engine does not require Premium grade fuel. Therefore, its use would be an unnecessary additional expense.

If an unleaded gasoline is used it must meet the *minimum* octane specifications established by the Federal government. In compliance with Federal regulations, pumps dispensing such gasoline are labeled with the word UNLEADED.

FUEL SYSTEM

The vehicle has two gasoline tanks of approximately 25 gallons each and a fuel switching device (see "FUEL SELECTOR" switch)

which allows the driver to switch from the main tank (when empty) to the auxiliary tank.

The gasoline fuel filler compartment is located on the left side of the vehicle, directly under the driver's window.

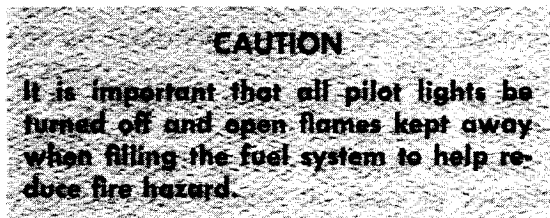

GAS CAP—The cap is equipped with a double set of locking tangs.

To Remove:

- Rotate cap one-half turn counterclockwise to clear the first set of tangs from the slots inside the filler neck. This will allow any residual pressure to escape.
- Pull the cap outward and rotate one-quarter turn counterclockwise to clear second set of tangs. Then remove the cap.
- To install, reverse this procedure.

NOTE: If the gas cap requires a replacement, only a cap with the same features should be used. Failure to use the correct cap can result in a serious malfunction of the fuel system. Correct replacement caps may be obtained from your GMC Motorhome dealer.

IMPORTANT: If automatic gasoline pump nozzle shuts off before both fuel tanks are full, it is recommended that a delay of approximately one minute be held prior to continuation of filling tanks. Automatic nozzle should then be adjusted for a slower fuel feed, to fill remainder of tanks.

CARBURETOR

To obtain maximum engine performance and fuel economy, carburetor idle speeds should be checked as recommended in the Maintenance Schedule folder. If the engine stalls, idles too fast or slow, or idles roughly, the following adjustments should be performed. However, if the above symptoms persist it is recommended the vehicle be taken to a GMC Motorhome dealer.

NOTE: Refer to Tune-up label on engine for correct specifications.

Fuel Filter

To replace carburetor filter, disconnect fuel line, remove filter nut, gasket, filter, and spring. Install spring and element (open end of filter facing toward filter nut). Install gasket; tighten nut to 18 foot-pounds torque.

IMPORTANT: Tightening fuel inlet nut beyond specified torque can damage nylon gasket.

ENGINE AIR CLEANER

The air cleaner is a disposable type element. Replace the element as specified in the Maintenance Schedule folder. Do not wash, oil, or clean with air hose. The air cleaner will require more frequent service under dusty conditions. Your GMC Motorhome dealer can advise you on the proper interval. When replacement is necessary, an AC ACron air filter element is recommended.

NOTICE

DO NOT remove the engine air cleaner unless temporary removal is necessary during repair or maintenance of the vehicle. When the air cleaner is removed backfiring can cause fire in the engine compartment.

CHASSIS ELECTRICAL SYSTEM

BATTERIES

There are two Delco Batteries used in the chassis and living area of the Motorhome. The main battery (or automotive battery) is located behind the right front access door. The auxiliary battery (living area battery) is located in the storage or motor generator compartment.

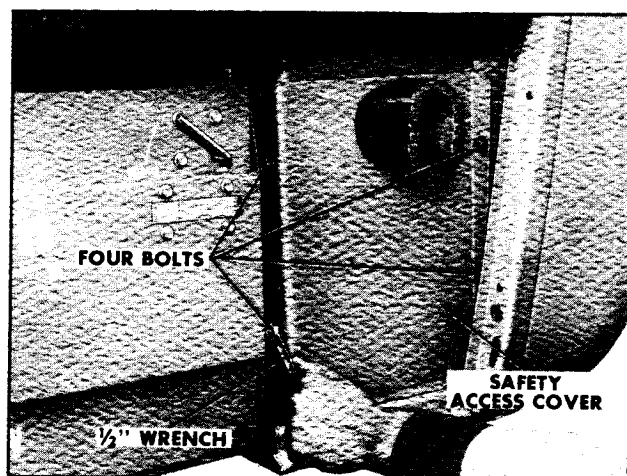

Removing Safety Access Cover

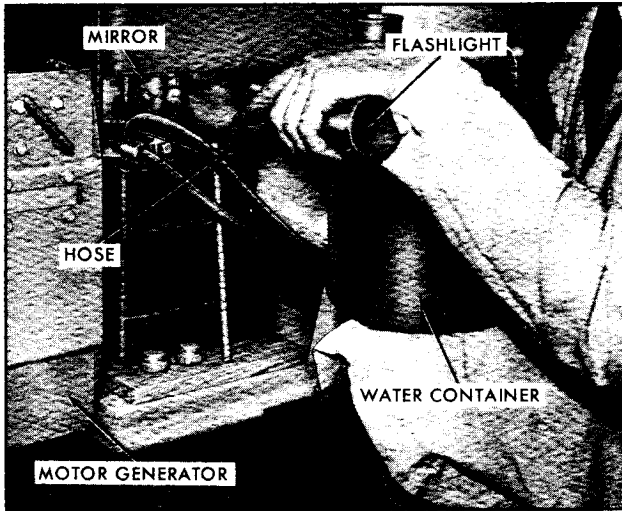

Checking and Adding Water to Living Area Battery

It is important that these batteries receive the following care:

1. If the battery has flame arrestor type filler vent caps, check the fluid level in each cell at each engine oil change interval and more often in hot weather. (To do this it may be helpful to use a small hand mirror.) Add only colorless, odorless drinking water or distilled water to bring the level to the split-ring in the filler opening. **DO NOT OVERFILL.**

To service auxiliary (living area) battery located in motor generator or storage compart-

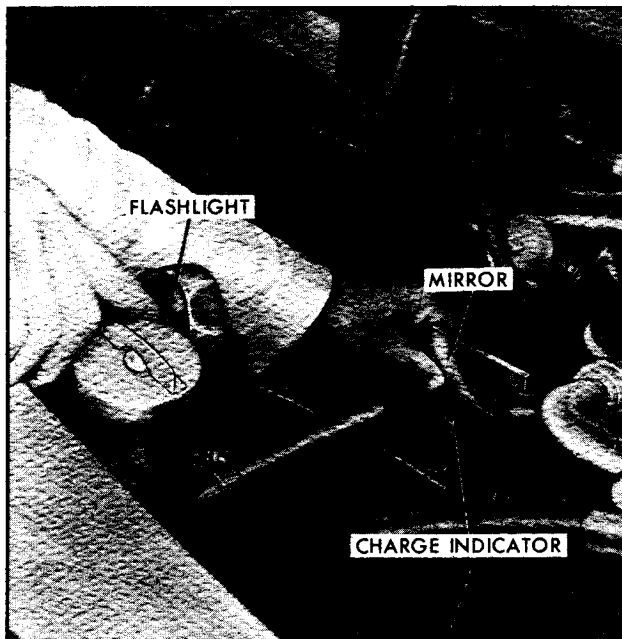

Checking Maintenance-Free Battery

ment, use a 1/2-inch wrench or socket to remove four bolts from safety access cover. Remove cover. Position flashlight, mirror, water container, and hose as shown. Check fluid level and add water as required.

2. The main (automotive) battery may be a maintenance-free battery identified by the absence of vent caps. Water never needs to be added to the maintenance-free battery. A charge indicator located on the top of the battery indicates the state of charge. Check the charge indicator at each oil change interval (a small hand mirror may be helpful in reading the indicator).

- If the charge indicator is dark and has a green dot in the center, the battery is sufficiently charged.
- If the charge indicator is dark and a green dot is not visible, have the battery charged at your dealer.
- If the battery indicator has a light or bright center, the battery must be replaced. If the battery fails prematurely and exhibits a light indicator condition, have your dealer check the charging system of the vehicle.

CAUTION

To avoid explosion hazard, NEVER attempt to charge or jump start a maintenance-free battery which exhibits a light indicator condition. Departures from this procedure could result in serious personal injury or property damage. For additional details refer to "JUMP STARTING" earlier in this manual.

3. Keep your batteries, battery cable terminals, and battery hold-down brackets clean. They should be cleaned every 12,000 miles or once a year. Use a brush and a solution of ammonia and water or baking soda and water. Flush off with clear water. After cleaning apply petroleum jelly or petrolatum to battery cable terminals to help retard corrosion.

4. If battery performance becomes questionable see your dealer.

For full voltage requirements a Delco battery is recommended at replacement time.

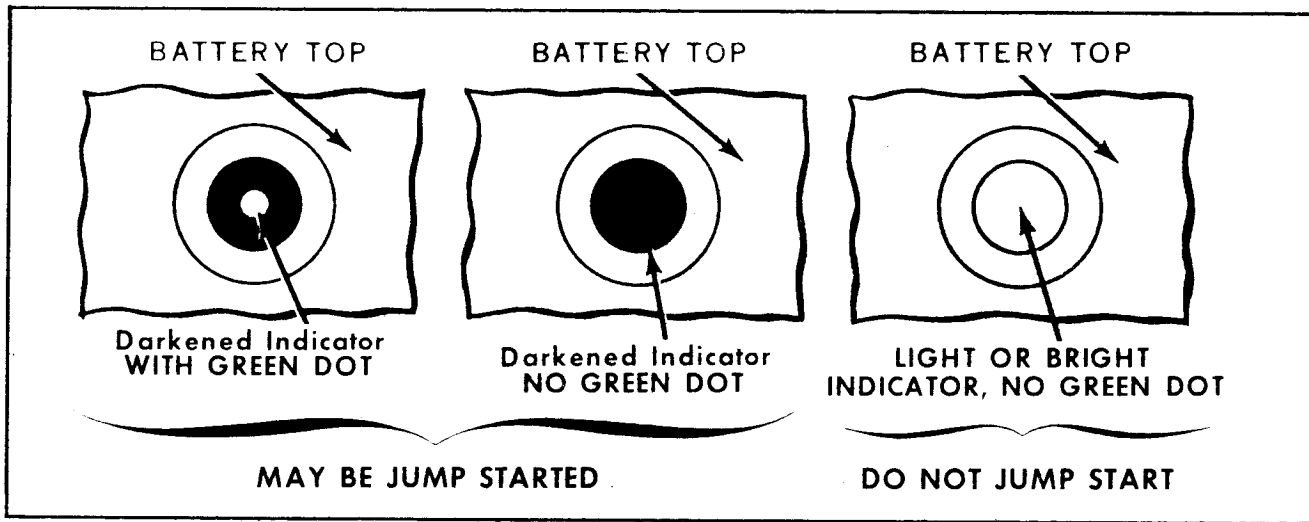

Charge or Test Indicator Conditions (Maintenance-Free Battery)

CAUTION

Never expose battery to open flame or electric spark—chemical action in the battery generates hydrogen gas which is flammable and explosive. Do not allow battery fluid to contact eyes, skin, fabrics, or painted surfaces—fluid is a corrosive sulfuric acid solution which could cause serious personal injury or property damage. **FLUSH ANY CONTACTED AREA WITH WATER IMMEDIATELY AND THOROUGHLY. WEAR EYE PROTECTION WHEN WORKING ON OR NEAR BATTERY.** Remove rings, metal watchbands and other metal jewelry before working on or around a battery. Be careful in using metal tools and equipment. If such metals should contact the positive battery terminal (or metal in contact with it) and any other metal on the vehicle, a short circuit may occur which could cause personal injury. Batteries should always be kept out of the reach of children.

NOTE: Refer to Tune-up label on engine for correct specifications.

SPARK PLUGS

The frequency of spark plug service intervals is explained in the Maintenance Schedule folder. Servicing is the owner's responsibility. Before removing plugs, clean plug wells thoroughly, clean the threads and seats in the cylinder heads to assure proper seating and heat transfer.

HEADLIGHTS

Make a headlight beam adjustment check a regular part of your "Safety Maintenance" program. Sealed-Beam units are No. 6014 which are equipped with ground guide points for the use of a mechanical aiming device. Your authorized dealer is best qualified to adjust your headlights.

For "Battery Jump Starting Procedure" see IN CASE OF EMERGENCY section.

DISTRIBUTOR

Distributor maintenance, which is the owner's responsibility, includes regular examination of the distributor cap for cracks, checking condition of ignition wires, and proper ignition timing at specified intervals. Refer to the Maintenance Schedule folder for additional information.

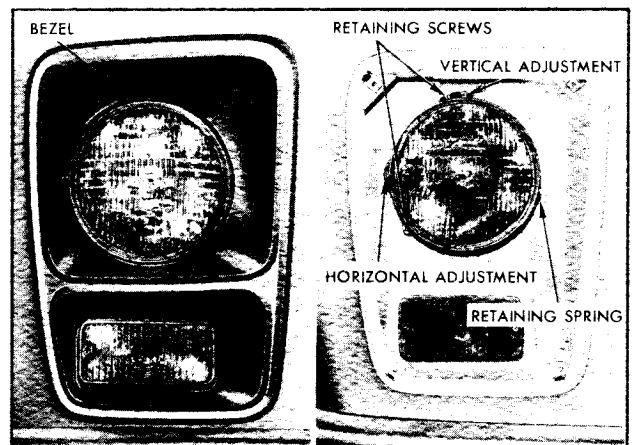

Headlight Replacement

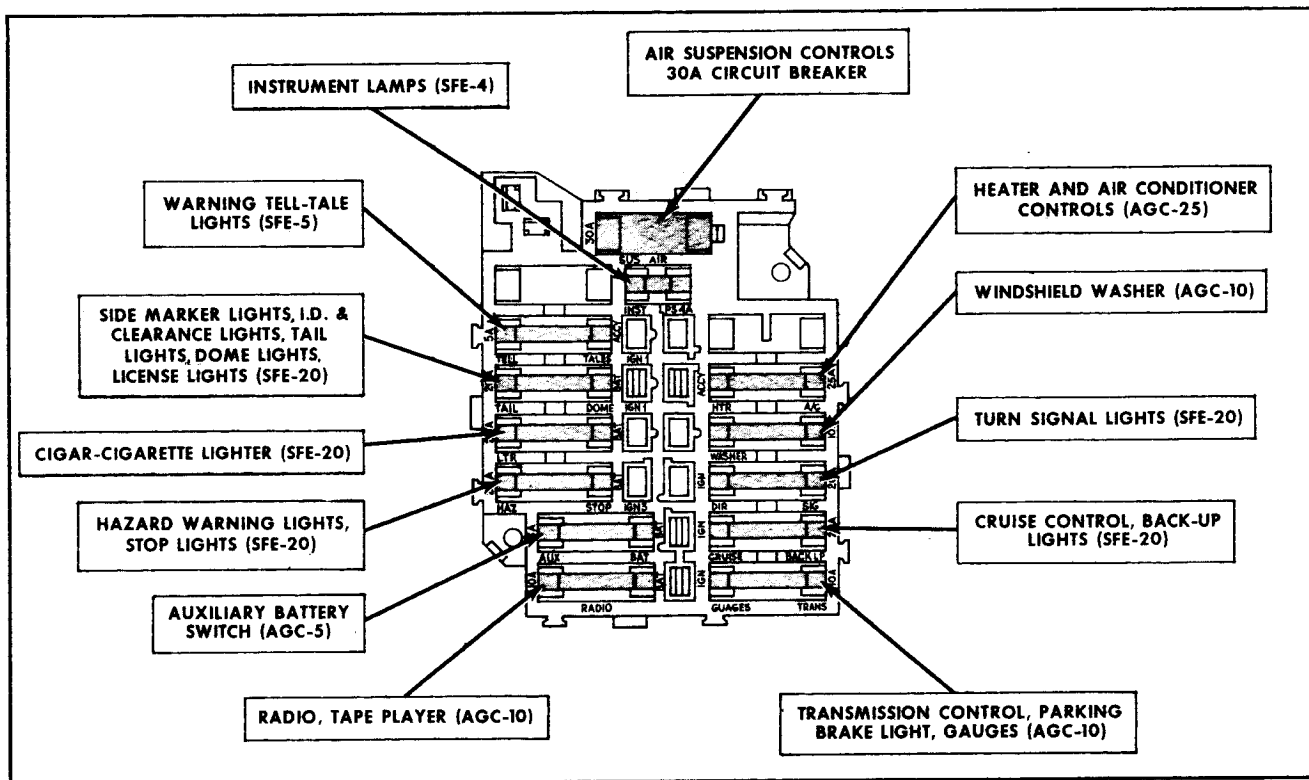

Chassis Fuse Block

Headlight Beam Adjustment

NOTE: Cutouts in headlight bezel permit access to adjustment screws.

Headlights should be adjusted properly. The top adjusting screw provides vertical adjustment and the side adjusting screw provides horizontal adjustment. Headlights should not have to be adjusted after replacing Sealed-Beam unit, providing headlights were in proper adjustment before replacement and adjusting screws were not disturbed during replacement.

Headlight Replacement

To replace a Sealed-Beam unit, remove bezel. Then disengage the tension spring using a stiff hooked tool. Rotate the Sealed-Beam assembly slightly to disengage mounting ring slots from groove of each adjusting screw, then pull forward. Disconnect wiring at the base of unit and separate the Sealed-Beam assembly by removing the two retaining screws. Install Sealed-Beam unit in reverse order of removal.

EXTERIOR LIGHTS

All exterior lights can be easily replaced by removing lens, pushing bulb in slightly and turn-

ing counterclockwise, except side marker lights which are simply pressed in. Then, with new bulb, reverse procedure.

CHASSIS FUSES, FUSIBLE LINKS, CIRCUIT BREAKERS

The wiring circuits in your vehicle are designed to be protected from short circuits by a combination of fuses, circuit breakers, and fusible thermal links in the wiring itself. This helps to reduce the hazard of electrically-caused fires in the vehicle.

The fuse and circuit breaker block is located behind the glove compartment. To gain access to the chassis fuse block, open the glove box door, then release the secondary cable latch in the back of the glove compartment. Glove box will now come forward, exposing fuse block. All chassis circuits are protected by fuses or circuit breakers located here except:

- **HEATER BLOWER**—Which has a fusible link built into harness located behind the right access door near the heater blower relay.
- **HEADLAMP CIRCUITS**—Are protected by a circuit breaker in the main light switch. An electrical overload in the light circuit will

cause the lights to go on and off or in some cases to remain off. If this condition develops, have the wiring circuits checked immediately.

Circuit breakers of remote reset type can be reset only after turning the affected circuit control switch "OFF" for approximately 40 seconds, or by removing the breaker from clips for this period of time.

CAUTION

Do not touch body of any installed breaker of this type with bare hands; if circuit should happen to be shorted or overloaded—the breaker body could be hot and cause a burn.

A replaceable fuse link is located at the battery pickup junction block behind the right access door. If an overload should occur, this link is designed to fail (open circuit) preventing damage to the main wiring harness. Another link of the same wire gauge and length must be installed in its place in the event of failures.

IMPORTANT: When replacing fuse or circuit breaker, make sure replacement is of same number as marked on block.

TURN SIGNAL AND HAZARD WARNING FLASHER

The turn signals and the hazard warning system both operate with the same flasher. This flasher is clipped behind the dashboard just to the right of the steering column.

WHEELS AND TIRES

Tires

The factory installed tires on your vehicle are designed to provide the best all-around performance for normal vehicle operation. When inflated as recommended on the "Tire Pressure Placard," located on the glove compartment door of your vehicle, the tires have the load carrying capacity to operate satisfactorily at all normal highway speeds.

This section contains some tips on how you can obtain maximum benefit from these tires and your investment in them.

Vehicle Loading

See Page 1 in this Manual for Important Information on Vehicle Loading.

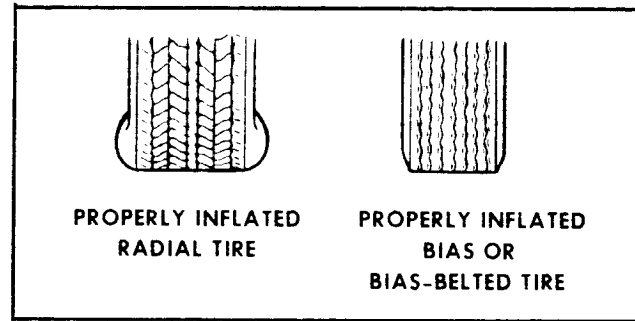

Tire Inflation

Inflation Pressure

The cold inflation pressures for your factory installed tires are listed on the "Tire Pressure Placard" located on the glove compartment door. Improper tire inflation pressures for the load you are carrying can adversely affect tire life and vehicle performance.

Too low an air pressure can result in tire overloading, abnormal tire wear, adverse vehicle handling, and reduced fuel economy. The tire flexes more and can build up excessive heat, weakening the tire and increasing susceptibility to damage or failure. Too high an air pressure can result in abnormal wear, harsh vehicle ride, and increased susceptibility to damage from road hazards.

Tire inflation pressures should be checked when the tires are "cold" at least monthly.

1. The "cold" tire inflation pressure rating applies to the tire pressure when the vehicle has not been driven for three hours or more, or driven less than one mile.

NOTE: The cold inflation pressures for your tires are:

- Bias-belted tires 60 psi
- Radial Tires 65 psi

2. It is normal for tire pressures to increase 4-8 psi or more, when the tires become "hot" from driving. **Do not** "bleed" or reduce tire inflation pressures after driving your vehicle. Bleeding serves to reduce "cold" inflation pressure and increase tire flexing which can result in tire damage and failure.
3. For sustained driving over 65 mph (105 Km/h) cold inflation pressures should be increased 10 psi above the recommended cold inflation pressures.

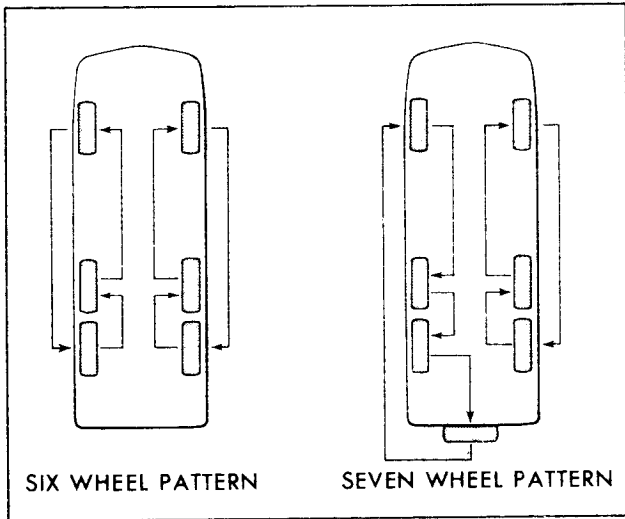

Tire Rotation Diagram

4. Always use a tire pressure gauge (a pocket type gauge is recommended) when checking inflation pressures. Radial tires may have the appearance of being under-inflated when at recommended cold inflation.
5. Be sure to re-install the tire inflation valve caps, if so equipped, to prevent dirt and moisture from entering the valve core which could cause air leakage.
6. If an air loss occurs while driving, do not attempt to drive on the deflated tire more than necessary to stop safely. Driving even a short distance on a deflated tire can damage a tire and wheel beyond repair.

Inspection and Rotation

Front and rear tires perform different jobs and can wear differently depending on the type of roads driven, individual driving habits, etc. To obtain maximum tire life you should inspect and rotate your tires regularly. Many GMC Motorhome dealers and tire dealers will perform a free tire inspection and assist you in identifying uneven or abnormal tire wear.

Tire Rotation

To equalize wear it is recommended that the tires be rotated every 6,000 miles (or sooner if irregular wear develops) as shown.

NOTE: It is recommended that disc brake pads be inspected for wear whenever tires are rotated.

Alignment and Balance

Proper front-end alignment and regular inspection of your front end suspension components will help to extend your tire life. See the Maintenance Schedule folder for more information. Improper toe alignment will cause your front tires to roll at an angle resulting in excessive wear. Improper caster or camber alignment will cause your front tires to wear more on one side than on the other and can cause the vehicle to "pull" to the left or right.

Proper tire balancing provides the best riding comfort and helps to minimize tire tread wear. Out-of-balance tires can cause annoying vehicle vibration and irregular tire wear such as cupping, flat spots, etc. Improper front wheel alignment will not cause vibration.

Tire Traction

A decrease in driving, cornering, and braking traction occurs when water, snow, ice, gravel, or other material is on the road surface. Driving practices and vehicle speed should be adjusted to the road conditions.

When driving on wet or slushy roads, it is possible for a wedge of water to build up between the tire and road surface. This phenomenon, known as hydroplaning, may cause partial or complete loss of traction, which adversely affects vehicle control and stopping ability. To reduce the possibility of traction loss, the following precautions should be observed:

1. Slow down during rain-storms or when roads are slushy.
2. Slow down if road has standing water or puddles.
3. Replace tires when tread wear indicators are visible.
4. Keep tires properly inflated.

Snow Tires

If the vehicle is expected to encounter muddy or snowy driving conditions it is recommended that front driving wheels be equipped with mud and snow type tires.

If you equip your vehicle with mud and snow tires, they should be of the same size, load range, and construction type (bias-belted or radial) as your other tires. It is recommended that vehicle speeds be limited to a maximum of 65 mph (105 km/h) if mud and snow tires are installed.

Tire Replacement Considerations

CAUTION

Do not mix different construction types of tires on your vehicle such as radial, bias, and bias-belted tires except in emergencies, because vehicle handling may be seriously affected.

You should replace your tires when ...

1. Your tires are worn to a point where 1/16 inch or less tread remains or the cord or fabric is exposed. To help you detect this condition, your tires incorporate built-in tread wear indicators which appear in the tread grooves when tread depth is 1/16 inch or less. When the indicators appear in two or more adjacent grooves at three locations around the tire, the tire should be replaced.
2. Your tire tread or sidewall is cracked, cut, or snagged deep enough to expose the cord or fabric.
3. Your tire has a visible bump, bulge, or separation.
4. Your tire sustains a puncture, cut, or other injury that cannot be satisfactorily repaired because of the size or location of the injury.

When replacing tires, you should use size 8.75-16.5LT or 8.75R-16.5LT, load range "D". Also, the construction type must be bias-ply steel belted, or steel belted radial.

Use of any other size or type tire may seriously affect load carrying capacity, ride, handling, speedometer/odometer calibration, vehicle ground clearance, and tire clearance to the body and chassis. If replacing only a single tire, it should be paired on the same axle with the least worn tire of the other five.

Wheel Replacement Considerations

Wheels must be replaced if bent, heavily rusted, leak air, or if lug nuts continually loosen. Do not straighten bent wheels or use inner tubes in leaking wheels used with tubeless tires.

When replacing wheels for any reason, the replacement wheels should be equivalent in load capacity, inflation pressure capacity, diameter, width, offset, and mounting configurations to those originally installed in your vehicle. Be sure the word "RADIAL" is stamped on the rim.

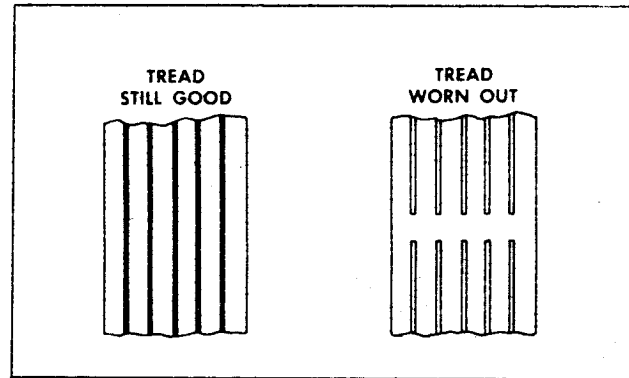

Tire Tread Wear Indicator

Proper replacement wheels can be obtained from GMC Motorhome dealers.

Note: The use of wheels and/or tires with higher load carrying capacity than originally equipped on your vehicle does not increase the GAWR's or the GVWR of the vehicle.

Warranty

Tires are warranted by the tire manufacturers as covered in the New Vehicle Warranty folder.

Tightening Wheel Stud Nuts

When the vehicle is new or after wheels have been replaced, it is the owner's responsibility to

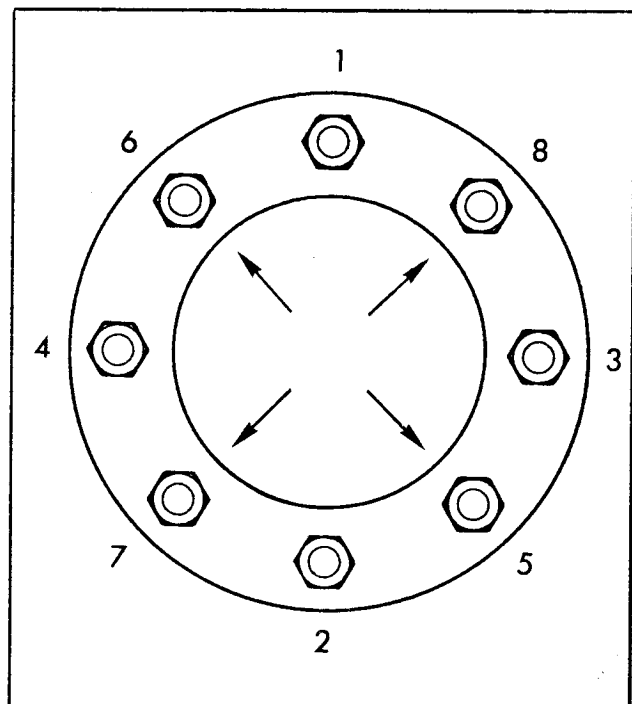

Wheel Stud Tightening Sequence

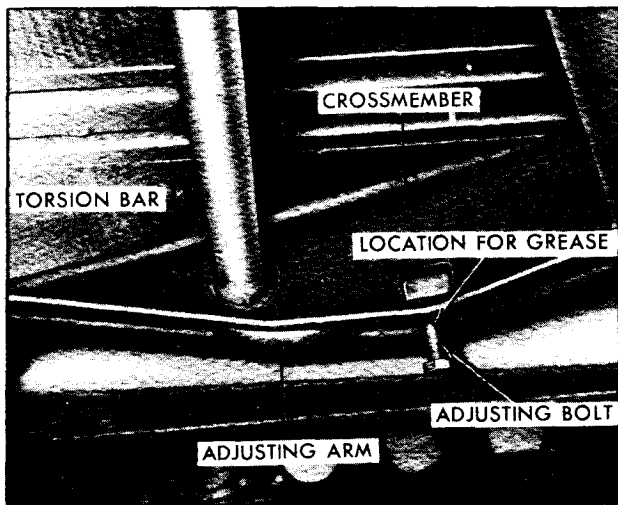

Location—Front Ride Height Adjustment

check wheel stud nuts at 500 miles and every wheel removal thereafter. Nuts should be tightened to 250 foot-pounds torque in sequence shown.

CAUTION

If any wheel experiences a single stud failure caused by a loose-running wheel, all wheel studs should be replaced.

A loose-running wheel may cause only one stud to break, but several more studs may become fatigued to the point of failure, but not actually breaking. Replacing only the broken stud and re-mounting wheel will then set the stage for a second and possibly more serious failure. If holes in the wheel have become elongated or enlarged, replace wheel.

Tighten wheel stud nuts as follows:

1. Install all nuts loosely, then finger-tighten only the nuts marked by arrows.
2. Tighten all nuts to specified torque in sequence illustrated. Never use oil or grease on studs or nuts.

See **IN CASE OF EMERGENCY** section for procedure used to change tire.

REAR WHEEL BEARING ADJUSTMENT

A periodic rear wheel bearing repack is required as indicated in Maintenance Schedule folder. These bearings should be cleaned and repacked with Lithium Soap Multi-Purpose

Grease meeting GM Specification 6031-M or equivalent.

The adjustment of the bearing must be done with the wheel off the floor, and rotating the wheel while tightening nut. At this time make the torque readings as follows:

1. Tighten adjusting nut with a torque wrench to 25-30 foot-pounds with wheel rotating to ensure that all parts are properly seated and threads are free.
2. Back off nut one-half turn. Re-tighten nut finger-tight.
3. If unable to install cotter pin at finger-tight position, back off one slot, then secure with cotter pin.
4. End play should be .001" to .005". Also at this interval the rear suspension control arms should be lubricated. This is accomplished at the fittings between the rear wheels.

FRONT SUSPENSION

The front suspension consists of control arms, stabilizer bar, shock absorbers and a right and left torsion bar. The front suspension components are designed to provide satisfactory service, ride, and handling if not overloaded and adjusted to specified vehicle front end ride height.

No maintenance other than lubrication is normally required. Refer to lubrication information given earlier in this section for intervals and lubrication points.

The front of the torsion bar is attached to the lower control arm. The rear of the torsion bar is mounted into an adjustable arm. The front ride height is controlled by this adjustment.

The simplest way to adjust is to move arm slightly to achieve ride height and drive unit a few blocks so as to overcome delaying action.

NOTE: Ride height is measured from top of elongated slot in frame rail to ground level. Tire inflation should be checked prior to making any ride height adjustment.

Ride height should be adjusted by raising vehicle to relieve strain on adjusting bolt. Lubricate adjusting bolt with chassis grease. Adjustment is made by repositioning adjusting bolt to wind-up and unwind torsion bar. Whenever

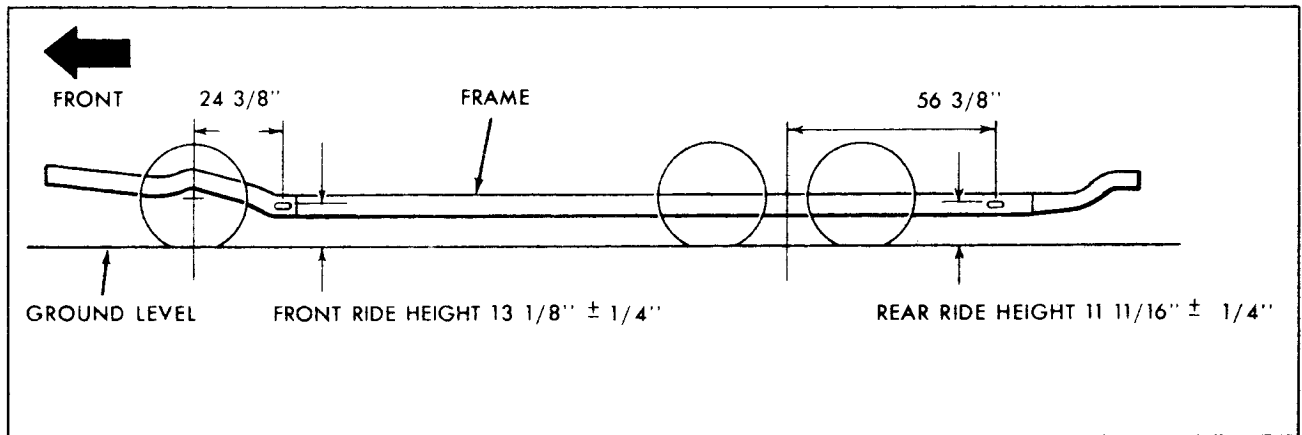

Checking Vehicle Ride Height

ride height is changed, be sure to check front end alignment and readjust if necessary.

NOTE: Overloading and incorrect ride height can create serious problems and shorten the service life of the vehicle. Adjust front suspension ride height to specifications shown.

REAR SUSPENSION

The rear suspension consists of control arms, mounting brackets, air bellows, shock absorbers, air compressor, solenoid valves, wet tank, and height control valves. The system operates automatically as load varies, and is designed to maintain a constant frame height.

NOTE: Ride height is measured from top of elongated slot in frame rail to ground level. Tire inflation should be checked prior to making any ride height adjustments.

The rear suspension can be manually adjusted for variations in load distribution. Adjustment is made at the adjustment nut on the height control valve arm.

MAINTENANCE

1. The wet tank (see illustrations) should be drained at 3 month or 3,000 mile intervals, or more often if above normal air compressor operation is encountered.

NOTE: The rear suspension control components on Model ZEO 6581 are located below the living area electrical compartment. On Model ZEO 6584 the rear suspension control compo-

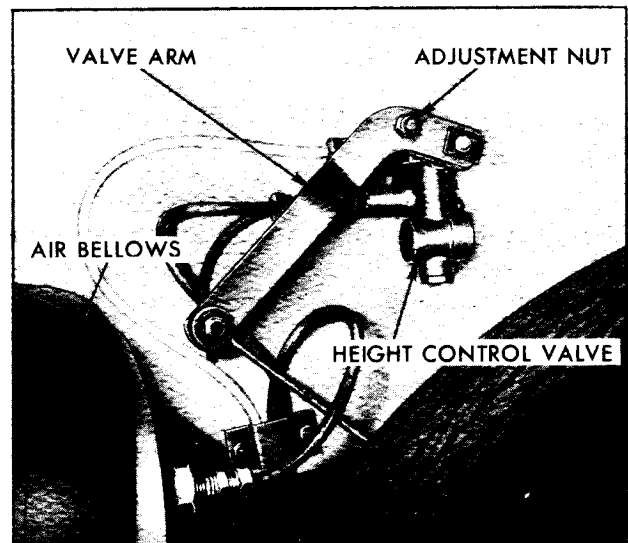

Location—Rear Ride Height Adjustment

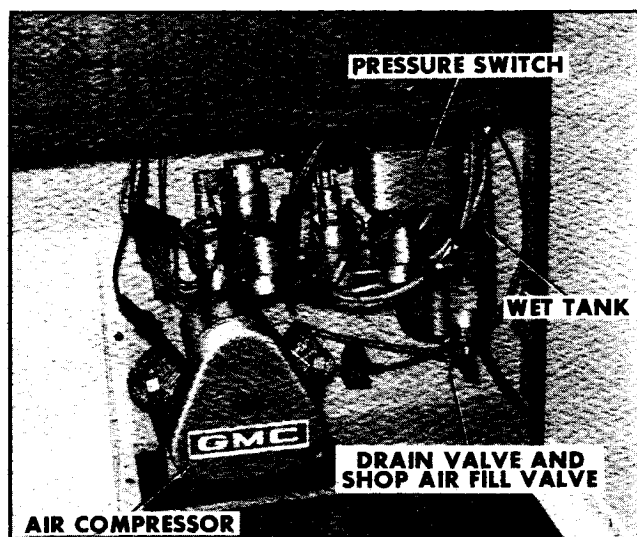

*Rear Suspension Control Components
(ZEO 6581)*

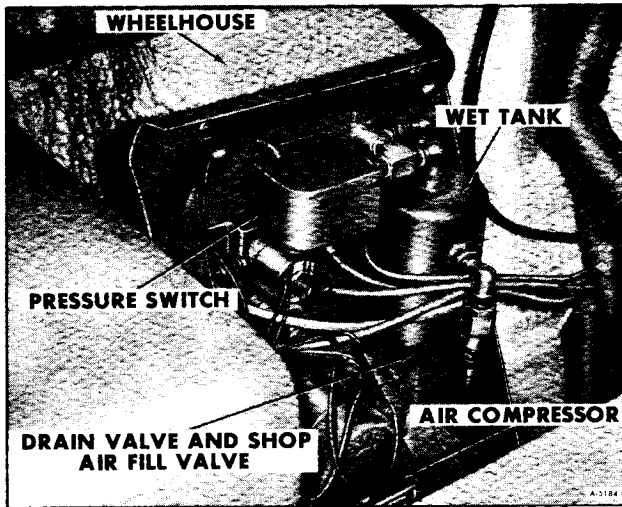

*Rear Suspension Control Components
(ZEO 6584)*

nents are located under the twin bed on the left side of the vehicle.

2. The air compressor must periodically have the air filter washed with soap and water solution or replaced. Filter should be serviced at intervals specified in Maintenance Schedule folder.

NOTE: Occasionally check air bellows to see if they are caked with accumulated mud deposits. If deposits are present remove them from air bellows.

UNDERBODY MAINTENANCE

Corrosive materials used for ice and snow removal and dust control accumulate on the underbody. These materials should be removed by

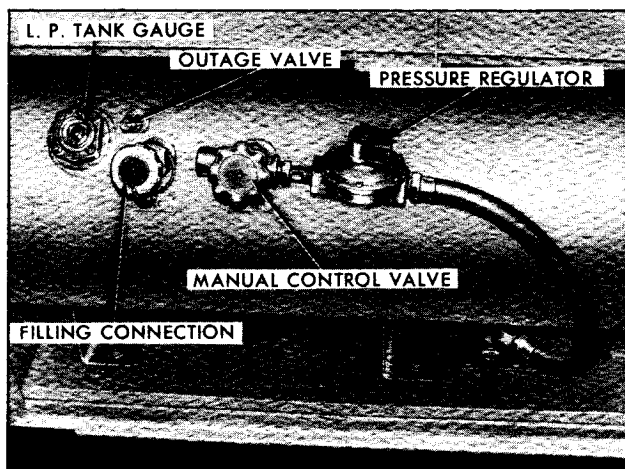

LP Gas Tank Controls (Typical)

flushing the underbody regularly with plain water. Particular attention should be given to cleaning out those areas where mud and other foreign materials collect.

If desired, your Motorhome dealer can perform this service for you. In addition, he can provide recommendations on undercoating materials which will help protect your vehicle from corrosion. (See "Undercoating" in APPEARANCE CARE section.

LP GAS SYSTEM

CAUTION

If gasoline or LP gas fumes are noticed at any time, the cause should be determined and corrected without delay because of the possibility of fire.

Bottled LPG (Liquid Petroleum Gas) is safe, economical, clean and conveniently available. It operates the kitchen stove and furnace in your Motorhome.

The tank is located on the right side of the vehicle in a compartment behind the rear wheels. The tank is accessible only from outside of the vehicle.

The knob on the left is the filling connection. This is where the tank is filled. Next to it is the outage valve, which is designed to prevent the tank from being overfilled. The control valve is next to it. This is where the main LP gas line to the vehicle can be shut off. On the line leading out of the control valve is the regulator valve. It should not be tampered with.

To fill the tank, drive the Motorhome to an LPG Dealer (**DO NOT REMOVE THE TANK**). The Dealer must use a P.O.L. adapter to fill the tank. The adapter is to be inserted into the filling connection. When liquid appears at the outage valve the tank is full.

Always refill empty LP gas tank as soon as possible. Appliances will stop working when the gas supply becomes exhausted.

IMPORTANT: The LP gas tank on your vehicle was purged of moisture prior to shipment from GMC Truck & Coach Division. However, it is recommended to avoid moisture problems from

the LP gas itself, periodically have methyl alcohol added to your tank by a LPG dealer. Always have methyl alcohol added to tank for winter operation, to help prevent moisture from freezing in the LP gas lines or at the pressure regulator.

When you are not using the gas appliances, shut off the control valve on the tank.

You may find that in the southern part of the country only Butane is available for your LPG tank. It will work fine except that at temperatures below 30°F. (-1°C.). Butane is in a liquid state. In this temperature range no vapor is produced to fuel the appliances. If you expect to encounter temperatures below 30°F. (-1°C.), discharge the Butane from the tank and refill the tank with propane gas. Propane gas does not vaporize below a temperature of -44°F. (-42°C.).

When opening the manual control valve to operate the system, open it all the way, then close it one-quarter turn. This will enable you to tell if the valve is open or closed.

CAUTION

BEFORE opening the control valve check that controls for all gas appliances are in the OFF position. If this is not done, LP gas could accumulate inside the vehicle creating a fire or explosion hazard.

DO NOT alter LPG tank in any way. The regulator on the tank is pre-set. DO NOT attempt to adjust it. This should be done by an authorized service outlet.

It is recommended that you travel with your LPG system off. All pilots and burners should be turned off and the control valve on the LPG tank should be off. This should also be done whenever the vehicle will not be in use. This reduces the hazard of leaking gas.

LIVING AREA ELECTRICAL SYSTEM

Both the 12-volt DC and 120-volt AC circuits in the Motorhome living area are designed to be protected by a series of fuses and circuit breakers. The 12-volt living area circuits are protected by automotive-type fuses, and the 120-volt circuits are protected by circuit breakers like those found in modern homes.

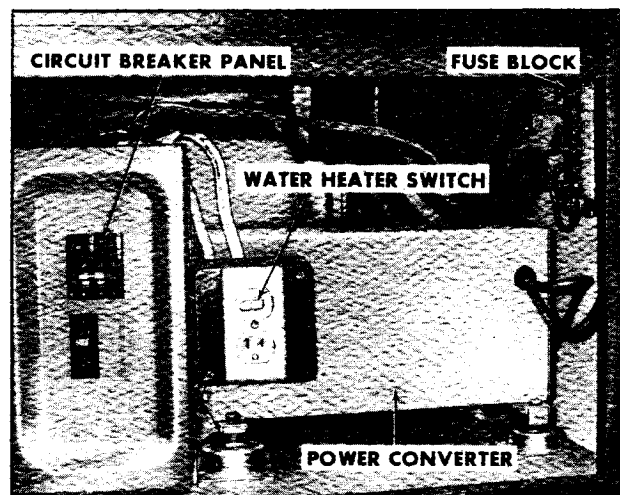

Living Area Electrical Compartment (ZEO 6581)

The 12-volt living area fuse block in Model ZEO 6581 is located in the electrical compartment, next to the hall closet, along with power converter and main circuit breaker panel. In Model ZEO 6584, the fuse block is located in the bathroom vanity beneath the sink. In the event of an overloaded circuit, the cause should be corrected and a new fuse of the same capacity installed. For explanation of 12-volt fuse block number code, refer to **GENERAL DATA SPECIFICATIONS** later in this manual.

The main circuit breaker panel contains circuit breakers that are designed to snap to the "OFF" position in the event of an overloaded 120-volt circuit. Once the cause of the overload is corrected the circuit breaker switch may be moved back to the "ON" position. The circuit breaker panel in Model ZEO 6581 is located in

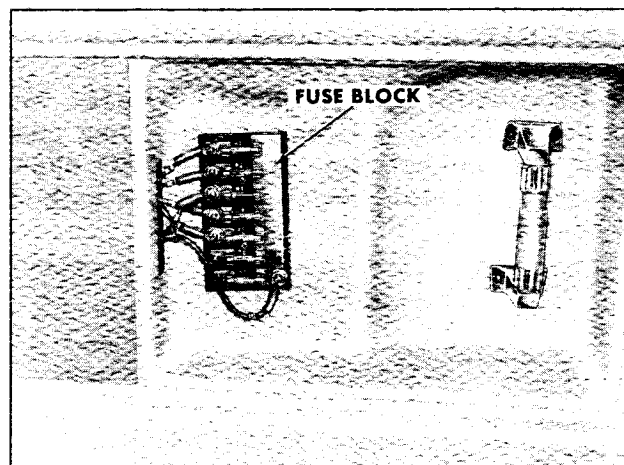

Living Area Fuse Panel (ZEO 6584)

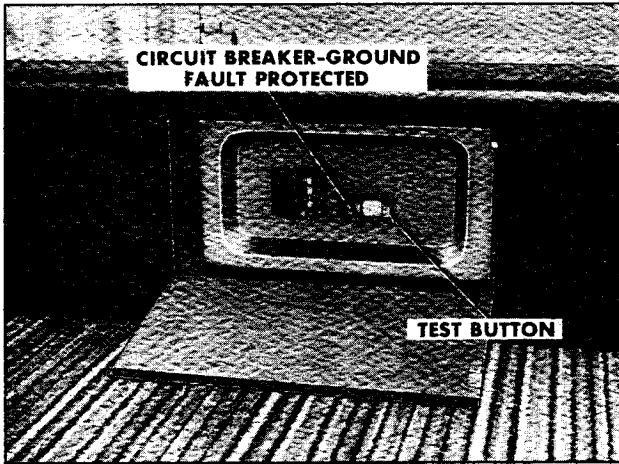

Circuit Breaker Panel (ZEO 6584)

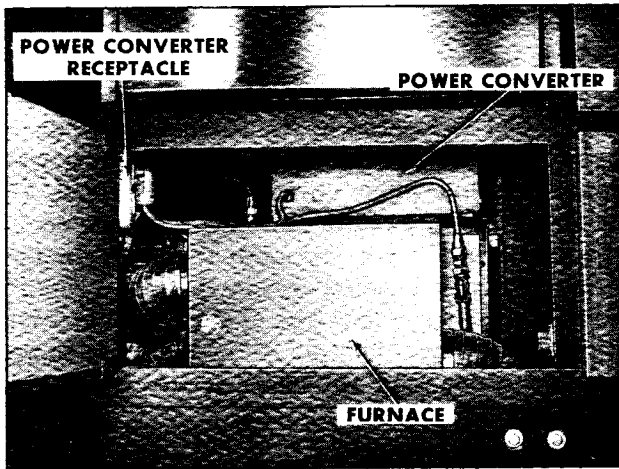

Converter Location (ZEO 6584)

the living area electrical compartment. In Model ZEO 6584, the circuit breaker panel is located at the left rear bed. To gain access to panel, push lightly on access door.

The 120-volt / 12-volt power converter requires no periodic maintenance but care must be taken to ensure a proper flow of air through and around the unit. In Model ZEO 6581, the power converter is located in the living area electrical compartment. In Model ZEO 6584, the unit is located beneath the oven, in back of the furnace.

CAUTION

Do not use living area electrical compartment as a storage area. The power converter must have a free flow of air through and around the unit. If air flow is restricted, the converter could overheat which could result in malfunction and

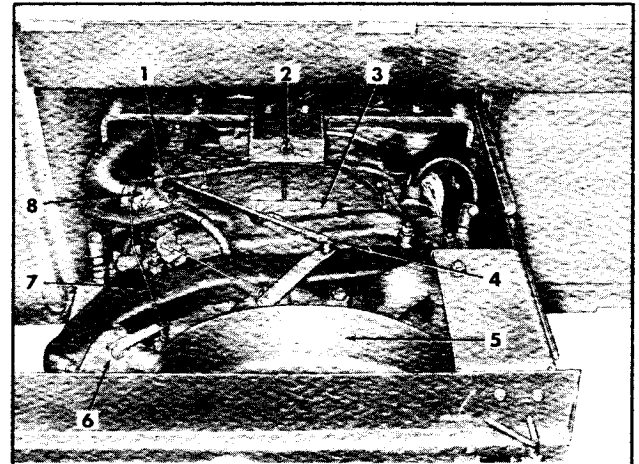

1. VOLTAGE REGULATOR-RECTIFIER
2. CIRCUIT BREAKER
3. BREAKER POINT BOX
4. GOVERNOR LINKAGE
5. BLOWER SCROLL
6. ELECTRIC CHOKE
7. CHOKE LINKAGE
8. CARBURETOR

Onan Motor Generator (Top View)

permanent damage. Do not let unit get wet, but do keep it as clean as possible to help assure its long life. The converter can be cleaned with low pressure air (30 PSI maximum) if necessary.

GROUND-FAULT INTERRUPTER CIRCUIT BREAKER

In Model ZEO 6584, the circuit breaker panel includes a ground-fault interrupter circuit breaker designed to protect you from the hazards of line to ground electric shock.

The ground-fault interrupting circuit breaker is designed to protect people using appliances plugged into the bedroom, galley, dinette, and refrigerator receptacles.

If an appliance continuously trips the circuit breaker, the appliance is defective and should be repaired or replaced.

TESTING THE CIRCUIT BREAKER

For maximum protection against electrical shock hazard, the circuit breaker should be tested at least once a month and the test date recorded.

Test Procedure

1. Push "test" button. The circuit breaker should move to the center position which indicates that power to the protected circuit is discontinued.

2. To restore power, push the circuit breaker to OFF position before resetting circuit breaker.

CAUTION

If circuit breaker does not pop up when the test button is pushed, a loss of ground-fault protection is indicated and a potentially lethal situation exists. Do not use. Have serviced by a qualified electrician.

ONAN MOTOR GENERATOR MAINTENANCE

SERVICE INTERVALS

For service intervals refer to the Maintenance Schedule folder.

CHECKING OIL LEVEL

Check the oil level daily, or at least every eight hours of operating time. Check more often on a new unit as oil consumption is generally higher until piston rings seat properly.

CAUTION

Motor Generator crankcase is pressurized during operation. Do not remove oil filler cap and dipstick while unit is running.

CHANGING OIL

Initial oil change should be made after the first 25 hours of operation; change every 100 hours after that. If operating in extremely dusty or cold weather conditions, change oil more frequently.

The 6KW Model has an oil capacity of 4 quarts; 4½ quarts if replacing oil filter.

Do not mix brands or grades of motor oil. Use a good quality oil with the designation SE/CC. If necessary to add oil between changes, use the same brand and grade of oil.

Use the following chart as a guide for the proper oil according to temperature ranges:

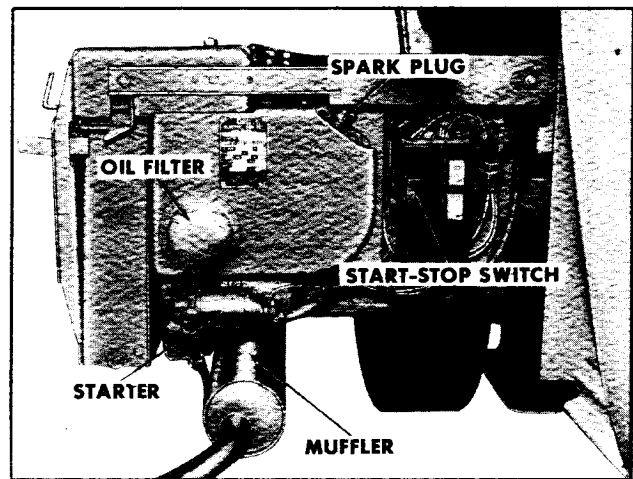

Onan Motor Generator (Right Side View)

TEMPERATURE RECOMMENDED OIL	
Above 30°F. (-1.1°C)	SAE 30
0°F (-17.8°C.) to 30°F. (-1.1°C.)	SAE 5W30 or 10W40
Below 0°F. (-17.8°C.)	SAE 5W30

NOTE: Fill engine with oil through dipstick tube.

The oil drain plug is located on the bottom side of the engine oil base. Unit must be pulled out on its slide rail to gain access.

OIL FILTER

Change the crankcase oil filter at least every 200 hours. The filter is located on the right side of the unit (facing the compartment). Remove by turning counterclockwise with a filter wrench. Before installing new filter, coat the gasket on the filter's base with a light film of new oil. Install by turning clockwise until a light friction is noted, then turn an additional ¼ to ½ turn.

CAUTION

Do not over-tighten filter as damage may occur to rubber gasket which will cause filter to leak. Be sure to install sealing ring around filter; this ring is an air seal to prevent cooling air loss.

FUEL PUMP FILTER ELEMENT

Every 400 hours drain the fuel pump and check filter element. Remove fuel pump mount-

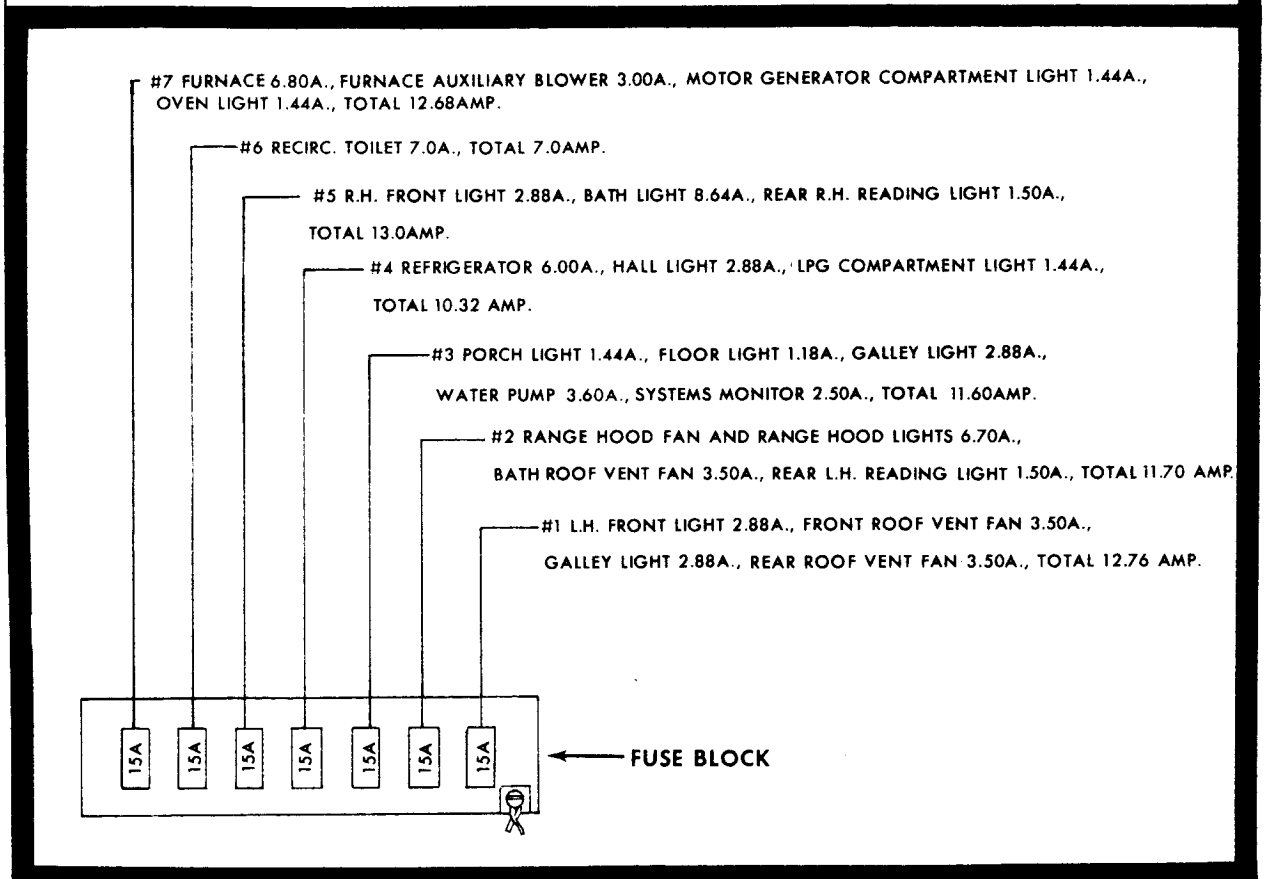
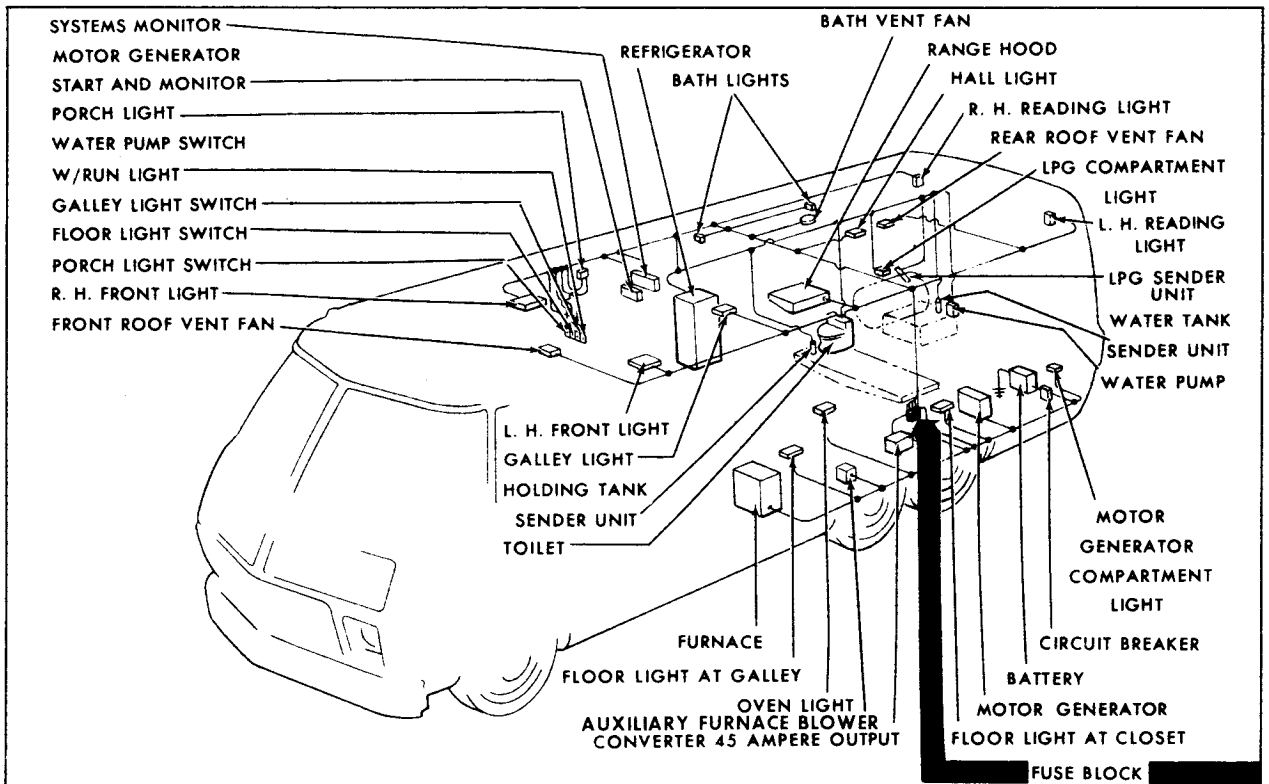

Living Area 12-Volt DC Electrical System (Typical ZEO 6581)

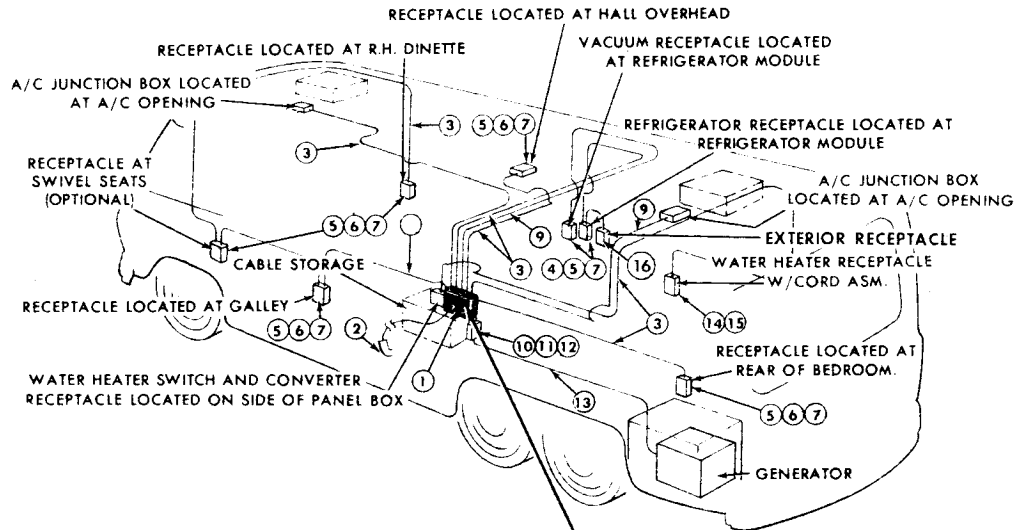

ITEM NO	PART NAME
1	MAIN PANEL BOX
2	#8-4 WIRE CORD TYPE '50' W/PLUG
3	WIRE 12/2 W/GROUND WIRE
4	SINGLE RECEPTACLE
5	OUTLET BOX
6	DUPLEX RECEPTACLE
7	OUTLET PLATE
8	SWITCH & RECEPTACLE
9	14/2 W/GROUND WIRE
10	3 POLE 4 WIRE RECPTACLE
11	OUTLET BOX
12	OUTLET PLATE
13	#6-2 WIRE CORD IN METAL CONDUIT
14	'J' BOX
15	BLANK COVER PLATE
16	EXTERIOR RECEPTACLE

CIRCUIT BREAKER PANEL				
CIRCUIT #1	CIRCUIT #2	CIRCUIT #3	CIRCUIT #4	CIRCUIT #5
FRONT AIR COND. RECEPT.	WATER HEATER RECEPT.	HALL OVER RECEPT.	VACUUM RECEPT.	REAR AIR COND. RECEPT.
	CONVERTER RECEPT.	BEDROOM RECEPT.		
		GALLEY RECEPT.		
		SWIVEL CHAIR RECEPT.(OPT.)		
		R.H. DINETTE RECEPT.		
		REFRIGERATOR RECEPT.		
		EXTERIOR RECEPT.		

120-Volt AC Electrical System (Typical ZEO 6581)

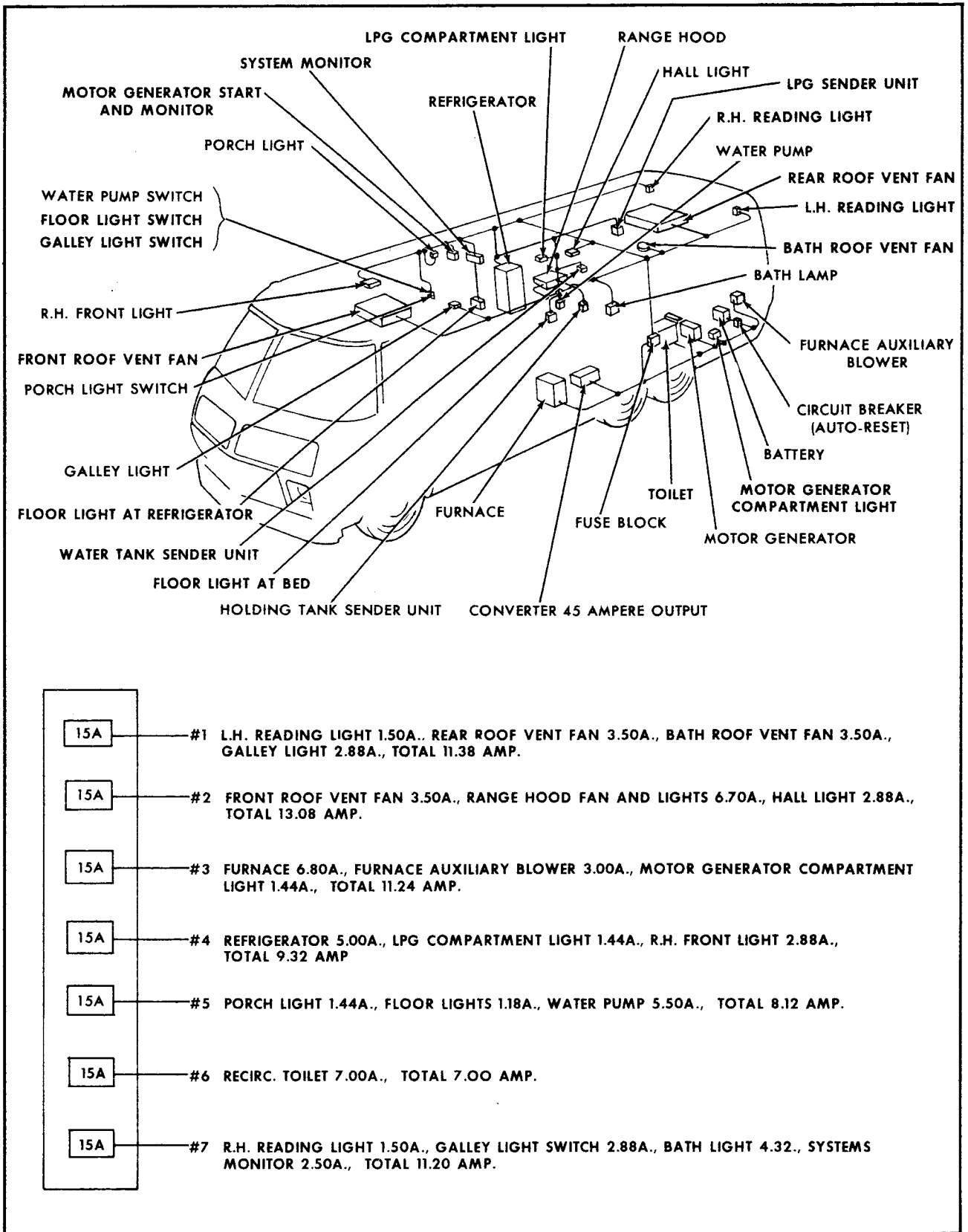

Living Area 12-Volt DC Electrical System (Typical ZEO 6584)

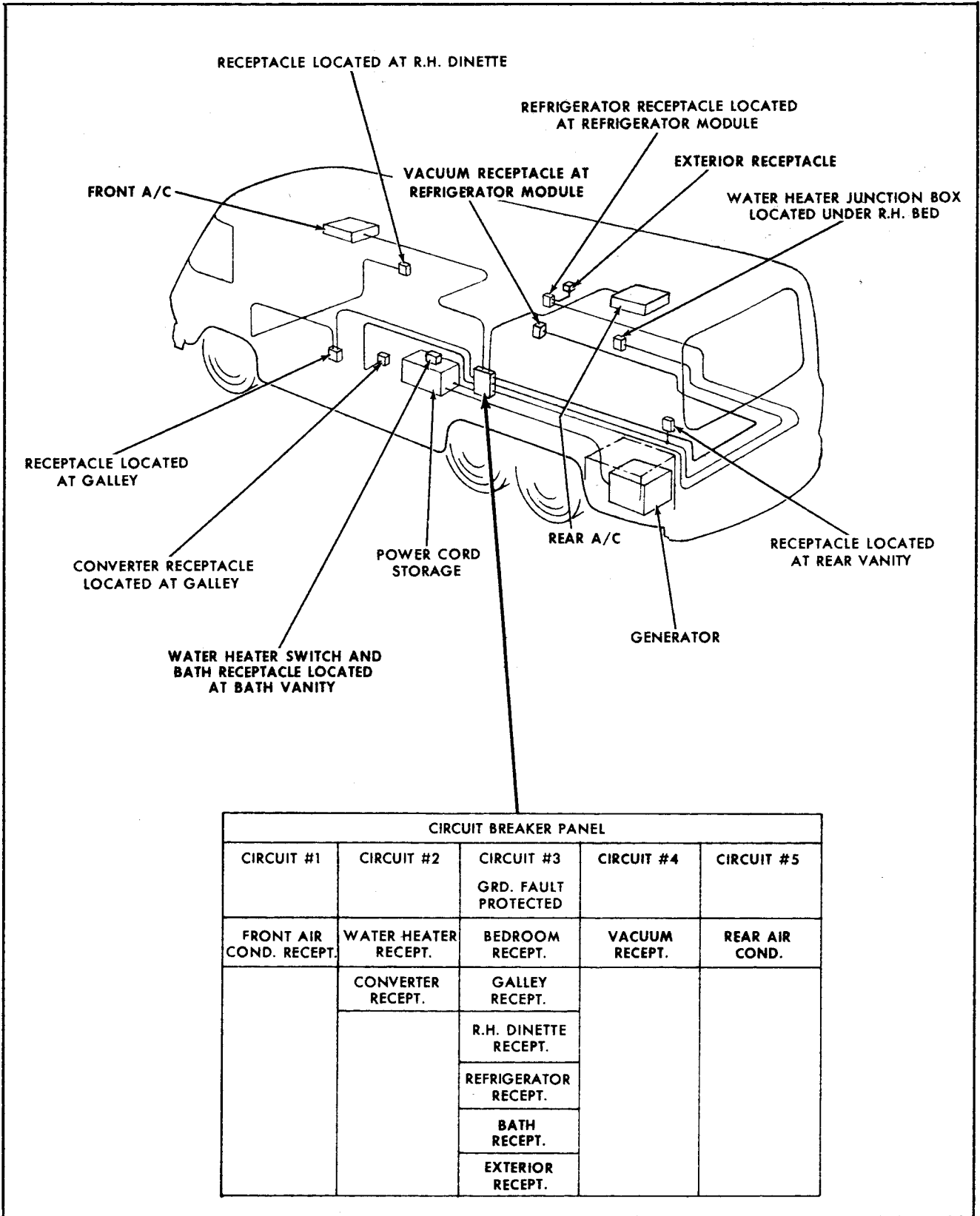

120-Volt AC Electrical System (Typical ZEO 6584)

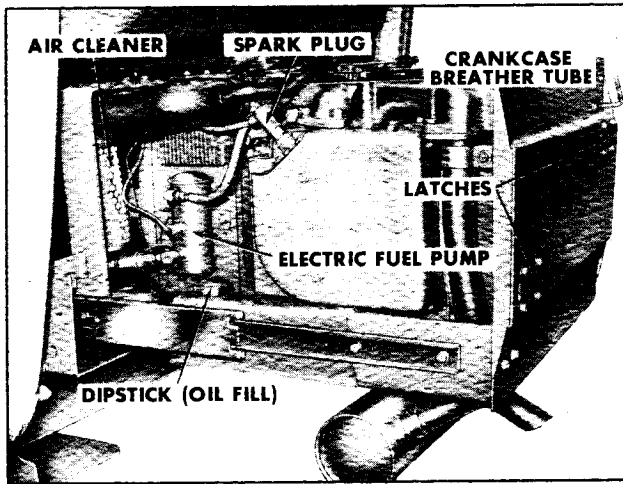

Onan Motor Generator (Left-Side View)

ing screws and turn off hex nut on base of pump. If element appears dirty, replace with a new one. Be sure to replace gaskets when reassembling.

GOVERNOR

The governor controls the speed of the unit by opening or closing the throttle according to the load placed on the motor generator. Every 200 hours check governor linkage for freedom of movement through its entire travel. Clean and lubricate ball joint with graphite.

BATTERY

Motor generator is cranked from auxiliary (living area) battery. See "Chassis Electrical System" earlier in this section.

SPARK PLUGS

Check, clean and reset spark plugs every 100 operational hours. Replace spark plugs that show signs of fouling or electrode erosion. It is recommended that spark plugs be replaced at the beginning of each new season.

COOLING SYSTEM

The motor generator is cooled by a flywheel blower fan which pulls air over the cylinders and cooling fins. The air path is directed by sheet metal shrouds and plates. These shrouds and plates must always be installed properly so unit does not overheat.

Check and clean the cooling fins every 200 hours of operation. Remove any dust, dirt or oil which may have accumulated. Check com-

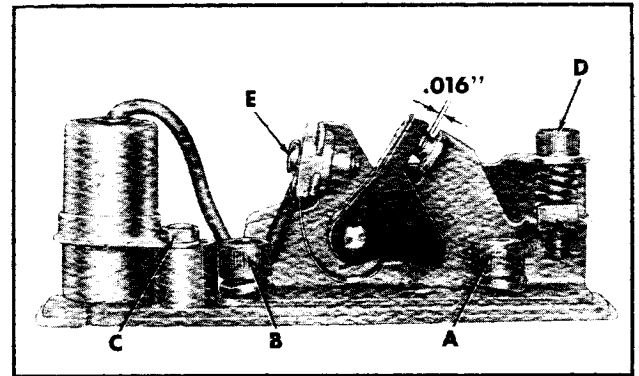

Onan Breaker Point Adjustment

partment air inlet and air outlet for build-up of dirt, etc.

AIR CLEANER

Check and clean the air cleaner element at least every 100 operational hours. Loosen wing nut to remove. Clean by tapping base lightly on a flat surface. Replace element at least every 500 hours on the 6KW Model. Clean or replace more often in dusty conditions.

CAUTION

Do not remove the air cleaner unless temporary removal is necessary during repair or maintenance. When the air cleaner is removed backfiring can cause fire in the generator compartment.

BREAKER POINTS

To maintain maximum efficiency from the unit, check the breaker points every 100 hours and, change the breaker points every 200 hours of operation. To change the breaker points use the following procedure:

1. Remove the single screw and the cover on the breaker box.
2. Remove the two spark plugs so the engine can easily be rotated by hand. Check condition of spark plugs at this time.
3. Using a screw driver, remove mounting screw (C). Use an allen wrench to remove mounting screws (A) and (B). Remove points and condenser.
4. Replace points and condenser with a new set. Tighten screws (A), (B), and (C).
5. Remove the access hole cover on the top of the blower housing. This provides an access to view timing mark.

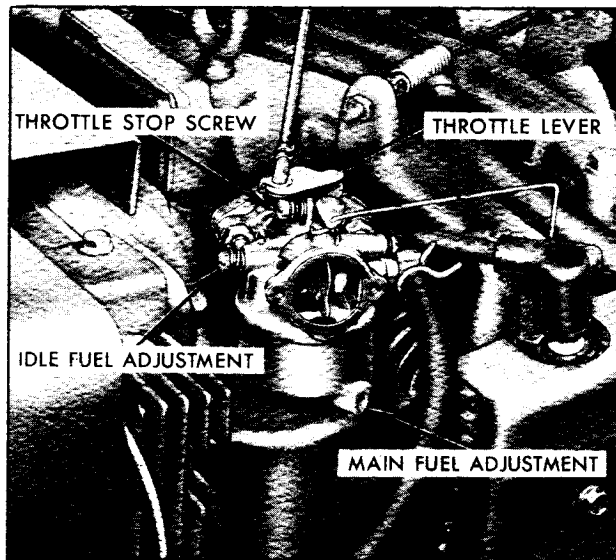

*Onan Motor Generator
Carburetor Adjustment Points*

6. Rotate the engine clockwise (facing flywheel) by hand until mark on gear cover aligns with mark on flywheel. On the 6KW Model, rotate it to the 21° BTDC mark. Turn another ¼ turn (90°) to ensure points are fully open.

7. Using an allen wrench inserted in screw (D) on the right side of the points, turn points until gap measures .016 with a flat thickness gauge (be sure gauge is clean). Replace cover and screw on breaker box.

CARBURETOR

The carburetor has a main fuel (power) adjustment and an idle fuel adjustment. The main adjustment affects operation under heavy load conditions. Idle adjustment affects operation under light or no-load conditions. Under normal circumstances, factory carburetor adjustments should not be disturbed.

On the 6KW Model the normal settings are 1½-turn open for main fuel adjustment and one turn open for idle fuel adjustment.

IMPORTANT: Forcing the needle against its seat will damage it. The needle does not completely shut off fuel when turned fully in.

Before final adjustment, allow the engine to warm up. Make the idle adjustment under no load. Open the main fuel adjustment until the engine runs smooth under acceleration with no load. Slightly more fuel may be needed (open

about ¼-turn further) when sudden load is applied or if operating in very cold weather. Set the throttle stop screw with no load connected and while running at a low speed setting. Turn the screw to give approximately 1/32-inch between the throttle stop screw and throttle lever.

If the engine develops a "hunting" condition (alternate increase and decrease of engine speed), try correcting by opening the main fuel adjustment a little more. Do not open more than ½ turn beyond the maximum power point.

STANDARD TOILET

There is no routine maintenance required on the standard toilet. If a problem occurs, check and make the appropriate correction.

1. PROBLEM:

- Water keeps running into the bowl.

CAUSE:

- The blade in the bottom of the bowl is not closing completely, which in turn keeps the water control valve partially open. The groove into which the blade seats when completely closed is clogged with foreign material. Odors could also leak up into vehicle.

SOLUTION:

- Depress foot pedal to expose blade seal.
- Insert the end of a coat hanger or similar object into the seating groove and remove the foreign material. Avoid damaging the rubber seal while cleaning.

2. PROBLEM:

- Toilet leaks. There is water on the floor.
- Specify the symptom. Determine if water is leaking from:
 - a. The vacuum breaker.
 - b. The water control valve.
 - c. Bowl to mechanism seal (if this is the problem, the water would not stay in the bowl).
 - d. Closet flange base seal.

SOLUTION:

- a. The vacuum breaker—if the vacuum breaker leaks when flushing the toilet, replace the vacuum breaker. (Toilet must be removed.)
- b. If the vacuum breaker leaks when the toilet is not in operation, replace the water control valve.
- c. Leaks at the bowl to mechanism seal—remove mechanism, and replace mechanism seal.
- d. Leaks at closet flange area—check front and rear closet flange nuts for tightness. If leak continues remove the toilet, check the closet flange height. The height should be between 1/4" and 7/16" above the floor. Adjust closet flange height accordingly and replace closet flange seal.

3. PROBLEM:

- Foot pedal operates harder than normal or blade sticks.

SOLUTION:

- Dry blade and apply a light film of Silicone spray to blade.

4. PROBLEM:

- Toilet fails to flush with pedal depressed.

CAUSE:

- Ball valve sheared off due to trying to flush toilet when water is frozen in valve.

SOLUTION:

- Replace ball valve. (Toilet must be removed.)

RECIRCULATING TOILET

Routine maintenance is not required on the recirculating toilet other than recharging which is described in OPERATION OF LIVING AREA FACILITIES section earlier in this manual. If a problem occurs, check and make the appropriate correction.

1. PROBLEM:

- Toilet wobbles.

CAUSE:

- a. Closet retaining nuts not tight.
- b. Mounting brackets not seated to floor.
- c. Closet flange too high.
- d. Mounting surface uneven.

SOLUTION:

- a. & b. Tighten closet retaining nuts.
- c. & d. Check closet flange height by laying straight edge across flange and measuring gap between straight edge and floor at four (4) leg locations (1/4 to 7/16 inch is recommended).

2. PROBLEM:

- Flushing action is weak or noisy.

CAUSE:

- a. Pump is running backwards (reversed wiring polarity).
- b. Cycling unit without enough charge water.
- c. Pump damaged by continuous dry operation.

SOLUTION:

- a. The black wire is positive (hot) and the white wire is negative (ground).
- b. Charge to proper level (3 gallons). Fill to charge level (c) on indicator lens.
- c. Replace pump assembly.

3. PROBLEM:

- Lack of capacity.

CAUSE:

- Too much charge water.

SOLUTION:

- Use three gallons only to charge. Fill to charge level (c) on indicator lens.

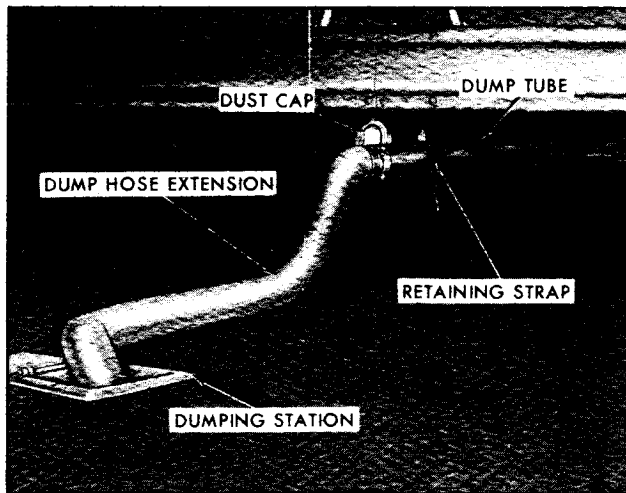

Dumping Station Connection

DRAINING HOLDING TANK

NOTE: If holding tank is allowed to overflow, the overflow will back up through the bathroom shower drain.

1. Be sure the holding tank valve is closed. It is located on the left-hand side of the vehicle just behind the left rear tandem tire.
2. Remove dump hose extension from the storage tube inside rear bumper.
3. Disconnect dump tube retaining strap mounted to center of rear crossmember. Remove dust cap from pump tube.
4. Join dump tube extension to dump hose by rotating adapter clockwise.
5. Put end of dump hose extension into sanitary dumping station opening. Make sure there are no sags in hose as this would prevent complete dumping.
6. Release two snap retainers at the control valve and pull handle straight out to open. This will drain holding tank completely.

NOTE: If you are using a sewer hook-up in a RV park keep the valve closed until you leave or the holding tank becomes full. This will allow solids to drain more readily.

7. After the holding tank is empty, it is recommended that the control valve be closed and several gallons of water be added to tank through the toilet. Then pull handle out to rinse

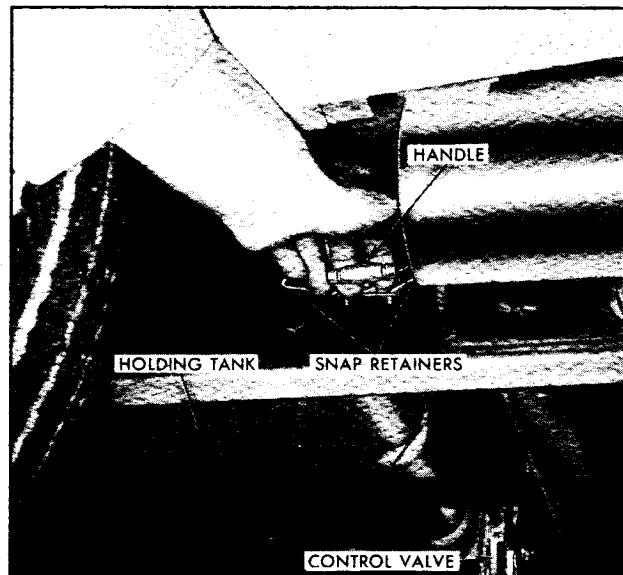

Opening Holding Tank Control Valve

tank. A garden hose may be left running into toilet with valve open to further rinse dump hose and extension.

8. It is advisable to add about ½-gallon of water and some non-toxic, non-flammable odor-control type chemical to holding tank.
9. Be sure to push control valve handle back in as far as it will go and re-latch two snap retainers to assure valve will be positively locked while traveling.
10. Restore dump extension to storage tube located inside rear bumper.

WATER SYSTEM DRAINING LIVING AREA

1. Remove the water tank fill cap.
2. Open the holding tank dump valve, after making proper connection to approved dumping station.
3. Turn off water heater at switch located on model ZEO 6581 in Living Area Electrical Compartment, and on model ZEO 6584 in bathroom on wall behind, and to the left of, sink.

NOTE: To gain access to water compartment on model ZEO 6581 remove trim panel and water compartment access door of rear right-hand seat, on model ZEO 6584 lift the top of the rear, right-hand bed.

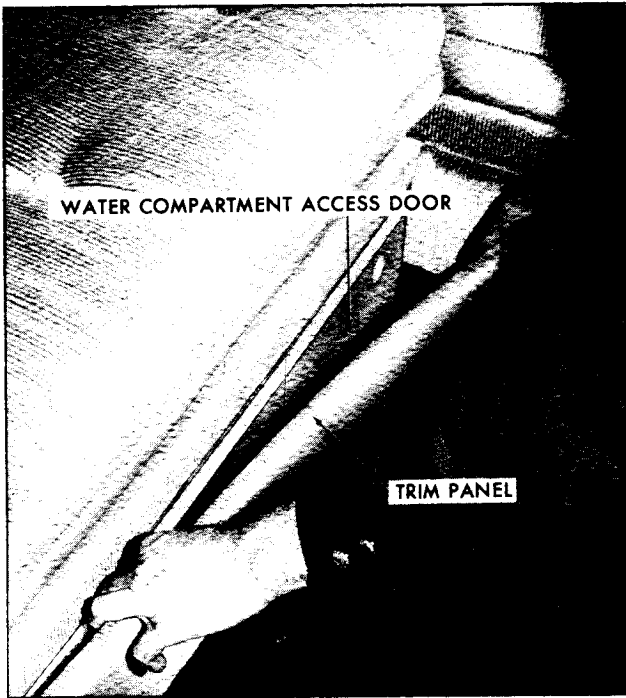

Access to Water Pump and Controls (ZEO 6581)

4. Open the water drain valves at the water pump and the water tank, and the two water line drain cocks at the kitchen sink. To gain access to water line drain cocks for kitchen sink remove the second drawer located to the left of the kitchen sink compartment door. Open the water heater drain valve.

5. Open kitchen and bathroom faucets.

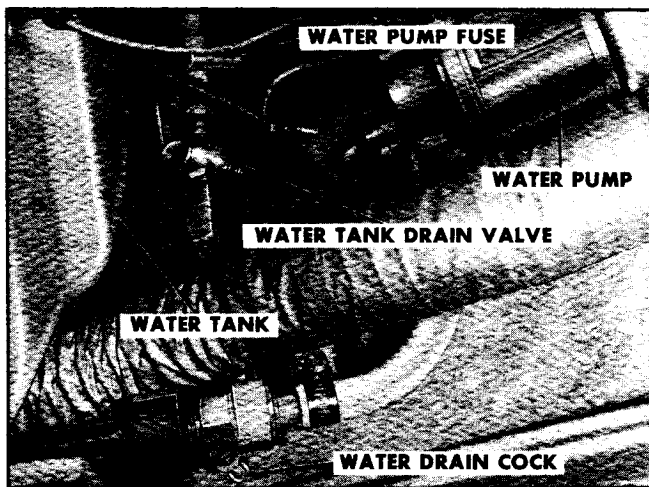

Water Tank Compartment (Typical ZEO 6581)

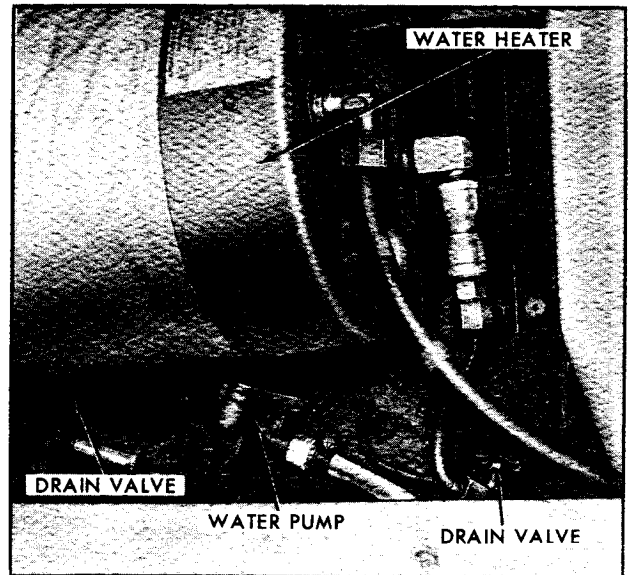

Water Tank Compartment (Typical ZEO 6584)

6. Turn on water pump (if not already running).

7. With the standard toilet, depress the foot pedal until water no longer enters the toilet bowl.

8. Allow system to drain.

9. Turn off water pump.

10. With the recirculating toilet, open the toilet water line fill valve, open dump valve, and momentarily press the flush button.

11. Open shower head shut-off valve and turn the shower on. Extend shower head toward sink drain on model ZEO 6581 and shower stall drain on model ZEO 6584. Allow the shower head and flexible hose to drain.

12. On model ZEO 6581 remove access cover near lower shelf in closet. Open drain valve for external water connection. On all Motorhomes, at the external water connection (inside external utilities compartment), remove hose connection cover. Depress momentarily the button on the check valve to allow this portion of plumbing to drain. Install hose connection cover.

14. Using low pressure (30 psi maximum), blow back through all faucets, forcing water from any low areas.

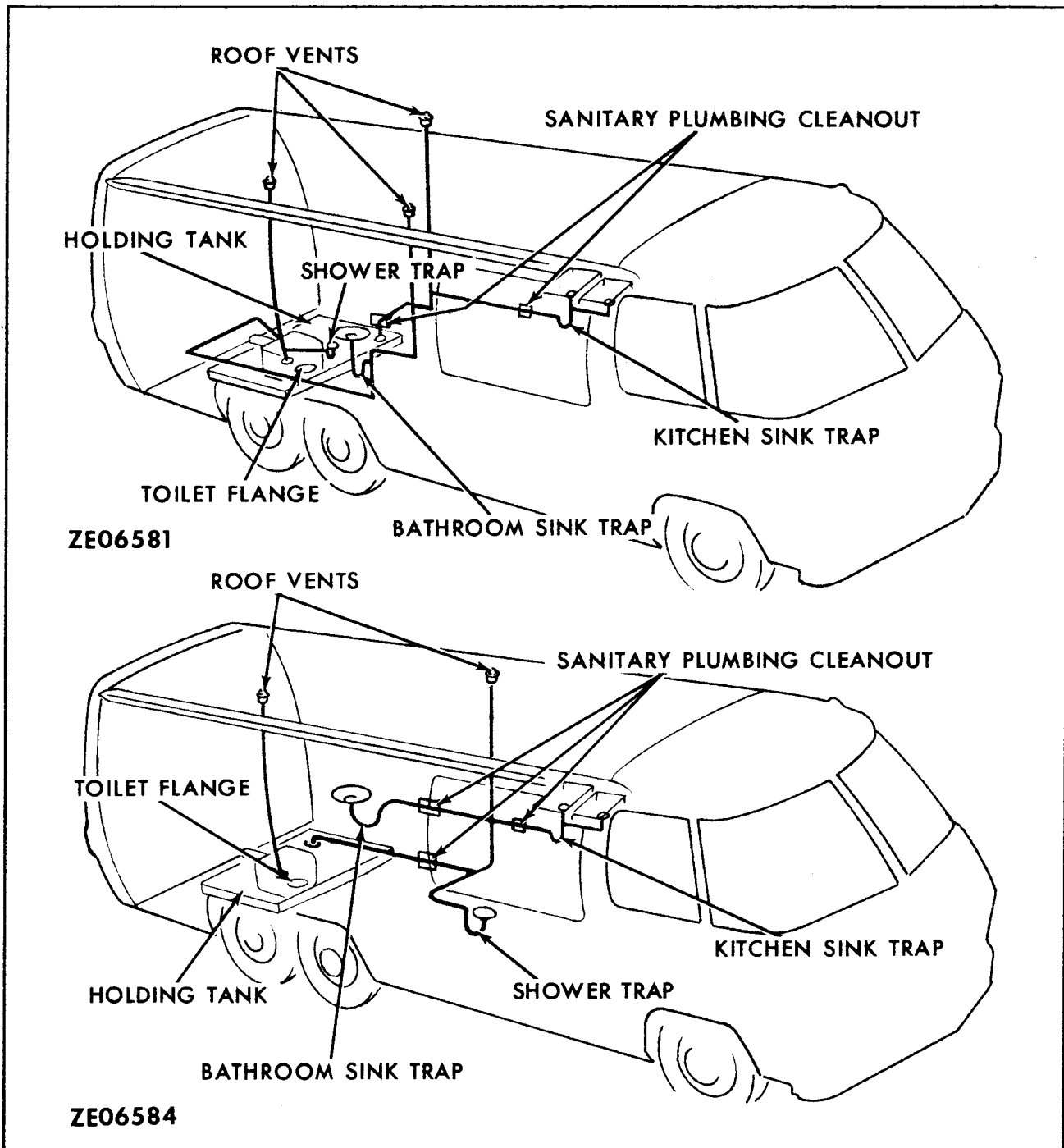

Drainage System (Schematic)

15. Connect water pump hoses and close all the water line drain cocks and valves including the water heater drain cocks. Close kitchen and bathroom faucets, close toilet water line valve (if equipped). Close holding tank dump valve and latch. Stow holding tank tubes and replace dust cap. Install water tank fill cap.

WATER TANK FILTER

When water flows from the fresh water tank it circulates through the water tank filter before entering the water pump.

The water tank filter, which is located in the water compartment, is transparent and should

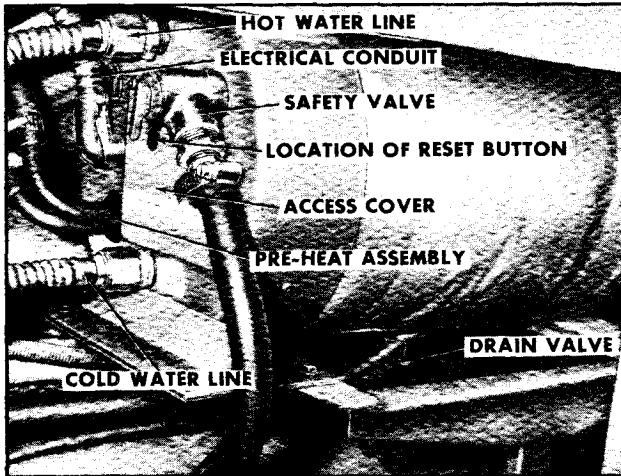

Water Heater (Typical)

be checked periodically and cleaned annually.

A helpful sign that filter is dirty is when the transparent filter has become discolored.

Removing filter from water lines

1. Turn water pump and water heater switches to "OFF" position.
2. Drain water tank.
3. Disconnect the two clamps that attach water filter to water line hoses.
4. Separate filter from hoses.

Disassembly of water filter

1. Remove screws which attach filter.
2. Remove filter screen.
3. Clean filter and screen with water and a soft nylon bristle brush.

Assembly of water filter

1. Place filter screen into filter.
2. Assemble filter together with screws.

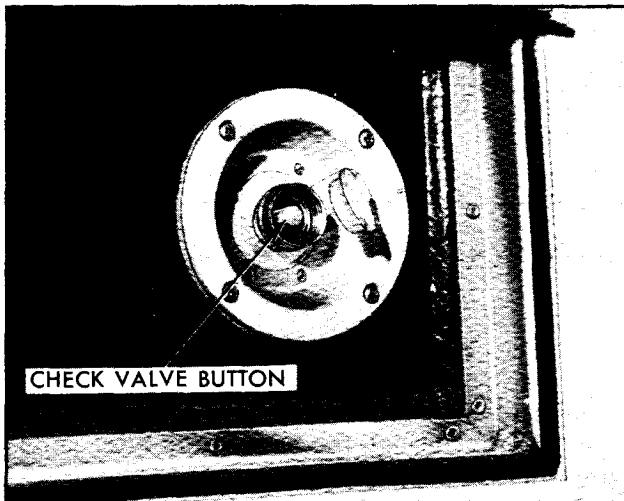

External Water Connection

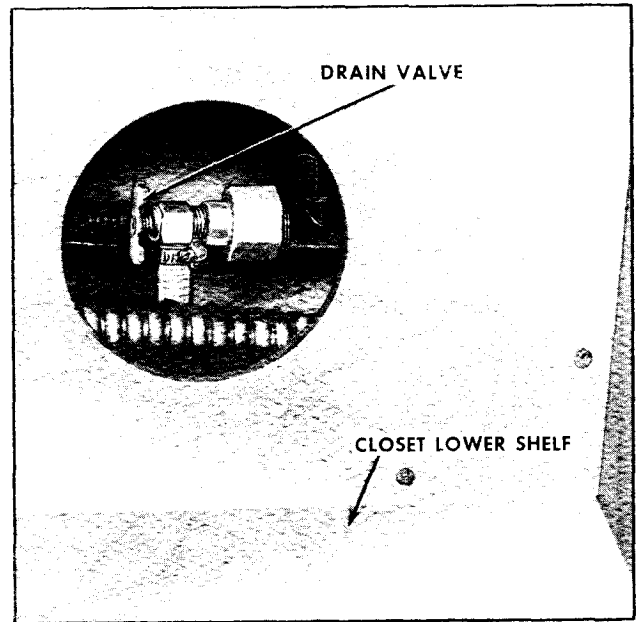

External Water Connection Drain Valve (ZEO 6581)

Installation of water tank filter

1. Attach filter to water line hose connections.
2. Tighten hose clamps.
3. Refill water tank.

SANITIZING LIVING AREA WATER SYSTEM

To help assure complete sanitation of your living area water system, it is recommended that the following procedures be followed on a new system, one that has not been used for a period of time, or one that may have become contaminated:

IMPORTANT: Be sure inlet valve to water purifier cartridge is closed while sanitizing living area water system.

1. Prepare a chloride solution using one gallon of water and 1/4 cup of household bleach (5% sodium hypochlorite solution). Pour one gallon of solution into water tank for each 15 gallons of tank capacity.
2. Complete filling of tank with fresh water. Open each faucet and drain cock until all air has been released from the pipes and entire system is filled.
3. Allow to stand for three hours.
4. Drain and flush with potable (drinkable) fresh water.

5. To remove any excessive chlorine taste or odor which might remain, prepare a solution with one quart of vinegar to five gallons of water and allow this solution to agitate in tank for several days by vehicle motion.

6. Drain tank and again flush with potable water.

WINTERIZATION

When traveling in winter it is recommended that the water tank not be filled until the destination is reached. This will ensure that the vehicle has thoroughly warmed up. The water and holding tank systems should be drained before leaving for home. Also, an approved plastic pipe non-toxic, non-flammable antifreeze should be put in the sink and shower traps. If equipped with a recirculating toilet the standard winterization is to replace one-half of the charge water with an approved non-toxic, non-flammable antifreeze. This antifreeze added to the holding tank will help keep the tank contents from freezing.

See "Vehicle Storage" for additional information.

VEHICLE STORAGE

Your Motorhome may be stored for considerable lengths of time provided the following steps are performed:

1. SHORT TERM STORAGE—UP TO 60 DAYS AND ABOVE 32°F. (0°C.)

a. Fill fuel tanks to reduce excessive build-up of moisture in the fuel tanks.

b. Park Motorhome as level as possible, end for end and side to side.

c. Wash Motorhome. If exposed to road salts the exterior and underside should be thoroughly washed and flushed.

d. Remove all perishables, leave refrigerator door open. Be sure controls are turned off.

e. Ventilate the living area, drawers, cabinets, closets, etc.

f. Drain the holding tank, toilet and living area water system as described earlier in this section. Be sure the water pump and water heater are turned off.

g. Turn off LP gas at tank valve.

h. Make sure furnace manual valve and thermostat are set at "OFF," range/oven burners at "OFF," oven at "PILOT OFF." If equipped with gas/electric refrigerator be sure gas is turned off at unit's control panel.

i. Plug or tape all drains to retard evaporation of residual moisture in drain traps.

j. Tape over vents to prevent insects from entering. Be sure to remove tape before operating LP gas appliances, to help avoid poisoning by carbon monoxide (see caution at beginning of section on OPERATION OF LIVING AREA FACILITIES).

k. Check Motorhome weekly to ensure that undesirable conditions are not forming (water seepage, mold, odors, etc.). Household air deodorizers or disinfectants in aerosol cans may be used as required, however, do not spray directly on any surface.

l. Maintain proper tire pressure.

m. Crack one window for ventilation, close all others as well as roof vents.

n. Check batteries (main and auxiliary) for charge. Specific Gravity reading of 1.255 is required to prevent deterioration. Add colorless, odorless drinking water if necessary.

o. Turn off radio, exterior lights, and interior lights.

p. If Motorhome is to be moved, run engine at least two minutes with the transmission selector in "PARK."

q. Start and run engine for approximately 15 minutes weekly. Check engine, transmission and motor generator oil levels. Dipsticks should always be properly seated on tubes to prevent moisture from entering.

2. LONG TERM STORAGE — 60 DAYS OR MORE AND ABOVE 32°F. (0°C.)

a. Perform all of the above steps except Step q.

b. Motorhomes with automotive air conditioning: run engine approximately 15 minutes with automotive air conditioning controls turned to "ON" position. Perform this operation every 30 days.

c. Treat all bright metal and rubber surfaces with a wax emulsion applied with a brush. A good liquid floor wax or equivalent is satisfactory.

d. Disconnect batteries, and check Specific Gravity every 30 days. See additional instructions for batteries under "Chassis Electrical System" given earlier in this section.

3. WINTER STORAGE—BELOW 32° F. (0° C.)

a. While many of the steps in preparing your Motorhome for storage when temperatures go below 32° F. are the same as preparing for storage above 32° F., freezing temperatures present an additional hazard.

b. Fill fuel tanks to reduce excessive build-up of moisture in the fuel tanks.

c. Check coolant level and add antifreeze if required, to protect to the lowest expected temperature during storage (at least -20° F.) (-29° C.) (-37° C. in Canada).

d. Change engine oil as shown on the recommended S.A.E. Viscosity Chart to aid cold weather starting.

e. Park Motorhome as level as possible, end for end and side to side.

f. Wash Motorhome. If exposed to road salts, the exterior and underside should be thoroughly washed and flushed.

g. Remove all perishables and anything which may freeze (canned goods, medicine, etc.). Leave the refrigerator door open. Be sure controls are turned off.

h. To ventilate living area, open drawers, cabinets, closets, etc. If equipped with water purifier, remove cartridge assembly to avoid possible freezing.

i. Drain the holding tank, toilet and living area water system as described earlier in this section. Flush toilet. If equipped with recirculating toilet, charge with antifreeze solution (1½ gallons non-toxic, non-flammable antifreeze and 1½ gallons water). Be sure the water pump and water heater are turned off. Also, be sure the water purifier cartridge assembly is removed from vehicle and stored in a heated facility.

CAUTION

Never add recreational vehicle antifreeze (non-toxic, non-flammable antifreeze) to the living area water tank. Not only would this be wasted expense, in winterizing vehicle, but this will result in cracking and ultimate failure of the living area water tank.

j. Turn off LP gas tank valve.

k. Make sure furnace manual valve and thermostat are set at "OFF," range/oven burners at "OFF," oven at "PILOT OFF." If equipped with gas/electric refrigerator be sure gas is turned off at unit's control panel.

l. Add non-toxic, non-flammable antifreeze (½ cup) to the kitchen, bathroom, and shower drains.

m. Tape over drain openings (except toilet) to prevent evaporation if storage is lengthy (6 months or more).

n. Crack one window for ventilation, close all others as well as roof vents.

o. Start and run engine weekly for approximately 20 minutes. If very low temperatures are expected the batteries should be removed and stored in a warmer area.

p. Check engine transmission and motor generator (if equipped) for evidence of oil leaks.

q. Maintain proper tire pressure.

r. Remove accumulations of snow as often as possible.

s. Turn off radio, exterior lights, and interior lights.

t. Tape over vents to prevent possible entry of snow. Be sure to remove tape before operating LP gas appliances, to help avoid poisoning by carbon monoxide (see caution at beginning of section on OPERATION OF LIVING AREA FACILITIES).

u. Before moving, run engine at least two minutes with the transmission selector in "PARK" position.

v. Drain moisture from suspension wet tank.

MOTOR GENERATOR STORAGE

If the motor generator will be out of service for more than 30 days, the following steps should be taken to protect the unit.

1. Run the unit until thoroughly warm.
2. Disconnect fuel supply and run until unit stops.
3. Drain oil from crankcase while still warm. Refill and attach a tag stating oil viscosity used.
4. Remove each spark plug. Pour one ounce of rust inhibitor (or S.A.E. 50 oil) into each cylinder. Crank engine several times. Install spark plugs.
5. Service air cleaner.
6. On Onan units, clean governor linkage and protect by wrapping with a clean cloth.
7. Plug exhaust outlet to prevent entrance of moisture, dirt, bugs, etc.
8. Wipe entire unit with a clean cloth. Coat rustable parts with a light film of grease or oil.

VEHICLE TRIP PREPARATION

The trip preparation is designed to prepare the Motorhome for an extended trip or vacation. Following the preparation list will aid in providing convenience and proper operation of the vehicle.

SPRING AND/OR SUMMER TRIP PREPARATION

Exterior

- a. Fill LP gas tank.
- b. Sanitize and fill water tank.
- c. Empty and deodorize holding tank.
- d. Check that all exterior vents are unobstructed.
- e. Drain moisture from suspension air reservoir.
- f. Check operation of the following lights:
 - Headlights
 - Parking and turn signals
 - Tail and stop
 - Emergency flashers
 - Back up lights
 - Marker and clearance
 - License

- g. Check the following fluid levels
 - Engine oil
 - Batteries (If maintenance-free battery, check charge or test indicator)
 - Engine coolant
 - Windshield washer reservoir
 - Motor generator oil
- h. Check tires for pressure and wear.
- i. Wash Motorhome
- j. Check windshield wipers for wear

Interior

- a. Check the operation of the following:
 - Electro-level system
 - Wipers and washers
 - All interior lights
 - Range/Oven
 - Refrigerator
 - Air Conditioner
 - Automotive
 - Roof-mounted
 - Vent fans
 - Water pump
 - Water heater
 - Faucets (includes shower)
 - Toilet-Charge recirculating toilet
 - Motor generator
 - Interior electrical system
 - 12-volt
 - 120-volt
 - Water purifier
 - Monitor panel
- b. Check the following fluid levels:
 - Transmission
 - Power steering
- c. Clean the following:
 - Upholstery
 - Counter tops
 - Cabinetry
 - Range/Oven
 - Sinks
 - Toilet
 - Screens
 - Windows
 - Vacuum carpeting

IMPORTANT: In addition to the above items, be sure all scheduled vehicle maintenance has been performed. See Maintenance Schedule folder for details. The folder includes information on required fluids and lubricants for your vehicle.

FALL AND/OR WINTER TRIP PREPARATION

Exterior

- a. Fill LP gas tank (Add methyl alcohol).
- b. Fill water tank
- c. Empty and deodorize holding tank
- d. Check that all exterior vents are unobstructed.
- e. Drain moisture from suspension air reservoir.
- f. Check operation of the following lights:
 - Headlights
 - Parking and turn signals
 - Tail and stop
 - Emergency flashers
 - Back-up lights
 - Marker and clearance
 - License
- g. Check the following fluid levels:
 - Engine oil
 - Batteries (If maintenance-free battery, check charge or test indicator)
 - Engine coolant (test freeze protection level)
 - Windshield washer reservoir
 - Motor generator oil
- h. Mount snow tires
- i. Check tire pressure and wear
- j. Wash Motorhome

Interior

- a. Check operation of the following:
 - Electro-level system
 - Wipers and washers
 - All interior lights
 - Range/Oven
 - Refrigerator

- Air conditioner
 - Automotive
 - Roof-mounted
- Vent fans
- Motor generator
- Interior electrical system
 - 12-Volt
 - 120-Volt

- b. Check operation of following (if water system is filled):
 - Water pump
 - Water heater
 - Faucets
 - Toilet—Recirculating toilet charged with recreational vehicle anti-freeze solution.
- c. Add recreational vehicle anti-freeze *(approx. ½ cup) to the following P-traps:
 - Kitchen sink
 - Bathroom sink
 - Shower drain
- d. Check the following fluid levels:
 - Transmission
 - Power steering

*Recreational vehicle anti-freeze means a non-toxic, non-flammable anti-freeze.

- e. Clean the following:
 - Upholstery
 - Counter tops
 - Cabinetry
 - Range/Oven
 - Sinks
 - Toilet
 - Screens
 - Windows
 - Vacuum carpets

IMPORTANT: In addition to the above items, be sure all scheduled vehicle maintenance has been performed. See Maintenance Schedule folder for details. The folder includes information on required fluids and lubricants for your vehicle.

GENERAL DATA AND SPECIFICATIONS

These specifications are provided for information only. Before using this information, see the cautionary and procedural material throughout the manual. For further information, refer to the maintenance manual covering this vehicle. Your GMC Motorhome dealer may also be able to offer assistance.

VEHICLE IDENTIFICATION NUMBER

In order that your vehicle may be specifically identified as to manufacturer, engine type, year designator, etc., refer to chart below.

(TYPICAL IDENTIFICATION NUMBER TZE467V100053)

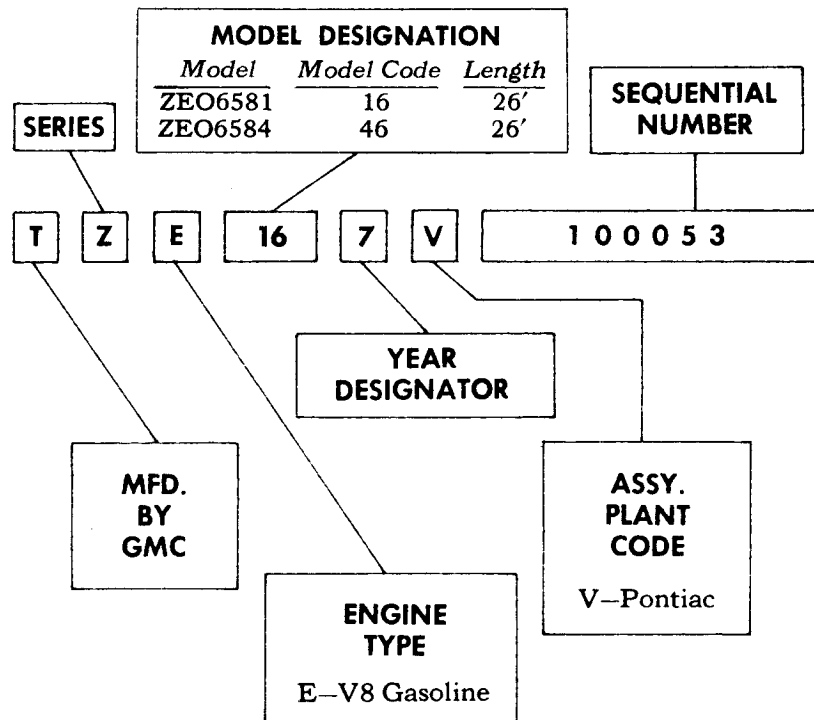

VEHICLE DIMENSIONS

Track	Front — 75.28 in.
	Rear — 82.12 in.
Wheelbase	160 in.
Length (Including optional spare tire)	26 ft.-9 in.
Width	96 in.
Height	8 ft.-1 in.
	With Roof Air Conditioner
Interior Ceiling Height	9 ft.-2 in.
	76 in.

TIRE INFORMATION

SEE "Wheels and Tires" in the SERVICE AND MAINTENANCE section of this manual and the tire placard on the glove box door.

CAPACITIES

Fuel System	Two, 25 Gal. Tanks
Cooling System	23½ Qts.
Engine Oil	5 Qts. (Including Filter 6 Qts.)
Turbo Hydramatic	Drain & Refill 4 Qts. After Complete Overhaul 12 Qts.
Final Drive (Differential)	4 Pts.
Power Steering Pump	½ Qt.
Power Steering System	1½ Qt.
LP Gas Tank	62.0 Lbs.
Living Area Water Tank	40 Gal.
Holding Tank	34 Gal.
Hot Water Tank	6 Gal.

ENGINE*

Displacement	455 cu. in.
Carburetor	4 Barrel
Compression Ratio	8.5 : 1
Bore	4.125 in.
Stroke	4.250 in.
Firing Order	1-8-4-3-6-5-7-2
High Energy Ignition System	
Spark Plugs	ACR46SX
Spark Plug Gap	0.080 in.
Dwell	Electronic

* See Tune-up label on engine for additional specifications.

BATTERIES

	<u>Type</u>
Main (Automotive) Battery	
Maintenance-Free Type	Freedom Catalog No. R89-5 No. R89-5 Rated 4000 Watts @ 0°F. (-18°C.)
Flame Arrestor Vent Cap Type	E5000 Catalog No. R91 No. R91 Rated 3350 Watts @ 0°F. (-18°C.)
Auxiliary (Living Area) Bat.	Extra Duty Catalog No. 758 No. 758 Rated 4500 Watts @ 0°F. (-18°C.)

MISCELLANEOUS

Radiator Cap (pressure opening)	9 PSI AC Type RC32
Thermostat	195°F.
Power Converter Output	45 Amps.
Furnace-Forced Air	30,000 BTU

MISCELLANEOUS (Con't)

Roof Mounted Air Conditioning

Duo-Therm

Single Unit 13,500 BTU

Dual Units

Front Unit 13,500 BTU

Rear Unit 11,000 BTU

FILTER RECOMMENDATIONS

Engine Air Cleaner AC Type A212CW

Engine Oil AC Type PF30

Transmission Oil AC Type PF160

Engine Fuel AC Type GF441

PCV Valve AC Type CV697C

Carbon Canister GM Part 7026014

Onan Motor Generator

Oil Filter GM Part 710319

Fuel Filter GM Part 707267

Air Cleaner Element GM Part 710391

VEHICLE FUSES AND CIRCUIT BREAKERS

The following fuses are located in the fuse block behind the glove box in the dash. Do not use fuses of higher amperage rating than those specified below – or property damage may result.

Usage	Name on Fuse Block	Fuse Type
Instrument Lamps	INST LPS	SFE-4
Warning Tell-Tale Lights	TELL TALES	SFE-5
Side Marker Lights I.D. & Clearance Lights Tail Lights Dome Lights License Lights	TAIL DOME	SFE-20
Cigar-Cigarette Lighter	LTR	SFE-20
Hazard Warning Lights, Step Lights	HAZ STOP	SFE-20
Auxiliary Battery Switch	AUX BAT	AGC-5
Radio, Tape Player	RADIO	AGC-10
Heater and Air Conditioner	HTR A/C	AGC-25
Windshield Washers	WASHER	AGC-10
Turn Signal Lights	DIR SIG	SFE-20

VEHICLE FUSES AND CIRCUIT BREAKERS (Con't)

Cruise Control, Back-up Lights	CRUISE BACK-UP	SFE-20
Transmission Control, Parking Brake Light, Gauges	GAUGES TRANS	AGC-10

The following circuits employ circuit breakers or have fuses located as indicated:

Headlight Circuit Breaker	Built Into Light Switch
Main Harness Fusible Link	Between Junction Block and Horn Relay
Heater Blower Fusible Link	Built Into Line At Right Access Door Near Heater Blower Relay
Hazard Signal Flasher GM No. 673499	In Clip Behind Instrument Panel at Fuel Selector Switch
Turn Signal Flasher GM No. 491392	On Steering Column
Vehicle Trouble Light AGC-10	In Line, Behind Access Door, Near Light
Air Suspension Compressor 30A Circuit Breaker	In Fuse Block
Water Pump	In Line, Near Water Pump

LIVING AREA 12-VOLT SYSTEM FUSES (ZEO 6581)

The following are located in the fuse block in the living area electrical compartment, near the hall closet. Do not use fuses of higher amperage rating than those specified below, or damage may result.

Usage	No. on Fuse Block	Fuse Type
L.H. Front Light Front Roof Vent Fan Galley Light Rear Roof Vent Fan	No. 1	AGC-15
Range Hood Vent Fan and Lights Bath Vent Fan Rear L.H. Reading Light	No. 2	AGC-15
Porch Light Aisle Lights Galley Light Water Pump Systems Monitor	No. 3	AGC-15

LIVING AREA 12-VOLT SYSTEM FUSES (ZEO 6581) (Con't)

Refrigerator Hall Light LPG Compartment Light	No. 4	AGC-15
R.H. Front Light Bath Light Rear R.H. Reading Light	No. 5	AGC-15
Toilet (Recirc.)	No. 6	AGC-15
Furnace Furnace Auxiliary Blower Oven Light Motor Generator Compartment Light	No. 7	AGC-15

LIVING AREA 12-VOLT SYSTEM FUSES (ZEO 6584)

The following are located in the fuse block in the bathroom vanity beneath the sink.

Do not use fuses of higher amperage rating than those specified below, or damage may result.

Usage	No. on Fuse Block	Fuse Type
L.H. Reading Light Rear Roof Vent Fan Bath Roof Vent Fan Galley Light	No. 1	AGC-15
Front Roof Vent Fan Range Hood Fan and Lights Hall Light	No. 2	AGC-15
Furnace Furnace Auxiliary Blower Motor Generator Compartment Light	No. 3	AGC-15
Refrigerator LPG Compartment Light Front Light	No. 4	AGC-15
Porch Light Floor Lights Water Pump	No. 5	AGC-15
Recirc. Toilet	No. 6	AGC-15
R.H. Reading Light Galley Light Switch Bath Light Systems Monitor	No. 7	AGC-15

ONAN MOTOR GENERATOR (6000 WATT—50 AMP)

Bore	3 ⁹ / ₁₆ in.
Stroke	3 in.
Oil Capacity	4 Qt.
	(With Filter Change) 4½ Qt.
Spark Plug Type	ACR46S
Spark Plug Gap020 in.
Breaker Point Gap016 in.
Ignition Timing (Running or Static)	20° BTDC
Tappet Adjustment (Engine Cold)	
Intake003 in.
Exhaust012 in.

LIGHT BULB SPECIFICATIONS (INSTRUMENT PANEL)

<u>Usage</u>	<u>Quantity</u>	<u>Bulb. No.</u>
Brake System Tell Tale	1	161
Generator Tell Tale	1	161
Park Brake Tell Tale	1	74
Cruise Control Tell Tale	1	74
Door Ajar Tell Tale	1	74
Low Fuel Tell Tale	1	74
Engine Water Tell Tale	1	74
Electro-Level Tell Tale	2	74
High Beam Indicator	1	161
Turn Signal Indicator	2	168
Instrument Cluster Lights	2	194
Speedo Cluster Lights	2	194
Dome Lights	2	211
Radio Dial (AM/FM/Stereo/Tape)	1	566
Radio Dial (Exc. AM/FM/Stereo/Tape)	1	1893
Heater Control	1	1895

LIGHT BULB SPECIFICATIONS (LIVING AREA)

<u>Usage</u>	<u>Quantity</u>	<u>Bulb. No.</u>
R.H. Front Light	2	1141
L.H. Front Light	2	1141
Kitchen Light	2	1141
Hall Light	2	1141
Porch Lights	1	1141
Compartment Lights	2	1141
Range Hood Lights	2	1156
Rear Compartment Reading Lights	2	1383
Bathroom Lights	6	1141
Aisle Lights	2	67

LIGHT BULB SPECIFICATIONS (EXTERIOR)

<u>Usage</u>	<u>Quantity</u>	<u>Bulb No.</u>
Clearance and I.D.	10	67
License	1	67
Side Markers—Front	2	194
Side Markers—Rear	2	194
Back-Up Lights	2	1156
Parking and Turn Signals	2	1157
Stop and Tail	2	1157
Headlights	2	6014

120-VOLT SYSTEM CURRENT RATING

Water Heater	8.7 Amp.
Power Converter	6.8 Amp.
Refrigerator8 Amp.
Roof Mount Air Conditioner (Front)	15.0 Amp.
(Rear)	12.0 Amp.
Vacuum Cleaner	7.0 Amp.

12-VOLT LIVING AREA COMPONENTS CURRENT RATING

R.H. Front Light	2.88 Amp.
L.H. Front Light	2.88 Amp.
Hall Light	2.88 Amp.
Rear R.H. Reading Light	1.50 Amp.
Rear L.H. Reading Light	1.50 Amp.
Kitchen Light	2.88 Amp.
Aisle Lights (Per Light)59 Amp.
Porch Light	1.44 Amp.
Bath Room Lights (ZEO 6581)	8.64 Amp.
Bath Room Lights (ZEO 6584)	4.32 Amp.
Range Hood Vent Fan and Light	6.70 Amp.
Furnace Blower	6.8 Amp.
Water Pump	3.6 Amp.
Refrigerator	6.0 Amp.
Recirculating Toilet	7.0 Amp.
Monitor Panel	2.5 Amp.
Front Vent Fan	3.50 Amp.
Rear Vent Fan	3.50 Amp.
Bath Vent Fan	3.50 Amp.
Oven Lamp	1.44 Amp.
Furnace Auxiliary Blower	3.00 Amp.
Motor Generator Compartment Lamp	1.44 Amp.
LPG Compartment Lamp	1.44 Amp.

FRONT END ALIGNMENT

NOTE: Front and rear ride height must be checked and adjusted, if necessary, before proper front end alignment can be attained. Refer to "Front Suspension" and "Rear Suspension" earlier in this manual for details on ride height.

Caster (Degrees)*	+2°	±1/2°
Camber (Degrees)**	R.H.	+1/2° ±1/4°
		L.H.	+3/4° ±1/4°
Toe (Inches)	-1/8	±1/16

*L.H. and R.H. must be within 1/2°.

**L.H. camber must be more positive (+) than R.H. camber.

OWNER ASSISTANCE

The satisfaction and goodwill of the owners of GMC Truck & Coach products are of primary concern to your dealer and the GMC Truck & Coach Division. Normally, any problems that arise in connection with the sales transaction or the operation of your vehicle will be handled by your dealer's Sales or Service Departments. It is recognized, however, that despite the best intentions of everyone concerned, misunderstandings will sometimes occur. If you have a problem that has not been handled to your satisfaction through normal channels, we suggest that you take the following steps:

STEP ONE—Discuss your problem with a member of dealership management. Frequently, complaints are the result of a breakdown in communications and can quickly be resolved by a member of the dealership management. If the problem already has been reviewed with the Sales Manager or Service Manager, contact the Dealer himself or the General Manager.

STEP TWO—Contact the GMC Truck & Coach Division Zone Office closest to you listed on page 123 (or in Canada contact the General Motors Zone Office). When it appears that your problem cannot be readily resolved by the service outlet without additional assistance, the matter should be called to the attention of the Zone's Customer Services Department and the following information provided:

- Your name, address, telephone number
- Vehicle Identification Number*
- Dealer's name and location
- Vehicle's delivery date and mileage
- Nature of problem

STEP THREE—Contact the Customer Services Manager, GMC Truck & Coach Division, 660 South Blvd. East, Pontiac, Michigan 48053 (phone 313-857-4547). (In Canada, contact the Owner Relations Manager, Oshawa, Ontario, phone 416-644-6624.) If after an additional review of all facts involved he feels that some further action can be taken, he will so instruct the Zone. In any case, your letter will be acknowledged providing GMC Truck & Coach Division's position in the matter.

When contacting the Zone or Home Office, please bear in mind that ultimately your problem likely will be resolved in the dealership utilizing the dealer's facilities, equipment and personnel. It is suggested, therefore, that you follow the above steps in sequence when pursuing a problem.

Your purchase of a GMC Truck & Coach product is greatly appreciated by both your dealer and GMC Truck & Coach Division. It is our sincere desire to assist you in any way possible to assure your complete satisfaction with your vehicle.

*Available from vehicle registration, title or vehicle identification plate.

U.S. ZONE TERRITORIES

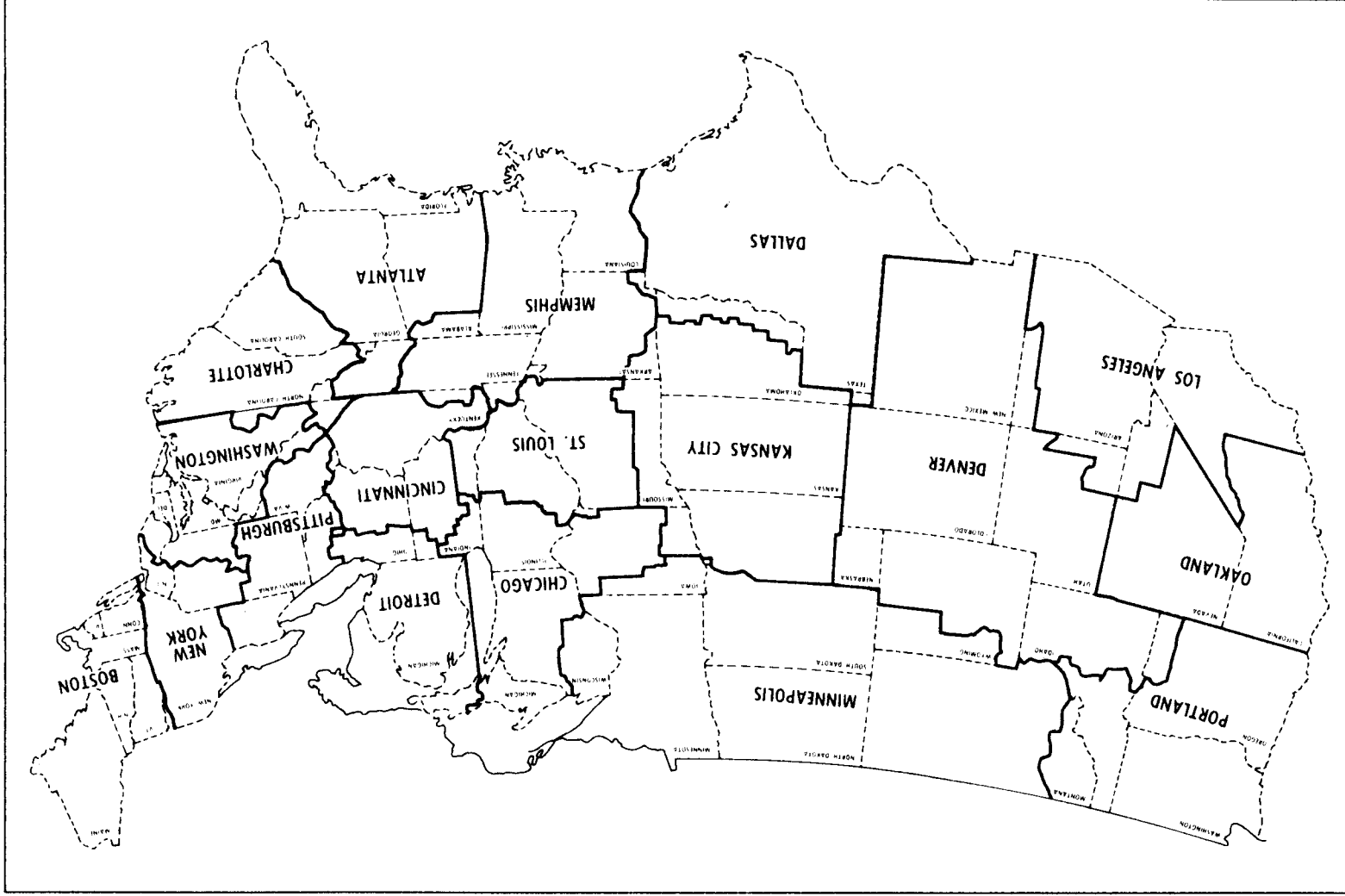

U.S. ZONE OFFICES

When calling for assistance, please ask for Customer Services Manager

ATLANTA

5730 Glenridge Drive
P.O. Box 50267
Atlanta, Georgia 30302
455-5564
Area Code 404

BOSTON

20 Cross St.
Woburn, Mass. 01801
935-6858
Area Code 617

CHARLOTTE

1914 W. Morehead
P.O. Box 8149
Freedom Station
Charlotte, N. C. 28208
332-4181-82-83
Area Code 704

CHICAGO

Commerce Plaza
2021 Spring Road
Oak Brook, Ill. 60521
Mail—P.O. Box 4392
Chicago, Ill. 60680
654-6465
Area Code 312

CINCINNATI

4010 Executive Park Drive
Suite 320
Cincinnati, Ohio 45241
841-5856
Area Code 513

DALLAS

6007 Peeler Street
P.O. Box 35187
Airlawn Station
Dallas, Texas 75235
688-5611
Area Code 214

DENVER

4715 Colorado Blvd.
Denver, Colo. 80216
320-5087
Area Code 303

DETROIT

600 S. Saginaw
Plant 4
Pontiac, Mich. 48053
857-3553
Area Code 313

KANSAS CITY

1509 N.E. Parvin Rd.
Kansas City, Mo. 64116
281-6062
Area Code 913

LOS ANGELES

8155 Van Nuys Blvd.
Suite 1030 Panorama Towers
Panorama City, Calif. 91402
873-7554
Area Code 213

MEMPHIS

3495 Lamar Ave.
Box 18467
Holiday City Sta.
Memphis, Tenn. 38118
365-9210
Area Code 901

MINNEAPOLIS

3001 Broadway N.E.
Minneapolis, Minn. 55413
331-4282
Area Code 612

NEW YORK

780 Dowd Avenue
Elizabeth, N.J. 07207
354-5860
Area Code 201

OAKLAND

10626 E. 14th Street
P.O. Box 24033
Oakland, Calif. 94603
577-0518
Area Code 415

PITTSBURGH

Two Parkway Center
875 Greentree Rd.
Pittsburgh, Pa. 15220
928-5080
Area Code 412

PORTLAND

5355 S.W. Western Avenue
Beaverton, Ore. 97005
646-8333
Area Code 503

ST. LOUIS

Suite 320
Crestwood Executive Center
St. Louis, Mo. 63126
849-0990
Area Code 314

WASHINGTON

Suite 410- Profess. Bldg.
1109 Spring St.
Silver Spring, Md. 20910
659-3166
Area Code 202

*Note: The State of Alaska
is serviced by the Portland Zone*

GENERAL MOTORS OVERSEAS DISTRIBUTION CORPORATION OFFICES

HAWAII, GUAM, AMERICAN SAMOA

General Motors Overseas
Distribution Corporation
1600 Kapiolani Boulevard
Suite 714
Honolulu, Hawaii
Mail—P.O. Box 341

MEXICO ADDRESS

General Motors de Mexico S.A.
de C.V.
Av. Ejercito Nacional No. 843
Mexico 5. D.F.
545-3921

PANAMA CANAL ZONE

General Motors Overseas
Distribution Corporation
Edificio De Diego
Esq. Calle 41 Y
Avenida Balboa
Panama, R.P.
Mail—Apartado 7872
Panama 9, Republic of Panama

PUERTO RICO, U.S. VIRGIN ISLANDS

General Motors Overseas
Distribution Corporation
Suite No. 10
Centro Comercial San Francisco
Avenida De Diego
Rio Piedras, Puerto Rico
Mail—G.P.O. Box 4382
San Juan, Puerto Rico

GM OF CANADA LIMITED—ZONE OFFICES

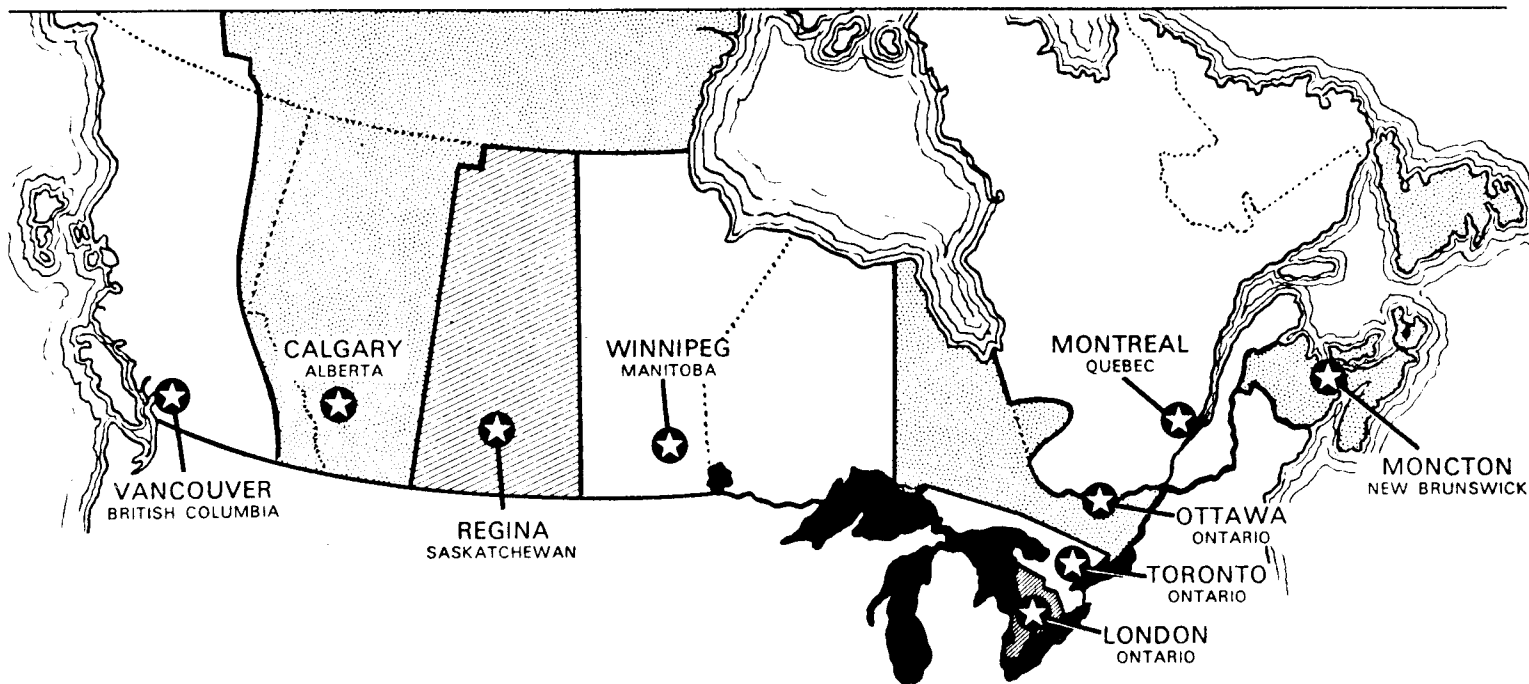

124

ZONES	ADDRESS	AREA CODE	PHONE NO.
VANCOUVER	900 Terminal Avenue Vancouver, B.C. V6A 2N6	604	684-9444
CALGARY	Box 2510 Calgary, Alberta T2P 2M7	403	243-4621
REGINA	581 Park Street Regina, Sask. S4P 3E9	306	543-2224
WINNIPEG	1345 Redwood Avenue Winnipeg, Man. R2X 0Y9	204	633-1080
LONDON	951 Pond Mills Road P.O. Box 5412 London, Ontario N6A 4P6	519	455-2400

ZONES	ADDRESS	AREA CODE	PHONE NO.
TORONTO	1200 Eglinton Ave. East Toronto Ont. M3C 1J1	416	446-5053
OTTAWA	875 Belfast Road Ottawa, Ont. K1G 0Z4	613	237-5051
MONTREAL	5000 Trans-Canada Hwy. Pointe Claire, Quebec H9R 4R2	514	697-9160
MONCTON	653 St. George Street Moncton, N.B. E1C 8M2	506	854-1500

24-HOUR PHONE ASSISTANCE

- Need answers to service or maintenance questions?
- Want to discuss vehicle specifications?
- Want to know where the GMC Motorhome dealer is located?

NORMAL BUSINESS HOURS

GMC offers you direct-to-factory communication. You can dial toll free Monday through Friday between 8:15 A.M. and 5:00 P.M. (EST) and talk with qualified personnel by calling the number below.

AFTER-HOUR INFORMATION SERVICE

If you have attempted to contact a GMC Motorhome dealer after normal business hours, without success, you may call the toll-free number below. The operator who will answer has a list of private numbers through which many dealers can be reached after hours and will give you the number and location of the nearest one.

It should be understood, however, that any charges for after-hours service assistance must be borne by the owner. In those instances where the repair qualifies under our published warranty, the dealership charge for additional services, such as for after normal business hour repairs, will be at the owner's expense.

800-521-2806

In Michigan call: 800-572-7959

EMERGENCY SERVICE

**Engine
Transmission
Final Drive (Differential)
Front Suspension**

In the event you require Emergency Service to your vehicle's engine, transmission, final drive (differential), or front suspension and a GMC Motorhome dealer is not located in the immediate geographic area – the nearest Oldsmobile dealer may be able to offer you emergency service assistance. Any work performed will be at the discretion of the particular Oldsmobile dealer contacted. You will be required to pay the servicing Oldsmobile dealer and if the vehicle is under Warranty, the repair order can be submitted to the selling GMC Motorhome dealer for review and consideration for reimbursement.

MAINTENANCE MANUAL AND PARTS BOOK

Maintenance Manual and/or Parts Book can be purchased through any GMC Motorhome dealer.

IMPORTANT FACTS YOU SHOULD KNOW ABOUT GASOLINE MILEAGE AND HOW TO IMPROVE IT

How you drive, where you drive, and when you drive all have an effect on how many miles you can get from a gallon of gasoline. The careful attention you give your vehicle as far as maintenance and repairs are concerned will also contribute importantly to fuel economy.

FUEL SELECTION

Use an unleaded gasoline or regular grade leaded gasoline. Additional details on Fuel Requirements are given in **SERVICE AND MAINTENANCE** section.

"JACKRABBIT" STARTS

Gasoline can be conserved (and engine and tire life prolonged) by avoiding unnecessarily rapid acceleration away from lights and stop signs.

STOP-AND-START DRIVING

Frequent stops and starts during a trip really cut down on your miles per gallon. Plan even your short trips to take advantage of through streets to avoid traffic lights. Pace your driving like the professional drivers to avoid unnecessary stops.

EXCESSIVE IDLING

An idling engine uses gasoline, too. If you're faced with more than a few minutes wait and you're not in traffic, it may be better to "turn off" and start again later.

SUDDEN STOPS

Sudden stops themselves don't waste gasoline, but energy is wasted as heat in braking. Energy in the form of gasoline is also needed to accelerate back to driving speed.

LUBRICANTS

A properly lubricated vehicle means less friction between moving parts. Consult this manual and the maintenance schedule for the proper lubricants to use and the lubrication intervals.

AIR CLEANER

Your vehicle receives its power from a mixture of gasoline and air. The air is taken into the system through the air cleaner so it's important to replace the air cleaner at required intervals. A dirty air cleaner reduces engine efficiency.

PROPERLY TUNED ENGINE

Overall tuning (a check on timing, spark plugs, emission control devices, etc.) can improve your vehicle's gas mileage. You just can't expect an "out-of-tune" engine to give you good gas mileage and cleaner air.

EXCESS WEIGHT

Fuel economy is related to the work the engine must do. The heavier the load, the more power it takes. Keep excess weight to a minimum by removing any personal effects or luggage from the vehicle when they are not needed.

TIRE INFLATION

Underinflation not only causes needless wear of the tires, but can also waste gasoline. It's a good idea to check tire pressures regularly.

WHEEL ALIGNMENT

"Toe in" or "toe out" has the effect of dragging your front tires sideways and causes premature tire wear. It takes power to carry this extra load and that takes gas from your tanks.

INDEX

SUBJECT	PAGE NO.	SUBJECT	PAGE NO.
A			
Absorbers, Shock	94, 95	Brakes	
Accessory Position, Ignition Switch	16	Linings	21
Adjusters, Automatic Brake	21	Master Cylinder Level	83
Air Circulation	26, 27, 52	Parking Brake	21, 22
Air Cleaner	87, 117	Power	21
Air Compressor	95	Self Adjusting	21
Air Conditioning		Warning Light	24
Automotive	26, 27	Bright Metal Cleaning	73
Roof Mount	53	B.T.U. Ratings	116, 117
Air Inlets, Ventilation	26, 27	Bulbs and Fuses	117-121
Air Suspension	95	Bunk Beds	57
Alignment, Wheel	122		
Antenna	28, 29	C	
Anti-Theft Steering Column Lock	16	Cap, Filler	
Appearance Care	69	Engine Oil	76
Automatic Transmission		Gasoline	86
Fluid Check	81, 82	Living Area Water Tank	40, 107, 108
Fluid Recommendations	81, 82	Power Steering Reservoir	83
Maintenance	82	Radiator	84-86
Operation	18	Capacities	116
Starter Safety Switch	16	Carbon Monoxide Caution	15, 35
Auxiliary Battery	26, 87-89	Carburetor, Engine	87
Auxiliary Fuel Tank	26	Air Cleaner	87
Axle, Final Drive	82, 83	Carpet Care	69
		Changing Wheels & Tires	64, 65, 91-94
		Charging System Indicator Light	23, 24
		Chassis Lubrication	81, 83
		Check List	5
		Child Restraints	11
		Chrome Protection	73, 74
		Cigar Lighter	26
		Circuit Breaker, Headlights	22, 118
		Circuit Breaker Panel	90, 97, 118
		Citizens Band Transceiver	29
		Cleaning	
		Carpet Care	69
		Exterior Finish and Trim	73
		Fabric and Interior Trim	69-71
		Spot Removal	69-71
		Vacuum Cleaner	69, 70
		Cold Weather Starting	17
		Compartment	
		Engine	77, 78
		External Utilities	36, 75
		Front Access	76
		Glove	6
		Living Area Water	41
		L.P. Gas	96, 97
		Complaint Procedure	123
B			
Bathroom			
Drains	107		
Roof Fan	52		
Roof Vent	52, 53		
Shower	50		
Sink	50		
Toilets	48, 49		
Warm Air Duct	51		
Batteries			
Emergency Starting	61		
Fluid Level	88		
Gas Caution	88, 89		
Living Area (Use)	35		
Location	87, 88		
Battery Boost Switch	26		
Battery Charger, Power Converter	36		
Bearings, Rear Wheel	94		
Beds	56-59		
Before Driving Your Motorhome	5		
Belt Restraints	9, 10, 72		
Blower, Ventilating	26, 27		
Body Identification Number	115		

SUBJECT	PAGE NO.	SUBJECT	PAGE NO.
Conditioner, Air		Emergency Exit	67
Automotive	26	Emergency, In Case of	61
Roof Mounted	53	Brake System Warning Light	24
Converter, Power	36	Charging System Warning Light	23
Converting Davo to Beds	57	Electro-Level System	32-34
Converting Dinette to Bed	56, 59	Emergency Starting	61
Converting Side Facing Settee to Bed	58	Hazard Warning Flasher	61
Cooling System		Jacking Instructions	64
Care	84-86	Jump Starting	61
Coolant Recommendation	84	Overheating Engine	63, 85
Overheating Caution	64	Pushing to Start	61
Cruise Control	19, 20	Service	127
Customer Service	123	Towing	65
		Engine Access	78
D		Engine Coolant Tank	84
Davo	57	Engine Compartment	77
Defrosters	27	Engine Firing Order	116
Differential, Final Drive	82	Engine Oil	
Dimensions, Vehicle	115	Capacity	116
Dimmer Switch, Headlamp	22	Change Interval	79
Dinette	56, 59	Dip Stick	81
Directional Signal	19	Filter	79, 117
Distributor	89	Pressure Gauge	23
Dome Lights	25	Recommendation	79
Drainage System	109	Entrance Door	6
Draining Holding Tank	107	Ethylene Glycol Coolant	84
Draining Living Area Water System	107	Exhaust Gas Caution	15, 35
Drain Traps	109	Parked with Engine Running	15
Driver Check List	5	Exit, Emergency	67
Driver's Seat	7	Exterior Finish Care	73
Driving Tips	14	Exterior Receptacle	39
Dump Hose	107	External Power Connection	36
Dump Valve	107	External Utilities Compartment	36
Dusty Condition, Operation Under	39, 79, 87	External Water Connection	40
E		F	
Electrical Systems		Fabric Care	69
Batteries	26, 35, 87, 116	Filling L.P. Gas Tank	96
Battery Boost Switch	26	Filling Living Area Water Tank	40
Battery Charger, Power Converter	36	Filter, Water Tank	109
Bulbs, Light	120, 121	Filters	117
Charging System Indicator Light	23	Final Drive Differential	82
Converter, Power	36	Finish Care, Exterior	73
Diode Assembly	26	Fire Extinguisher	67
External Power	36	Flammable Cleaning Solvents	69
Lighting System	37	Flashers	
Living Area Elec. Compartment	36	Hazard Warning	61, 118
Living Area Fuse Block	97, 118, 119	Turn Signal	19, 118
Motor Generator	38, 99, 120	Flooded Engine	17
Electro-Level System	32-34	Floor Controls	21
Emergency Equipment	13	Fluid Capacities	116

SUBJECT	PAGE NO.	SUBJECT	PAGE NO.
Fluid Levels		Holding Tank	107
Batteries	88	Winter Travel	111
Brake Master Cylinder	83	Horn	19
Engine Oil	81		
Final Drive	82	I	
Power Steering	83	Identification Lights	25, 121
Radiator	84	Identification Number, Vehicle	115
Transmission	81	Identification Plate, Vehicle	2
Foreign Countries, Operation in	12	Ignition, Keys and Lock	6, 16
Four Way Hazard Warning Flasher	61, 118	In Case of Emergency	61
Front Access Doors	76	Indicator Lights	24
Front Suspension	94	Infant Restraining Methods	11
Fuel		Inflation Pressure, Tire	91
Filler Cap Location	86	Instrument Panel	22
Gauge	22	Interior Appearance Care	69
Motor Generator	39		
Recommendations	86	J	
Tank Selector Switch	26	Jack Usage Instructions	64
Fumes, Engine Exhaust	15	Jump Starting	61
Furnace	54		
Furniture	56	K	
Fuses		Keys	6
Living Area Chart	118, 119	Kitchen Facilities	43
Living Area Location	97	Power Range Hood	44
Vehicle Chart	117, 118	Range/Oven	44
Vehicle Location	90	Refrigerator	43
		Sink	47
G		Knocking Engine	86
Gas, L.P.	96		
Gas Station Information	Inside Back Cover	L	
Gasoline (See Fuel)	86	Lane Change and Turn Signal	19, 118
Generator Indicator Light	23	Lap Belts	9
Generator Motor	38, 99, 120	Latch, Door	6
General Data & Specifications	115	Leveling Vehicle	32
Glass and Mirrors	72	Lighter, Cigar	26
Glove Box	6	Lights	
Gross Vehicle Weight (GVW)	1	Aisle	37, 120
		Brake Warning	24
H		Bright Beam Indicator	22
Hazard Warning Light	61	Bulb Chart	120, 121
Headlight		Charging System	23
Adjustment	89	Dome	25
Flicker	22	Engine Coolant	24, 25
High Beam Dimmer Switch	22	Hazard Flasher	61
High Beam Indicator	22	Headlight Aim	90
Replacement	89	Headlight Circuit Breaker	118
Switch	25	Headlight Switch	25
Heater, Operation	27	Living Area	37, 120
Hitches, Trailer	11	Marker & Clearance	25, 121
Hoisting Vehicle	78	Parking Brake	21

SUBJECT	PAGE NO.	SUBJECT	PAGE NO.
Porch	37	Parking	17
Tail Lights	25	Brake	21
Tell Tale Warning	24	Lights	24
Turn Signal Indicator	19, 22	Pilot Lights	
Linings, Brake	21	Oven	44
Living Area Electrical Compartment	36	Range	44
Living Area Electrical System	35	Plugs, Spark	89
Living Area Facilities Caution	35	Polishing and Waxing	73
Living Area Lighting	37	Porch Light	37
Loading, Vehicle	1	Power	
Locks	6	Brakes	21
Low Lead Fuels	86	Converter and Battery Charger	36
Low Temperature Operation	17, 39	Vents	52
L.P. Gas System	96	Steering	19, 83
Lubrication		Pressure, Tire Inflation	91
Details	79		
		R	
M		Radiator and Coolant	84
Maintenance		Radio	
Appearance Care	69	AM	27
Manual	127	AM/FM	28
Schedule	76	Antenna	28, 29
Master Cylinder, Brake	83	CB	29
Marker Lights	25	Mobile Transmitter	31
Metal Cleaners	46, 69, 73, 74	Stereo	28
Methods of Restraining Children	11	Tape System	28
Mirrors, Rear View	5, 6	Raising Vehicle With Jack	64
Mobile Radio Transmitter	31	Range Hood	44
Monitor Panel	37	Range/Oven	44
Motor Generator	38, 99, 120	Rear Suspension	95
		Rear Wheel Bearings	94
O		Recirculating Toilet	49, 106
Odometer	22	Refilling	
Oil		L.P. Gas Tank	96
Additives	79	Water Tank	40
Checking Engine Oil Level	81	Refrigerator	43
Filter	79	Restraints, Child	11
Motor Generator	99, 120	Roof	
Pressure Gauge	23	Mounted Air Conditioning	53
Recommendations	79	Vents	51, 52
Transmission	81	Rotation, Tire	92
Viscosity	79, 99		
Onan Motor Generator	38, 99, 120	S	
Operation in Foreign Countries	12	Safety	
Oven Operation	44	Belt Restraints	9
Overheated Engine		Sanitizing Water System	110
Temperature Gauge	22	Schedule	
What To Do	22, 63, 85	Maintenance	76
Owner Assistance	123	Schematics	41, 100-103, 109
		Seat	
P		Adjustments	7
Paint, Care and Touch Up	73	Belts	9-11

SUBJECT	PAGE NO.
Self Adjusting Brakes	21
Service and Maintenance	75
Service Information, After-Hour	127
Settee	58
Sewer Connection	107
Shock Absorbers	94, 95
Shower	50
Signals, Turn	19
Sinks	
Bathroom	50
Kitchen	47
Solvents, Recommended Cleaning	69
Spark Knock	86
Spark Plugs	89
Speakers, Radio	27-31
Specifications	
Air Cleaner	117
Alignment, Front End	122
Amperes	121
Batteries	116
Body	115
Capacities	116
Dimensions	115
Filters	117
Fuses	117-119
Light Bulbs	120, 121
Miscellaneous	116, 117
Motor Generator	120
PCV Valve	117
Vehicle Identification	115
Speedometer and Odometer	22
Spot Cleaner	69, 70, 74
Stains, Removal Of	71
Starting Engine	17
Cold Weather	17
Emergency	61
Steering	
Column Controls	16
Linkage	83
Maintenance	80, 83
Power	19
Tilt	19
Wheel	16, 19
Stereo, Radio and Tape	28
Storage of Motorhome	
Long Term	111
Motor Generator	113
Short Term	111
Winter	112
Suspension	
Front	94
Rear	95
Swivel Seats	7, 8

SUBJECT	PAGE NO.
T	
Tape System, Stereo	28
Tell Tale Lights	24, 120
Temperature	
Control, Cooling and Heating	26, 27
Gauge	22, 24
Theft Protection	16
Thermostat	
Engine Cooling	86, 116
Living Area Furnace	54
Tilt Steering Wheel	19
Tips	
Driving	14
Trip	13
Water Saving	50
Vehicle Trip Preparation	113
Tire	
Care	91
Changing	93, 94
Inflation Pressure	91
Inspection	92, 93
Load Limit	93
Replacement	93
Rotation	92
Snow	92
Traction	92
Tread Wear	92, 93
Toilet	
Standard	48, 105
Recirculating	49, 106
Towing	65
Trailer Hauling	11, 12
Transmission	
Braking Effect On Hills	18
Checking Fluid Level	81
Maintenance	81, 82
Shift Controls	18
Transmitter, Mobile Radio	31
Tread Wear Indicators	93
Trim Care Interior	69
Turn Signals	19
U	
Upholstery and Carpet	69
Under Coating	74
V	
Vacuum Cleaner	69
Vehicle Identification	2, 115

SUBJECT	PAGE NO.	SUBJECT	PAGE NO.
Vehicle Storage		Waxing	73
Long Term	111	Weight Distribution	1
Short Term	111	Wheel Alignment	122
Winter	112	Wheel Bearings	
Ventilation	51, 52	Rear	94
Vents	52	Wheel Changing	93
Volatile Cleaning Solvents, Caution	69	Wheel, Tilt Steering	19
		Windows	52, 72
W		Screens	72
Warning Flasher, Hazard	61	Windshield	
Warning Lights		Defrosting	27
Brake	24	Washers	25
Charging System	23	Wipers	25
Cluster	24	Winterization	111
Low Fuel	24	Wiring Schematics	100-103
Washers, Windshield	25	Wrecker, Towing	65
Washing	73		
Water		Z	
External Connection	40	Zone Offices	
Filter	109	Canada	126
Heater	42, 108	Mexico	125
Pump	42, 108	United States	125
System	40, 107-111	Zone Territories	
Tank	40, 107-111	Canada	126
Treatment Unit	47, 112	United States	124

GAS STATION INFORMATION

Refer to **SERVICE AND MAINTENANCE** section for details on removal and installation of engine cover, placing vehicle on suitable hoist, etc.

CAUTION

To help prevent the possibility of fire or explosion, turn off LP gas supply at the LP gas tank and be sure all pilots are out, before filling gasoline tanks.

Always check that fluid inputs are made into the correct filler opening to help avoid serious personal injury and property damage.

GAS CAP—Located on the left side of the vehicle, directly under the driver's window. See gas cap removal procedure in **SERVICE AND MAINTENANCE** section.

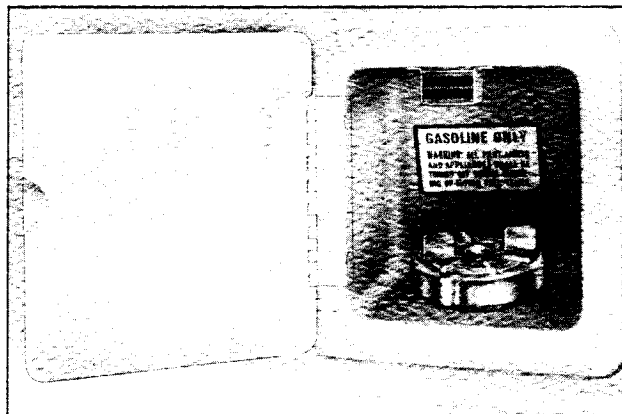

Gas Cap Location

GASOLINE RECOMMENDATION — Use an unleaded gasoline or regular grade leaded gasoline. Additional details on Fuel Requirements are given in the **SERVICE AND MAINTENANCE** section.

FRONT ACCESS DOORS—Release by turning latch knob to the left to loosen.

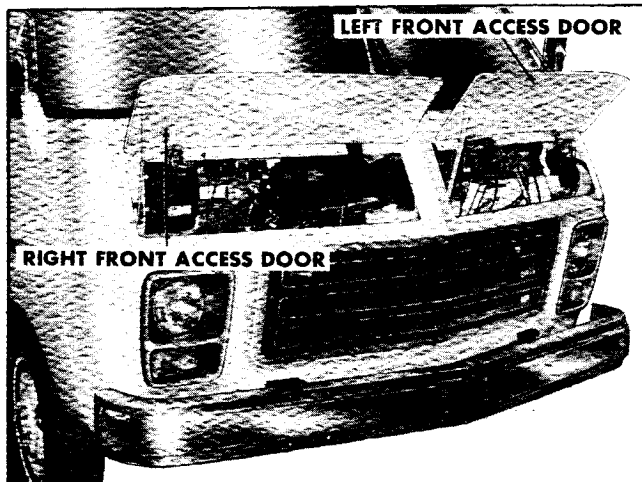

Front Access Doors

ENGINE OIL DIPSTICK—Located inside the left front access door. Check oil level as the last operation in a fuel stop. Maintain between "ADD" and "FULL" marks on dipstick.

ENGINE OIL RECOMMENDATION — Use only high quality SE oils. The chart in the **SERVICE AND MAINTENANCE** section will serve as a guide for selecting proper oil viscosity.

TIRE INFLATION PRESSURES — Check at least monthly. Keep inflated to pressures shown on tire placard affixed on the inside of the glove compartment door.

WINDSHIELD WASHER — Check reservoir fluid level regularly. Use a washer fluid, such as GM Optikleen or equivalent.

BATTERIES — Check fluid level monthly. When fluid level is low, add colorless, odorless drinking water to bring level to split ring in filler openings. If your vehicle is equipped with a Maintenance-Free battery the charge or test indicator provides information for testing purposes only.